

Alco Controls

Components for the Refrigeration Industry



Product Selection Catalogue

Note:

The components listed in this catalogue are not released for use with caustic, poisonous or flammable substances. ALCO CONTROLS cannot be held responsible for any damage caused by using these substances.

Preferred products are marked by **bold** letters.
They are available immediately from stock.

General Information

This catalogue covers only products which can be used in the Refrigeration industry. Products mainly used in Air-Conditioning applications are described in data sheets. Please ask your local ALCO supplier.

Technical data are correct at time of printing. Updates may occur and should you need confirmation of a specific value please contact ALCO CONTROLS stating clearly the information required.

ALCO CONTROLS cannot be held responsible for errors in capacities, dimensions etc., stated herein. Products, specifications and data in this literature are subject to change without notice.

The information given herein is based on data and tests which ALCO CONTROLS believes to be reliable and which are in accordance with today's technical knowledge. It is intended for use by persons having the appropriate technical knowledge and skill, at their own discretion and risk. Since conditions of use are outside ALCO's control we cannot assume liability for results obtained or any damages which may occur due to improper application.

Electrical Control Valves

Electronic Controllers and Sensors

Thermo[®]-Expansion Valves

Solenoid Valves

Mechanical Pressure Regulators

Pressure Controls and Thermostats

System Protectors and Moisture Indicators

Oil Management Components

Ball Valves, Miscellaneous

Accessories & Spare Parts

Appendix



Electronic Control

Electrical Control Valves

Pulse Modulated Expansion Valves	Series EX2	7
Electrical Control Valves	Series EX4, EX5, EX6, EX7, EX8	10

Electronic Controllers and Sensors

Superheat Controllers	Series EC3-X32 / EC3-X33	34
Digital Superheat Controllers	Series EC3-D72 / EC3-D73	34
Stand Alone Driver Module	Series EXD-U	35
Display Case and Coldroom Controllers	Series EC1	36
Display Case and Universal Controllers	Series EC2	38
Coldroom Controllers	Series EC3-300	41
Condenser- and Condensing Unit Controllers	Series EC2-500, -700	44
Rack and Condenser Controllers	Series EC3-600, -700, -800, -900	47
Network Accessories		51
Electronic Smart Starter	Series ESC	50
Pressure Transmitters	Series PT4	52
Fan Speed Controllers	Series FSY	53
Fan Speed Controllers	Series FSP	57
Monitoring Server	Series EMS-300	59

Conventional Control

Thermo[®]-Expansion Valves

Thermo [®] -Expansion Valves	Series TI	64
Thermo [®] -Expansion Valves	Series TX6	70
Thermo [®] -Expansion Valves	Series T	72
Thermo [®] -Expansion Valves	Series ZZ	77
Liquid Injection Valves	Series L	80
Liquid Injection Valves	Series 935	82
Flanges for Valves		86

Solenoid Valves

Coils and Cable Assemblies		89
2-Way Solenoid Valves	Series 110 RB, 200 RB, 240 RA	90
2-Way Solenoid Valves	Series 540 RA	91
3-Way Solenoid Valves	Series M36	94

Mechanical Pressure Regulators

Hot Gas Bypass Regulators	Series ACP	97
Hot Gas Bypass Regulators	Series CPHE	97
Head Pressure Control Valves	Series HP	99
Evaporator Pressure Regulators	Series PRE	101
Crankcase Pressure Regulators	Series PRC	102

	Page
Temperature and Pressure Controls	103
Single Pressure Controls	Series PS1 106
Dual Pressure Controls	Series PS2 108
Pressure Controls	Series PS3 / Standard types 110
Pressure Controls	Series PS3 / Special types 112
Differential Pressure Controls	Series FD 113 113
Thermostats	Series TS1 114
System Protectors and Others	
System Protectors, Moisture Indicators	119
Bi-Flow Filter Driers	Series BFK 121
Filter Driers	Series ADK-Plus 122
Filter Driers	Series FDB 124
Filter Drier Shells	Series ADKS-Plus 126
Filter Drier Shells with Quick-cap	Series FDS-24 127
Filter Drier Shells with Quick-cap	Series FDS-48 128
Suction Line Filters and Filter Driers	Series ASF and ASD 131
Suction Line Filter and Filter Drier Shells	Series BTAS 132
Moisture Liquid Indicators	Series MIA 134
Moisture Liquid Indicators	Series AMI 135
Oil Management Components	137
Electronic Oil Level Management Systems	Series OM3 / OM4 139
Oil Separators	Series OS 141
Ball Valves and Miscellaneous	143
Suction Accumulators	Series A 144
Ball Valves	Series BVA / BVS 145
Acid Test Kits	Series AOK 146
Accessories & Spare Parts	147
Controller Kit Parts List	152
Appendix	153
Conversion Table	154
Connection Specifications	154
Saturation Pressure Table for Refrigerants	155
CE per Pressure Vessel Directive - CE 97/23 EC	156



Keyword Register

Series	Description	Page	Series	Description	Page
110 RB	2-Way Solenoid Valve	90	H		
200 RB	2-Way Solenoid Valve	90	H 48/100	Block for ADKS	126
240 RA	2-Way Solenoid Valve	90	HP	Head Pressure Control	99
540 RA	2-Way Solenoid Valve	91	L	Liquid Injection Valve	80
935	Liquid Injection Valve	82	M		
A	Suction Accumulator	144	M36	3-Way Solenoid Valve	94
ACP	Hot Gas Bypass Regulator	97	MIA	Moisture Liquid Indicator	134
ADK-Plus	Filter Drier	122	O		
ADKS-Plus	Filter Drier Shell	126	OM3 / OM4	Oil Level Management System	139
AF	Filter Core for BTAS	132	OS	Oil Separator	141
AFD	Filter Drier Core for BTAS	132	P		
AMI	Moisture Liquid Indicator	135	PRC	Evaporator Pressure Regulator	102
AOK	Acid Alert Kit	146	PRE	Crankcase Pressure Regulator	101
ASC	Coil for Solenoids	87	PS1	Pressure Controls	106
ASF	Suction Line Filter	131	PS2	Dual Pressure Controls	108
ASD	Suction Line Filter Drier	131	PS3	Pressure Controls	110
B			PT4	Pressure Transmitter	53
BFK	Bi-Flow Filter Drier	121	S		
BTAS	Suction Line Filter Drier Shell	132	S 24	Core for FDS-24	127
BVA / BVS	Ball Valves	145	S 48	Core for ADKS, FDS-48	126
C			T		
CPHE	Hot Gas Bypass Regulator	97	TI(E)	Thermo®-Expansion Valve	72
E			TS1	Thermostat	114
EC1	Display Case/Coldroom Controller	36	TX6	Thermo®-Expansion Valve	70
EC2-1, -2, -3	Display Case Controller	38	W		
EC2-5, -7	Condenser-, CU-Controller	44	W 24	Block for FDS-24	127
EC3-3	Coldroom Controller	41	W 48/100	Block for ADKS	126
EC3-6 ... -9	Rack and Condenser Controller	47	Z		
EC3-D72/D73	Digital Superheat Controllers	34	ZZ	Thermo®-Expansion Valve	77
EC3-X32/X33	Superheat Controllers	34			
ECP-024	Uninterruptible Power Supply	35			
EMS	Monitoring Server	59			
ESC	Electronic Smart Starter	52			
EX2	Pulse Modulated Expansion Valve	7			
EX4 .. EX8	Electrical Control Valves	10			
EXD-U	Stand-alone Univ. Driver Module	35			
F					
F 24	Filter for FDS-24	127			
FD 113	Differential Pressure Control	113			
FDB	Filter Drier	124			
FDS-24	Filter Drier Shell	127			
FDS-48	Filter Drier Shell	128			
FSE	Fan Speed Control Module	57			
FSP	Fan Speed Power Module	57			
FSY	Electronic Fan Speed Controller	55			

Electrical Control Valves

Electrical Control Valves

Electrical Control Valve Technology

Thermostatic expansion valves and mechanical regulator valves have been used in the refrigeration and air conditioning industry to control superheat and refrigerant mass flow since its very beginning. As today's systems require improved energy efficiency, tighter temperature control, wider range of operating conditions and incorporate new features like remote monitoring and diagnostics, the application of electronically operated valves becomes mandatory. Only they offer the controls performance necessary to meet these needs.

Electrical control valves are actuators only. For operation in a system they need sensors, valve drivers and controllers, see next chapter.

EX2 is designed for pulse width modulation. It is applicable to all common HCFC and HFC refrigerants and for subcritical CO₂ applications and is used mainly for refrigeration applications such as display cases. The EX2 valve is a slide type solenoid valve with an orifice for expansion. It is either completely open or completely closed. One common valve body can be combined with 6 interchangeable orifices to cover 7 capacity ranges.

EX4/EX5/EX6/EX7/EX8 consist of two main internal assemblies, the valve and the stepper motor. The stepper motor is located next to the electrical plug and connected directly to the slide and cage assembly of the valve. Similar to the technology used in compressors, the motor is exposed to refrigerant and lubricant and the materials used are identical

to the ones in compressor motors. The housing of the motor and valve assembly is made from stainless steel and fully hermetic, utilising exclusively brazing and welding technologies and eliminating all gaskets.

This design offers several technical advantages such as proportional linear mass flow and a wide capacity range.

A common feature of all ALCO electrical control valves is the positive shut-off function, which eliminates the need for additional solenoid valves.

Valve Selection

For **EX2** the published table quotes capacities at 100% duty cycle. i.e. valve open continuously. However, it is recommended to operate the valve at partial load (50-80%) to allow for system load fluctuations.

For **EX4/EX5/EX6/EX7/EX8** all published capacities are maximum and there are no reserve capacities. Each valve should be selected for the highest possible capacity of the system. A wide range regulation (10 ... 100%) with one slide orifice for each valve is achievable.

To facilitate **valve dimensioning** for other than the standard conditions ALCO offers an Excel based **Selection Tool**. This can be ordered from all Copeland sales offices or downloaded from www.emersonclimate.eu.

Selection Table for Electrical Control Valves and applicable Controllers

Valve Type	Function	Capacity kW R407C	Feature	Min. Evaporating Temperature °C	Main Application		Applicable Controller	
						Page		Page
EXM EXL	Expansion Valve	5 .. 20.7	Uni polar stepper motor driven	-30	Heat pumps, Air Conditioning Close control	s. data sheet	customized	s. data sheet
EX2	Exp. Valve	1.0 .. 18.7	PWM	-40	Refrigeration	7	EC2	38
EX4 EX5 EX6 EX7 EX8	Expansion Valve	2 .. 17.4 5 .. 53 15 .. 126 35 .. 347 100 .. 925	Bi polar stepper motor driven	-100 -100 -100 -50 -50	Heat pumps, Refrigeration, A/C, Water Chillers	11	EC3-X.. Superheat Contr. EC3-3.. Cold room Contr.	34 41
EX4 EX5 EX6 EX7 EX8	Capacity Control	4.9 16 37 131 399	Bi polar stepper motor driven	-100 -100 -100 -100 -100	Hot gas bypass regulator	19	EXD-U.. Universal Contr.	35
EX6 EX7 EX8	Capacity Control	3.9 14 42	Bi polar stepper motor driven	-50	Suction pressure / crankcase pressure regulator	20	EXD-U.. Universal Contr.	35
EX5 EX6 EX7 EX8	Liquid Mass Flow Control	18 43 153 463	Bi polar stepper motor driven	-	Condensing pressure and liquid regulator	22	EXD-U.. Universal Contr.	35
EX6 EX7 EX8	Heat Reclaim	11 39 119	Bi polar stepper motor driven	-	Heat Reclaim applications	24	EXD-U.. Universal Contr.	35

Electrical Control Valves Series EX2

Pulse width modulated with exchangeable orifices
Can be used with EC2 display case controllers (see page 41)

Features

- Pulse width modulated
- Shut off function eliminates the necessity of a separate solenoid valve
- Dampened plunger reduces noise effects of water hammer
- One valve body can be combined with 6 orifices to make 7 capacity ranges up to 18.7 kW (R 407C)
- Applicable to all common refrigerants (HCFC, HFC) and for subcritical CO₂ applications
- Long lifetime, high reliability
- PS: 40bar, TS: -40 to +65°C



**EX2
with Orifice**

Selection Chart

Type	Part No.	Function	Capacity Q _n at 100% open Valve (kW) *					
			R 134a	R 22	R 404A	R 507	R 407C	R 744
EX2-M00	801 091	10 mm inlet / 12 mm outlet ODF	13.3	17.2	12.1	12.1	18.7	35.0
EX2-I00	801 090	3/8" inlet / 1/2" outlet ODF						
EXO-004	801 089	Orifice 4	8.5	10.9	7.7	7.7	11.8	22.2
EXO-003	801 088	Orifice 3	5.6	7.2	5.1	5.1	7.8	14.6
EXO-002	801 087	Orifice 2	3.3	4.3	3.0	3.0	4.7	8.7
EXO-001	801 086	Orifice 1	2.5	3.2	2.3	2.3	3.5	6.5
EXO-000	801 085	Orifice 0	1.2	1.6	1.1	1.1	1.7	3.3
EXO-00X	801 084	Orifice X	0.7	0.9	0.6	0.6	1.0	1.8
ASC 24V	801 062	Coil 24 VAC 50-60HZ (10W)						

*) Orifice should be selected at max. 80% of Q_n to allow covering the load fluctuation.

The nominal capacity (Q_n) is based on the following conditions:

Refrigerant	Evaporating temperature	Condensing temperature	Subcooling
R 407C	+4°C (dew point)	+38°C bubble point / +43°C dew point	1K
R 22, R 134a, R 404A, R 507	+4°C	+38°C	1K
R 744	-40°C	-10°C	1K

For other operating conditions an Excel based selection tool can be downloaded from www.emersonclimate.eu, or use correction factors with following formula:

$$Q_n = Q_o \times K_t \times K_{\Delta p}$$

- Q_n: Nominal valve capacity
 Q_o: Required cooling capacity
 K_t: Correction factor for evaporating and liquid temperature
 K_{Δp}: Correction factor for pressure drop at valve



Liquid temperature entering Valve °C	Correction Factor K_t											
	R 134a											
	Evaporating Temperature °C											
	+15	+10	+5	0	-5	-10	-15	-20	-25	-30	-40	
+55	1.21	1.23	1.26	1.29	1.33	1.36	1.39	1.43	1.47	1.52	1.62	
+50	1.13	1.15	1.17	1.20	1.23	1.26	1.28	1.32	1.36	1.39	1.48	
+45	1.06	1.08	1.10	1.12	1.15	1.17	1.19	1.22	1.26	1.29	1.37	
+40	0.99	1.01	1.03	1.05	1.08	1.10	1.12	1.14	1.17	1.20	1.27	
+35	0.94	0.96	0.97	0.99	1.01	1.03	1.05	1.07	1.10	1.12	1.18	
+30	0.89	0.91	0.92	0.94	0.96	0.98	0.99	1.01	1.03	1.06	1.11	
+25	0.85	0.86	0.87	0.89	0.91	0.92	0.94	0.95	0.97	1.00	1.04	
+20	0.81	0.82	0.83	0.85	0.89	0.88	0.89	0.91	0.92	0.94	0.98	
+15	0.77	0.78	0.79	0.81	0.82	0.84	0.84	0.86	0.88	0.89	0.93	
+10		0.75	0.76	0.77	0.78	0.80	0.81	0.82	0.84	0.85	0.89	
+5			0.73	0.74	0.75	0.76	0.77	0.78	0.80	0.81	0.84	
0				0.71	0.72	0.73	0.74	0.75	0.76	0.78	0.81	
-5					0.69	0.70	0.71	0.72	0.73	0.74	0.77	
-10						0.68	0.68	0.69	0.70	0.71	0.74	

Correction Factor $K_{\Delta p}$																								
Δp	3.5	4.0	4.5	5.0	5.5	6.0	6.5	7.0	7.5	8.0	8.5	9.0	10.0	11.0	12.0	13.0	14.0	15.0	16.0	17.0	18.0	19.0	20.0	21.0
$K_{\Delta p}$	1.34	1.25	1.18	1.12	1.07	1.02	0.98	0.95	0.91	0.88	0.86	0.83	0.79	0.75	0.72	0.69	0.67	0.65	0.63	0.61	0.59	0.57	0.56	0.55

Liquid temperature entering Valve °C	Correction Factor K_t											
	R 404A											
	Evaporating Temperature °C											
	+15	+10	+5	0	-5	-10	-15	-20	-25	-30	-35	-40
+55	1,42	1,46	1,50	1,55	1,61	1,68	1,75	1,83	1,92	2,01	2,13	2,25
+50	1,23	1,26	1,30	1,34	1,38	1,43	1,48	1,54	1,61	1,68	1,75	1,84
+45	1,10	1,12	1,15	1,18	1,22	1,26	1,30	1,34	1,39	1,45	1,51	1,57
+40	0,99	1,02	1,04	1,07	1,09	1,13	1,16	1,20	1,24	1,28	1,33	1,38
+35	0,91	0,93	0,95	0,97	1,00	1,02	1,05	1,08	1,11	1,15	1,19	1,23
+30	0,84	0,86	0,88	0,90	0,92	0,94	0,96	0,99	1,02	1,05	1,08	1,11
+25	0,79	0,80	0,82	0,83	0,85	0,87	0,89	0,92	0,94	0,97	0,99	1,02
+20	0,74	0,75	0,77	0,78	0,80	0,81	0,83	0,85	0,87	0,90	0,92	0,95
+15	0,70	0,71	0,72	0,73	0,75	0,76	0,78	0,80	0,82	0,84	0,86	0,88
+10		0,67	0,68	0,69	0,71	0,72	0,74	0,75	0,77	0,79	0,81	0,83
+5			0,65	0,66	0,67	0,68	0,70	0,71	0,73	0,74	0,76	0,78
0				0,63	0,64	0,65	0,66	0,68	0,69	0,71	0,72	0,74
-5					0,61	0,62	0,63	0,65	0,66	0,67	0,69	0,70
-10						0,60	0,61	0,62	0,63	0,64	0,65	0,67

Correction Factor $K_{\Delta p}$																								
Δp	3.5	4.0	4.5	5.0	5.5	6.0	6.5	7.0	7.5	8.0	8.5	9.0	10.0	11.0	12.0	13.0	14.0	15.0	16.0	17.0	18.0	19.0	20.0	21.0
$K_{\Delta p}$	1,74	1,63	1,54	1,46	1,39	1,33	1,28	1,23	1,19	1,15	1,12	1,09	1,03	0,98	0,94	0,90	0,87	0,84	0,81	0,79	0,77	0,75	0,73	0,71

Liquid temperature entering Valve °C	Correction Factor K_t											
	R 744											
	Evaporating Temperature °C											
	+5	+0	-5	-10	-15	-20	-25	-30	-35	-40		
+5	1,12	1,10	1,09	1,08	1,08	1,07	1,07	1,07	1,08	1,08		
0		1,02	1,01	1,01	1,00	1,00	1,00	1,00	1,00	1,01		
-5			0,95	0,94	0,94	0,94	0,94	0,94	0,94	0,94		
-10				0,89	0,89	0,88	0,88	0,88	0,89	0,89		
-15					0,84	0,84	0,84	0,84	0,84	0,84		
-20						0,80	0,80	0,80	0,80	0,80		
-25							0,76	0,76	0,76	0,76		
-30								0,73	0,73	0,73		
-35									0,7	0,70		
-40										0,67		

Correction Factor $K_{\Delta p}$																								
Δp	5.0	6.0	7.0	8.0	9.0	10.0	11.0	12.0	13.0	14.0	15.0	16.0	17.0	18.0	19.0	20.0	21.0	22.0	23.0	24.0	25.0	26.0	27.0	28.0
$K_{\Delta p}$	1,81	1,65	1,53	1,43	1,35	1,28	1,22	1,17	1,12	1,08	1,05	1,01	0,98	0,95	0,93	0,91	0,88	0,86	0,84	0,83	0,81	0,79	0,78	0,77

Liquid temperature entering Valve °C	Correction Factor K_t Evaporating Temperature °C																							
	R 22																							
	+15	+10	+5	0	-5	-10	-15	-20	-25	-30	-35	-40												
+55	1.17	1.19	1.20	1.22	1.24	1.25	1.27	1.29	1.32	1.34	1.37	1.39												
+50	1.11	1.12	1.13	1.15	1.16	1.18	1.20	1.22	1.24	1.26	1.28	1.30												
+45	1.05	1.06	1.07	1.08	1.10	1.12	1.13	1.15	1.17	1.18	1.20	1.23												
+40	1.00	1.01	1.02	1.03	1.04	1.06	1.07	1.09	1.10	1.12	1.14	1.16												
+35	0.95	0.96	0.97	0.98	0.99	1.01	1.02	1.03	1.05	1.06	1.08	1.10												
+30	0.91	0.92	0.93	0.94	0.95	0.96	0.97	0.98	1.00	1.01	1.03	1.04												
+25	0.87	0.88	0.89	0.89	0.91	0.92	0.93	0.94	0.95	0.96	0.98	0.99												
+20	0.83	0.84	0.85	0.86	0.87	0.88	0.89	0.90	0.91	0.92	0.93	0.95												
+15	0.80	0.81	0.81	0.82	0.83	0.84	0.85	0.86	0.87	0.88	0.89	0.91												
+10		0.78	0.78	0.79	0.80	0.81	0.82	0.83	0.84	0.85	0.86	0.87												
+5			0.75	0.76	0.77	0.78	0.79	0.79	0.80	0.81	0.82	0.83												
0				0.73	0.74	0.75	0.76	0.77	0.77	0.78	0.79	0.80												
-5					0.72	0.72	0.73	0.74	0.75	0.75	0.76	0.77												
-10						0.70	0.71	0.71	0.72	0.73	0.74	0.74												
Correction Factor $K_{\Delta p}$																								
Δp	3.5	4.0	4.5	5.0	5.5	6.0	6.5	7.0	7.5	8.0	8.5	9.0	10.0	11.0	12.0	13.0	14.0	15.0	16.0	17.0	18.0	19.0	20.0	21.0
$K_{\Delta p}$	1.59	1.49	1.40	1.33	1.27	1.22	1.17	1.13	1.09	1.05	1.02	0.99	0.94	0.90	0.86	0.83	0.80	0.77	0.75	0.72	0.70	0.68	0.67	0.65

Liquid temperature entering Valve °C	Correction Factor K_t Evaporating Temperature °C																							
	R 507																							
	+15	+10	+5	0	-5	-10	-15	-20	-25	-30	-35	-40												
+55	1.39	1.43	1.47	1.52	1.57	1.62	1.69	1.76	1.83	1.92	2.02	2.12												
+50	1.22	1.24	1.28	1.31	1.35	1.40	1.44	1.49	1.55	1.61	1.68	1.76												
+45	1.09	1.11	1.14	1.17	1.20	1.23	1.27	1.31	1.36	1.40	1.46	1.52												
+40	0.99	1.01	1.03	1.06	1.08	1.11	1.14	1.17	1.21	1.25	1.29	1.34												
+35	0.91	0.93	0.95	0.97	0.99	1.01	1.04	1.07	1.10	1.13	1.16	1.20												
+30	0.85	0.86	0.88	0.89	0.91	0.93	0.96	0.98	1.01	1.03	1.06	1.09												
+25	0.79	0.80	0.82	0.83	0.85	0.87	0.89	0.91	0.93	0.95	0.98	1.01												
+20	0.74	0.75	0.77	0.78	0.79	0.81	0.83	0.85	0.87	0.89	0.91	0.93												
+15	0.71	0.71	0.72	0.73	0.75	0.76	0.78	0.79	0.81	0.83	0.85	0.87												
+10		0.67	0.68	0.69	0.70	0.72	0.73	0.74	0.76	0.78	0.79	0.81												
+5			0.64	0.65	0.67	0.68	0.69	0.70	0.72	0.73	0.75	0.76												
0				0.62	0.63	0.64	0.65	0.66	0.68	0.69	0.70	0.72												
-5					0.60	0.61	0.62	0.63	0.64	0.65	0.66	0.68												
-10						0.58	0.59	0.60	0.61	0.62	0.63	0.64												
Correction Factor $K_{\Delta p}$																								
Δp	3.5	4.0	4.5	5.0	5.5	6.0	6.5	7.0	7.5	8.0	8.5	9.0	10.0	11.0	12.0	13.0	14.0	15.0	16.0	17.0	18.0	19.0	20.0	21.0
$K_{\Delta p}$	1.75	1.64	1.54	1.46	1.40	1.34	1.28	1.24	1.19	1.16	1.12	1.09	1.03	0.99	0.94	0.91	0.87	0.84	0.82	0.79	0.77	0.75	0.73	0.71

Liquid temperature entering Valve °C	Correction Factor K_t Evaporating Temperature °C																							
	R 407C																							
	+15	+10	+5	0	-5	-10	-15	-20	-25															
+55	1.26	1.28	1.31	1.34	1.37	1.40	1.44	1.48	1.52															
+50	1.15	1.17	1.19	1.22	1.24	1.27	1.30	1.33	1.37															
+45	1.06	1.08	1.10	1.12	1.14	1.17	1.19	1.22	1.25															
+40	0.99	1.01	1.02	1.04	1.06	1.08	1.11	1.13	1.16															
+35	0.93	0.94	0.96	0.98	0.99	1.01	1.03	1.05	1.07															
+30	0.88	0.89	0.90	0.92	0.93	0.95	0.97	0.99	1.01															
+25	0.83	0.84	0.85	0.87	0.88	0.90	0.91	0.93	0.95															
+20	0.79	0.80	0.81	0.82	0.84	0.85	0.86	0.88	0.90															
+15	0.75	0.76	0.77	0.78	0.80	0.81	0.82	0.84	0.85															
+10		0.73	0.74	0.75	0.76	0.77	0.78	0.80	0.81															
+5			0.71	0.72	0.73	0.74	0.75	0.76	0.77															
0				0.69	0.70	0.71	0.72	0.73	0.74															
-5					0.67	0.68	0.69	0.70	0.71															
-10						0.65	0.66	0.67	0.68															
Correction Factor $K_{\Delta p}$																								
Δp	3.5	4.0	4.5	5.0	5.5	6.0	6.5	7.0	7.5	8.0	8.5	9.0	10.0	11.0	12.0	13.0	14.0	15.0	16.0	17.0	18.0	19.0	20.0	21.0
$K_{\Delta p}$	1.81	1.69	1.59	1.51	1.44	1.38	1.33	1.28	1.23	1.19	1.16	1.13	1.07	1.02	0.98	0.94	0.90	0.87	0.84	0.82	0.80	0.78	0.76	0.74

Electrical Control Valves Series EX4, EX5, EX6, EX7, EX8

Features

- Multifunction as expansion valve, hot gas bypass, suction gas throttling, head pressure, liquid level actuator etc
- Fully hermetic design (no thread joints between valve body and motor compartment)
- Applicable to all common refrigerants (HCFC, HFC) and for subcritical CO₂ applications
- Stepper motor driven
- Short opening and closing time
- Very fast full stroke time
- High resolution and excellent repeatability
- Positive shut-off function to eliminate use of additional solenoid valve
- Bi-flow versions for heat pump applications
- High linear flow capacity
- Extremely wide capacity range (10 ... 100%)
- Continuous modulation of mass flow, no stress (liquid hammering) in the refrigeration circuit
- Direct coupling of motor and valve for high reliability (no gear mechanism)
- Ceramic slide and port for highly accurate flow and minimal wear
- Europe patent No. 0743476, USA patent No. 5735501, Japan patent No. 28225789
- Balanced force design
- Corrosion resistant stainless steel body and stainless steel connections
- PS: 45 bar
- TS: Uniflow: -50 to +100°C, Biflow: -40 to +80°C

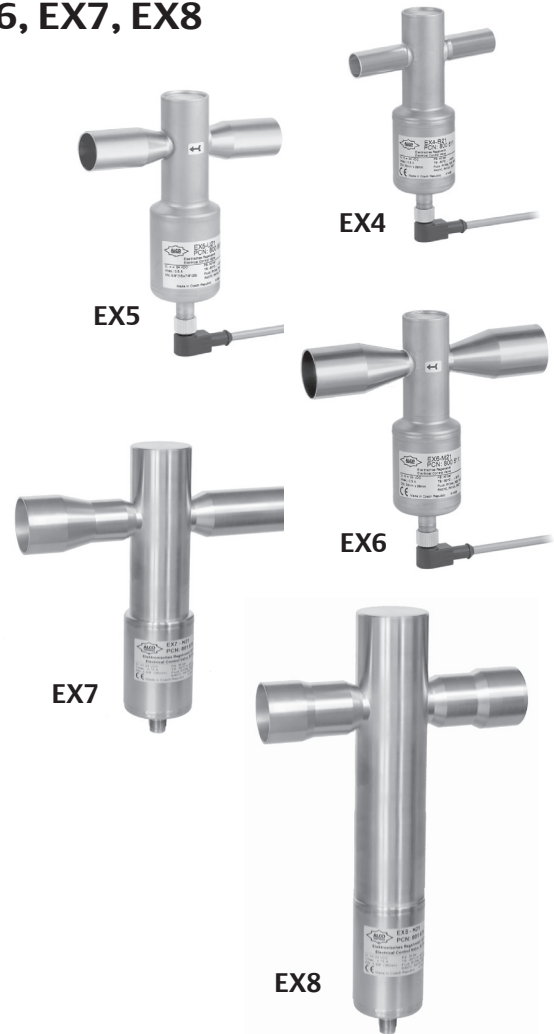

Selection Chart Capacities see following pages

Type	Part No.	Flow Pattern	Capacity	Inlet connection	Outlet connection	Electrical connection
EX4-I21	800 615	Uni-flow	10 ... 100%	3/8" ODF	5/8" ODF	M12 Plug
EX4-M21	800 616			10mm ODF	16mm ODF	
EX5-U21	800 618			5/8" (16mm) ODF	7/8" (22mm) ODF	
EX6-I21	800 620			7/8" ODF	1-1/8" ODF	
EX6-M21	800 621			22mm ODF	28 mm ODF	
EX7-I21	800 624			1-1/8" ODF	1-3/8" ODF	
EX7-M21	800 625			28mm ODF	35mm ODF	
EX8-M21	800 629			42mm ODF	42mm ODF	
EX8-U21	800 630			1-3/8" (35mm) ODF	1-3/8" (35mm) ODF	
EX8-I21	800 631			1-5/8" ODF	1-5/8" ODF	
EX4-U31	800 617	Bi-flow (Heat Pump)		5/8" (16mm) ODF	5/8" (16mm) ODF	
EX5-U31	800 619			5/8" (16mm) ODF	7/8" (22mm) ODF	
EX6-I31	800 622			1-1/8" ODF	1-1/8" ODF	
EX6-M31	800 623			28mm ODF	28mm ODF	
EX7-U31	800 626			1-3/8" (35mm) ODF	1-3/8" (35mm) ODF	

Cable and Connector Assemblies

Type	Part No.	Temperature Range	Length	Connector type to valve	Connector type to driver or controller	Illustration
EX5-N15	804 650	-25 ... +80°C	1.5 m	M12, 4 pins	Loose wires	
EX5-N30	804 651		3.0 m			
EX5-N60	804 652		6.0 m			
EX5-L60	804 655	-50 ... +80°C	6.0 m			

Capacity Data

Application Expansion Valve and Liquid Injection Valve - Nominal Capacity (kW)

Valve Type	R 407C	R 22	R 134a	R 404A	R 410A	R 23 *	R 124 *	R 744
EX4	2 .. 17.4	2 .. 16.5	1 .. 12.8	1 .. 11.5	2 .. 19.3	2 .. 17.8	1 .. 9.2	3 .. 33.5
EX5	5 .. 53	5 .. 50	4 .. 39	4 .. 35	6 .. 58	5 .. 54	3 .. 28	10 .. 102
EX6	15 .. 126	15 .. 120	10 .. 93	10 .. 84	15 .. 140	13 .. 130	7 .. 67	24 .. 244
EX7	35 .. 347	35 .. 330	25 .. 255	25 .. 230	40 .. 385	-	-	70 .. 670
EX8	100 .. 925	90 .. 880	70 .. 680	60 .. 613	100 .. 1027	-	-	180 .. 1789

*) Biflow versions are not released for R 124 and R 23
Capacity for biflow versions identical in both flow directions.

The nominal capacity (Qn) is based on the following conditions:

Refrigerant	Evaporating temperature	Condensing temperature	Subcooling
R 407C	+4°C (dew point)	+38°C bubble point / +43°C dew point	1K
R 22, R 134a, R 404A, R 410A	+4°C	+38°C	1K
R 124	+20°C	+80°C	1K
R 23	-60°C	-25°C	1K
R 744	-40°C	-10°C	1K

Guideline for selection of electrical control valves as expansion valves

ALCO Selection Tool

For easy and quick selection of Electrical Control Valves an Excel based selection tool can be downloaded from the Internet at www.emersonclimate.eu, or use the quick selection tables on the following pages.

The following guideline should be taken into consideration in order to obtain full advantages of the control valves:

- **Published capacities are maximum and there are no reserve capacities**
- Larger size of valve leads to shorter pull down period and shorter travel time i.e. faster response. For example, EX7 has maximum 3.2 seconds travel time. The valve has approximately 1.6 seconds travel time at 50% capacity operation.

Example:

System with R407C having two different operating conditions:

- 110 kW capacity at +4°C/+50°C with two stages compressor at 50% / 100% capacity
- 137 kW capacity at +4°C/+30°C with two stages compressor at 50% / 100% capacity

EX6 with 126 kW covers condition A, however is not sufficient to cover condition B. It is recommended to select larger valve i. e. EX7 with 337 kW at condition A and 293 kW at condition B.

Condition A:

$$\text{Full load ratio} = 110 / 337 = 33\%$$

$$\text{Partial load ratio} = (110/2) / 337 = 16\%$$

Condition B:

$$\text{Full load ratio} = 137 / 293 = 47\%$$

$$\text{Partial load ratio} = (137/2) / 293 = 23\%$$

The capacity ratios of system to valve are in all conditions higher than 10%. It is recommended to use EX7 rather than EX6.

Application Expansion Valve and Liquid Injection Valve

Condensing Temperature °C	R 134a													Valve Type
	Extended capacity kW													
	Evaporating Temperature °C													
	15	10	5	0	-5	-10	-15	-20	-25	-30	-35	-40	-45	
60	13	13	13	13	13	13	12	12	12	12	11	11	11	EX4
	39	39	39	39	39	39	38	37	36	35	34	33	32	EX5
	93	94	94	94	93	92	90	89	87	84	82	79	77	EX6
	255	257	258	257	255	252	248	243	237	231	224	217	210	EX7
	679	686	688	686	680	672	661	648	633	616	598	580	560	EX8
55	12	13	13	13	13	13	13	12	12	12	12	11	11	EX4
	38	39	39	39	39	39	38	38	37	36	35	34	33	EX5
	91	92	93	94	93	93	92	90	88	86	84	82	80	EX6
	249	253	256	257	256	254	251	247	242	237	231	225	218	EX7
	663	676	683	685	683	678	670	659	647	632	616	599	582	EX8
50	12	12	13	13	13	13	13	12	12	12	12	12	11	EX4
	36	38	38	39	39	39	38	38	37	37	36	35	34	EX5
	87	90	91	92	93	92	92	91	89	88	86	84	81	EX6
	238	246	250	253	254	253	251	249	245	240	235	229	223	EX7
	636	655	668	675	677	676	671	663	653	640	627	611	595	EX8
45	11	12	12	12	12	13	12	12	12	12	12	12	11	EX4
	34	36	37	38	38	38	38	37	37	37	36	35	35	EX5
	81	85	88	90	91	91	91	90	89	88	86	84	82	EX6
	223	234	241	246	248	249	249	247	244	240	236	231	226	EX7
	595	623	642	655	662	664	663	658	651	641	629	616	602	EX8
40	10	11	11	12	12	12	12	12	12	12	12	12	11	EX4
	31	33	35	36	37	37	37	37	37	36	36	35	34	EX5
	74	79	83	85	87	88	89	88	88	87	85	84	82	EX6
	202	217	227	234	239	242	243	242	240	238	234	230	225	EX7
	539	578	606	625	638	645	647	646	641	634	625	614	601	EX8
35	9	10	10	11	11	12	12	12	12	12	12	11	11	EX4
	27	30	32	34	35	35	36	36	36	36	35	35	34	EX5
	63	71	76	80	83	84	85	86	85	85	84	83	81	EX6
	173	194	209	219	226	231	234	235	234	232	230	227	223	EX7
	463	517	556	584	604	616	623	625	624	620	613	604	594	EX8
30	7	8	9	10	11	11	11	11	11	11	11	11	11	EX4
	20	25	28	30	32	33	34	34	34	34	34	34	33	EX5
	49	60	67	73	76	79	81	82	82	82	81	80	79	EX6
	133	164	184	199	210	217	221	224	225	224	223	221	217	EX7
	356	436	492	531	559	578	590	597	600	599	595	588	580	EX8
25	3	6	8	9	9	10	10	11	11	11	11	11	11	EX4
	10	18	23	26	29	30	31	32	33	33	33	32	32	EX5
	23	44	55	63	69	72	75	77	78	78	78	77	76	EX6
	63	121	152	173	188	198	206	210	213	214	213	212	210	EX7
	169	322	406	462	501	529	548	560	567	570	569	565	559	EX8
20		2	5	7	8	9	9	10	10	10	10	10	10	EX4
		5	16	21	25	27	28	29	30	31	31	31	31	EX5
		12	38	51	58	64	68	70	72	73	73	73	73	EX6
		34	105	139	160	175	186	193	197	200	201	201	199	EX7
		90	281	370	427	467	495	514	526	533	536	535	532	EX8
15				4	6	7	8	9	9	9	9	9	9	EX4
				13	19	22	25	26	27	28	28	29	29	EX5
				32	45	53	59	62	65	67	68	68	68	EX6
				87	123	145	161	171	178	183	186	187	187	EX7
				231	328	388	428	456	475	488	495	498	498	EX8
10					3	5	6	7	8	8	8	9	9	EX4
					9	16	20	22	24	25	26	26	26	EX5
					22	38	47	52	56	59	61	62	62	EX6
					61	104	128	144	155	162	167	170	171	EX7
					162	277	341	384	413	432	445	452	455	EX8

Typical Order Package

- 1) Valve EX4, EX5, EX6, EX7 or EX8 (see page 10),
Plug and cable assembly EX5-N60 Part No. 804 652
- 2) Controller Kit EC3-X32/EC3-X33 (s. page 34 and overview on page 152)
- 3) optional ECD-002 Display Unit with connection cable (s. page 34)

Application Expansion Valve and Liquid Injection Valve

Condensing Temperature °C	R 22													Valve Type
	Extended capacity kW Evaporating Temperature °C													
	15	10	5	0	-5	-10	-15	-20	-25	-30	-35	-40	-45	
60	17	17	18	18	18	18	18	18	18	17	17	17	17	EX4
	51	52	53	54	54	54	54	54	53	53	52	52	51	EX5
	123	126	128	129	130	130	130	129	128	127	126	124	122	EX6
	337	345	351	355	357	358	357	356	353	350	345	340	335	EX7
	900	921	936	946	952	954	953	948	941	932	921	908	893	EX8
55	16	17	17	18	18	18	18	18	18	18	17	17	17	EX4
	50	51	52	53	54	54	54	54	54	53	53	52	52	EX5
	119	123	126	128	129	130	130	130	129	128	127	126	124	EX6
	328	339	346	352	355	357	358	357	356	353	350	345	340	EX7
	876	903	923	938	948	953	955	953	949	941	932	921	908	EX8
50	16	16	17	17	18	18	18	18	18	18	18	17	17	EX4
	48	50	51	52	53	54	54	54	54	54	53	53	52	EX5
	114	119	123	125	127	129	129	129	129	128	127	126	125	EX6
	314	327	337	345	350	354	355	356	355	353	351	347	343	EX7
	838	873	899	919	933	943	948	949	947	942	935	925	914	EX8
45	15	16	16	17	17	17	17	18	18	18	17	17	17	EX4
	45	47	49	51	52	52	53	53	53	53	53	52	52	EX5
	107	113	118	121	124	126	127	128	128	127	127	126	124	EX6
	295	311	324	334	341	346	349	351	351	350	348	346	342	EX7
	787	830	864	890	909	923	932	936	937	934	929	922	912	EX8
40	13	15	15	16	16	17	17	17	17	17	17	17	17	EX4
	41	44	46	48	50	51	52	52	52	52	52	52	51	EX5
	98	106	111	116	119	122	124	125	125	125	125	124	123	EX6
	270	290	306	319	328	335	340	343	345	345	344	342	339	EX7
	719	774	817	850	875	894	907	915	919	919	916	911	903	EX8
35	12	13	14	15	16	16	16	17	17	17	17	17	17	EX4
	36	40	43	45	47	49	50	50	51	51	51	51	50	EX5
	86	96	103	109	113	117	119	121	122	122	122	122	121	EX6
	237	264	284	300	312	321	327	332	335	336	336	335	333	EX7
	632	703	757	799	831	856	873	885	893	896	896	893	888	EX8
30	10	11	13	14	15	15	16	16	16	16	16	16	16	EX4
	29	35	39	42	44	46	47	48	49	49	49	49	49	EX5
	70	83	93	100	106	110	113	116	117	118	118	118	118	EX6
	194	229	256	276	291	303	312	318	322	325	326	326	324	EX7
	516	611	682	735	776	808	831	848	859	866	869	868	865	EX8
25	7	9	11	12	13	14	15	15	15	16	16	16	16	EX4
	20	28	33	37	40	43	44	46	46	47	47	48	48	EX5
	47	67	80	90	97	102	106	109	112	113	114	114	114	EX6
	130	184	220	246	266	281	292	301	307	311	313	314	314	EX7
	347	491	587	656	709	749	779	802	818	829	835	837	836	EX8
20		6	9	10	12	13	13	14	14	15	15	15	15	EX4
		18	26	32	36	39	41	42	44	45	45	45	46	EX5
		43	63	76	85	93	98	102	105	107	108	109	109	EX6
		117	173	209	235	254	269	280	288	294	298	300	300	EX7
		312	461	557	627	678	718	747	768	784	793	799	801	EX8
15			5	8	10	11	12	13	13	14	14	14	14	EX4
			15	24	30	34	37	39	40	42	42	43	43	EX5
			37	58	71	81	88	93	97	100	102	103	104	EX6
			101	160	196	222	241	256	266	274	279	283	285	EX7
			269	426	524	593	644	682	710	731	745	754	759	EX8
10				4	7	9	10	11	12	13	13	13	13	EX4
				12	22	28	31	34	36	38	39	40	40	EX5
				29	53	66	76	82	87	91	94	96	97	EX6
				80	145	182	208	227	241	251	258	263	267	EX7
				214	386	485	554	604	642	669	689	702	711	EX8

Typical Order Package

- 1) Valve EX4, EX5, EX6, EX7 or EX8 (see page 10),
Plug and cable assembly EX5-N60 Part No. 804 652
- 2) Controller Kit EC3-X32/EC3-X33 (s. page 34 and overview on page 152)
- 3) optional ECD-002 Display Unit with connection cable (s. page 34)

Application Expansion Valve and Liquid Injection Valve

Condensing Temperature °C	R 404A / R 507													Valve Type
	Extended capacity kW													
	Evaporating Temperature °C													
	15	10	5	0	-5	-10	-15	-20	-25	-30	-35	-40	-45	
60	9	9	9	9	9	9	9	8	8	8	7	7	6	EX4
	28	28	28	28	28	27	26	25	24	23	22	21	20	EX5
	68	68	68	67	66	65	63	61	58	56	53	50	47	EX6
	186	187	186	184	181	177	172	166	160	153	145	137	129	EX7
	495	498	496	491	482	471	458	443	425	407	387	366	344	EX8
55	10	10	10	10	10	10	10	9	9	9	8	8	8	EX4
	30	31	31	31	30	30	29	29	28	27	26	25	23	EX5
	72	73	74	74	73	72	70	69	67	64	62	59	56	EX6
	198	201	202	202	200	197	193	188	182	176	169	162	154	EX7
	527	535	538	537	533	525	514	501	486	470	451	432	411	EX8
50	10	10	11	11	11	11	10	10	10	10	9	9	9	EX4
	31	32	32	32	32	32	32	31	30	30	29	28	27	EX5
	74	76	77	78	78	77	76	75	73	71	69	66	64	EX6
	203	208	211	213	213	211	208	204	200	194	188	181	174	EX7
	541	555	564	567	567	562	555	545	532	518	501	484	465	EX8
45	10	10	11	11	11	11	11	11	11	10	10	10	9	EX4
	31	32	33	33	33	33	33	33	32	32	31	30	29	EX5
	74	77	79	80	80	80	80	79	78	76	74	72	69	EX6
	201	210	215	219	220	220	219	216	212	208	202	196	190	EX7
	537	559	574	583	587	586	582	575	566	553	539	524	506	EX8
40	10	10	11	11	11	11	11	11	11	11	11	10	10	EX4
	29	31	33	33	34	34	34	34	34	33	32	32	31	EX5
	71	75	78	80	81	82	82	81	81	79	78	76	74	EX6
	193	205	214	219	223	225	225	223	221	217	213	208	202	EX7
	515	547	570	585	594	598	598	595	588	578	567	553	538	EX8
35	9	10	10	11	11	11	11	11	11	11	11	11	11	EX4
	27	30	31	33	34	34	34	34	34	34	33	33	32	EX5
	65	71	75	79	81	82	83	83	82	81	80	79	77	EX6
	178	195	207	215	221	225	226	226	225	223	219	215	210	EX7
	474	519	551	574	590	599	603	604	600	594	585	573	560	EX8
30	8	9	10	10	11	11	11	11	11	11	11	11	11	EX4
	23	27	30	31	33	34	34	34	34	34	34	33	33	EX5
	56	65	71	75	78	81	82	83	83	82	81	80	79	EX6
	153	177	194	206	215	221	224	226	226	225	223	219	215	EX7
	409	472	517	550	573	588	598	603	603	600	593	584	573	EX8
25	6	8	9	10	10	11	11	11	11	11	11	11	11	EX4
	17	23	27	29	31	32	33	34	34	34	34	34	33	EX5
	42	55	64	70	74	78	80	81	82	82	81	80	79	EX6
	114	150	174	191	204	213	218	222	224	224	223	220	217	EX7
	305	400	465	510	543	566	582	592	596	597	593	587	579	EX8
20	1	5	7	8	9	10	10	11	11	11	11	11	11	EX4
	3	16	22	26	28	30	32	33	33	33	33	33	33	EX5
	8	40	53	62	68	73	76	78	80	80	80	80	79	EX6
	21	108	146	170	187	200	208	214	218	219	220	218	216	EX7
	56	289	388	453	499	532	555	571	580	585	585	582	576	EX8
15			5	7	8	9	10	10	10	11	11	11	11	EX4
			15	21	25	28	29	31	32	32	32	33	32	EX5
			37	51	60	66	71	74	76	77	78	78	78	EX6
			101	139	164	181	194	202	208	212	213	214	213	EX7
			268	371	437	484	516	540	555	564	569	569	566	EX8
10				5	7	8	9	9	10	10	10	10	10	EX4
				14	20	24	26	28	30	31	31	31	31	EX5
				33	48	57	64	68	71	73	75	75	75	EX6
				91	131	156	174	186	195	201	204	206	206	EX7
				242	350	417	464	496	519	535	544	548	549	EX8

Typical Order Package

- 1) Valve EX4, EX5, EX6, EX7 or EX8 (see page 10),
Plug and cable assembly EX5-N60 Part No. 804 652
- 2) Controller Kit EC3-X32/EC3-X33 (s. page 34 and overview on page 152)
- 3) optional ECD-002 Display Unit with connection cable (s. page 34)

Application Expansion Valve and Liquid Injection Valve

Condensing Dew point °C	Temperature Bubble point °C	R 407C													Valve Type
		Extended capacity kW Evaporating Temperature °C													
		15	10	5	0	-5	-10	-15	-20	-25	-30	-35	-40	-45	
64	60	16	17	17	17	17	17	16	16	16	15	15	15	14	EX4
		50	51	51	51	51	50	50	49	48	47	46	45	43	EX5
		119	120	121	121	121	119	118	116	114	112	109	106	103	EX6
		328	332	333	333	332	329	325	320	314	308	301	293	285	EX7
		874	884	889	889	885	877	867	854	838	821	802	781	759	EX8
59	55	17	17	17	17	17	17	17	17	16	16	16	15	15	EX4
		50	51	52	52	52	52	51	51	50	49	48	47	46	EX5
		120	122	123	124	124	123	122	121	119	117	114	112	109	EX6
		330	336	339	341	341	339	336	332	328	322	315	308	301	EX7
		879	895	904	909	908	904	897	886	873	858	840	821	801	EX8
54	50	16	17	17	17	17	17	17	17	17	17	16	16	16	EX4
		50	51	52	52	53	53	52	52	51	51	50	49	48	EX5
		118	121	123	125	125	125	125	123	122	120	118	116	113	EX6
		326	334	340	343	345	345	343	340	336	331	325	319	312	EX7
		869	891	906	915	919	919	914	907	896	883	868	851	832	EX8
50	45	16	16	17	17	17	17	17	17	17	17	17	16	16	EX4
		48	50	51	52	53	53	53	52	52	51	51	50	49	EX5
		115	119	122	124	125	125	125	125	124	122	120	118	116	EX6
		316	327	336	341	344	346	345	344	341	337	332	326	320	EX7
		843	873	894	909	918	921	920	916	908	897	884	869	853	EX8
45	40	15	16	16	17	17	17	17	17	17	17	17	17	16	EX4
		46	48	50	51	52	52	52	52	52	52	51	50	49	EX5
		109	114	118	121	123	124	125	125	124	123	121	120	118	EX6
		300	315	326	334	339	342	344	343	341	338	334	330	324	EX7
		801	840	870	891	905	913	916	915	910	902	891	878	864	EX8
40	35	14	15	16	16	17	17	17	17	17	17	17	17	16	EX4
		42	45	48	49	50	51	52	52	52	51	51	50	50	EX5
		101	108	113	117	120	122	123	123	123	122	121	120	118	EX6
		278	297	312	323	330	335	338	339	338	337	334	330	325	EX7
		742	793	832	860	880	894	901	904	902	897	889	879	866	EX8
35	30	12	14	15	15	16	16	16	17	17	17	17	16	16	EX4
		38	42	45	47	48	49	50	51	51	51	50	50	49	EX5
		90	99	106	111	115	118	119	120	121	120	120	119	117	EX6
		248	273	292	306	317	324	329	331	332	331	329	326	323	EX7
		661	729	779	817	844	864	876	883	885	884	878	870	860	EX8
30	25	10	12	13	14	15	15	16	16	16	16	16	16	16	EX4
		32	37	41	44	46	47	48	49	49	49	49	49	48	EX5
		75	88	97	103	108	112	115	116	117	117	117	116	115	EX6
		207	241	266	285	299	309	316	320	322	323	322	320	317	EX7
		552	644	710	760	796	823	841	853	860	861	859	854	846	EX8
26	20	7	10	12	13	14	14	15	15	16	16	16	16	15	EX4
		23	30	36	39	42	44	46	47	47	48	48	48	47	EX5
		54	72	85	94	100	105	108	111	112	113	113	113	112	EX6
		148	199	233	258	276	289	299	305	309	312	312	311	309	EX7
		395	530	621	687	735	770	796	814	825	831	832	829	824	EX8
21	15	7	9	11	12	13	14	14	15	15	15	15	15	15	EX4
		21	29	34	38	40	42	44	44	45	45	46	46	46	EX5
		50	69	81	90	96	101	104	106	108	108	109	108	108	EX6
		137	189	223	247	265	277	287	293	297	299	299	299	298	EX7
		365	503	594	658	705	740	764	781	791	796	797	795	795	EX8
16	10	6	9	11	12	13	13	14	14	14	14	14	14	14	EX4
		19	27	32	36	38	40	42	43	43	43	43	43	43	EX5
		45	64	76	85	91	96	99	101	103	103	103	103	103	EX6
		123	176	210	234	251	264	273	279	282	284	284	284	284	EX7
		329	470	561	624	670	704	727	743	753	757	758	758	758	EX8

Typical Order Package

- 1) Valve EX4, EX5, EX6, EX7 or EX8 (see page 10),
Plug and cable assembly EX5-N60 Part No. 804 652
- 2) Controller Kit EC3-X32/EC3-X33 (s. page 34 and overview on page 152)
- 3) optional ECD-002 Display Unit with connection cable (s. page 34)

Application Expansion Valve and Liquid Injection Valve

Condensing Temperature °C	R 410A Extended capacity kW													Valve Type
	Evaporating Temperature °C													
	15	10	5	0	-5	-10	-15	-20	-25	-30	-35	-40	-45	
60	17	17	18	18	18	18	18	18	18	18	17	17	17	EX4
	51	52	53	54	54	54	54	54	53	53	52	51	50	EX5
	123	126	129	130	131	131	131	130	129	127	125	123	120	EX6
	339	348	354	358	360	361	360	358	354	350	344	338	331	EX7
	-	-	-	-	-	-	-	-	-	-	-	-	-	EX8
55	18	18	19	19	19	19	19	19	19	19	19	18	18	EX4
	53	55	56	57	57	58	58	58	57	57	56	55	54	EX5
	127	132	135	137	138	139	139	139	138	137	135	133	131	EX6
	350	362	370	377	381	383	383	382	380	377	372	366	360	EX7
	935	965	988	1005	1016	1021	1023	1020	1014	1005	992	978	961	EX8
50	18	18	19	19	20	20	20	20	20	20	20	19	19	EX4
	53	55	57	58	59	60	60	60	60	59	59	58	57	EX5
	128	133	137	140	142	144	145	145	144	143	142	140	138	EX6
	351	366	377	386	392	396	398	398	397	394	391	386	380	EX7
	936	975	1006	1029	1045	1056	1061	1062	1059	1052	1043	1030	1015	EX8
45	17	18	19	19	20	20	20	20	20	20	20	20	20	EX4
	52	54	57	58	60	60	61	61	61	61	61	60	59	EX5
	124	131	136	141	144	146	147	148	148	147	146	145	143	EX6
	342	361	375	387	395	401	405	407	407	405	403	399	394	EX7
	913	962	1001	1031	1054	1070	1080	1085	1085	1082	1075	1064	1052	EX8
40	16	17	18	19	20	20	20	21	21	21	21	20	20	EX4
	49	52	55	57	59	60	61	62	62	62	62	61	61	EX5
	118	126	133	138	142	145	147	149	149	149	149	148	146	EX6
	324	348	366	381	392	400	406	409	411	411	409	406	402	EX7
	864	927	977	1015	1045	1067	1082	1091	1095	1095	1091	1084	1073	EX8
35	15	16	18	18	19	20	20	20	21	21	21	20	20	EX4
	45	49	53	55	58	59	60	61	62	62	62	62	61	EX5
	108	118	127	134	139	143	146	148	149	149	149	149	148	EX6
	296	326	349	368	382	393	401	406	409	411	410	409	406	EX7
	789	869	932	981	1019	1048	1069	1083	1092	1095	1095	1090	1082	EX8
30	13	15	16	17	18	19	20	20	20	20	20	20	20	EX4
	38	44	49	52	55	57	59	60	61	61	61	61	61	EX5
	93	107	118	126	133	138	142	145	147	148	148	148	147	EX6
	255	294	325	348	366	380	390	398	403	406	407	406	405	EX7
	680	786	866	928	976	1013	1041	1061	1075	1083	1086	1084	1079	EX8
25	10	13	15	16	17	18	19	19	20	20	20	20	20	EX4
	29	38	44	48	52	54	56	58	59	60	60	60	60	EX5
	71	91	106	117	125	131	136	140	143	144	145	146	145	EX6
	195	251	291	321	344	361	375	385	392	397	399	400	399	EX7
	520	669	775	855	916	964	1000	1027	1046	1058	1065	1067	1065	EX8
20	4	9	12	14	16	17	18	18	19	19	19	20	20	EX4
	13	28	37	43	47	51	53	55	57	58	58	59	59	EX5
	31	68	89	103	114	122	129	133	137	139	141	142	142	EX6
	84	188	244	284	314	337	354	367	377	383	388	390	390	EX7
	225	501	652	758	837	898	944	979	1005	1023	1034	1040	1042	EX8
15		3	9	12	14	15	16	17	18	18	19	19	19	EX4
		10	27	36	42	46	49	52	54	55	56	57	57	EX5
		23	65	86	100	111	119	125	130	133	135	137	137	EX6
		64	178	236	276	305	327	344	357	366	372	376	378	EX7
		172	475	629	735	813	873	917	951	976	992	1003	1008	EX8
10			1	8	11	13	15	16	17	17	18	18	18	EX4
			4	25	34	40	44	47	50	52	53	54	55	EX5
			10	60	82	96	107	115	121	125	128	130	132	EX6
			28	166	225	265	294	315	332	344	352	358	362	EX7
			76	443	600	706	783	841	885	917	940	956	965	EX8

Typical Order Package

- 1) Valve EX4, EX5, EX6, EX7 or EX8 (see page 10),
Plug and cable assembly EX5-N60 Part No. 804 652
- 2) Controller Kit EC3-X32/EC3-X33 (s. page 34 and Overview on page 152)
- 3) optional ECD-002 Display Unit with connection cable (s. page 34)

Application Expansion Valve and Liquid Injection Valve

Condensing Temperature °C	R 124							Valve Type
	Extended capacity kW Evaporating Temperature °C							
	30	25	20	15	10	5	0	
100	7	7	7	6	6	6	5	EX4
	22	21	20	19	18	17	16	EX5
	53	51	49	47	44	42	39	EX6
95	8	8	7	7	7	7	6	EX4
	24	23	23	22	21	20	19	EX5
	57	56	54	52	50	47	45	EX6
90	8	8	8	8	7	7	7	EX4
	25	25	24	24	23	22	21	EX5
	61	59	58	56	54	52	50	EX6
85	9	9	8	8	8	8	7	EX4
	26	26	25	25	24	23	23	EX5
	63	62	61	60	58	56	54	EX6
80	9	9	9	8	8	8	8	EX4
	27	27	26	26	25	25	24	EX5
	64	63	63	62	61	59	57	EX6
75	9	9	9	9	9	8	8	EX4
	27	27	27	26	26	25	25	EX5
	64	64	64	63	62	61	60	EX6
70	9	9	9	9	9	9	8	EX4
	26	26	27	27	26	26	25	EX5
	62	63	64	63	63	62	61	EX6
65	8	8	9	9	9	9	8	EX4
	25	26	26	26	26	26	26	EX5
	60	61	62	63	63	62	62	EX6
60	8	8	8	8	8	8	8	EX4
	23	24	25	26	26	26	26	EX5
	56	58	60	61	62	62	61	EX6

Condensing Temperature °C	R 23												Valve Type
	Extended capacity kW Evaporating Temperature °C												
	-45	-50	-55	-60	-65	-70	-75	-80	-85	-90	-95	-100	
-10	17	18	19	19	19	19	19	19	19	19	19	18	EX4
	53	55	56	57	58	58	58	58	58	57	57	56	EX5
	127	132	135	138	139	140	140	140	139	138	137	135	EX6
-15	16	17	18	18	19	19	19	19	19	19	18	18	EX4
	50	52	54	55	56	57	57	57	57	57	56	55	EX5
	119	125	130	133	135	137	137	137	137	136	135	134	EX6
-20	15	16	17	17	18	18	18	18	18	18	18	18	EX4
	45	48	51	53	54	55	55	55	55	55	55	54	EX5
	109	117	122	127	130	132	133	134	133	133	132	131	EX6
-25	13	14	15	16	17	17	17	18	18	18	18	17	EX4
	40	44	47	49	51	52	53	53	53	53	53	53	EX5
	96	106	113	118	122	125	127	128	129	128	128	127	EX6
-30	11	13	14	15	16	16	16	17	17	17	17	17	EX4
	33	38	42	45	47	49	50	51	51	51	51	51	EX5
	78	92	101	108	114	117	120	122	122	123	123	122	EX6
-35	7	10	12	13	14	15	15	16	16	16	16	16	EX4
	22	30	36	40	43	45	46	47	48	48	48	48	EX5
	53	73	86	96	103	108	111	114	115	116	116	116	EX6
-40		6	9	11	12	13	14	14	15	15	15	15	EX4
		19	28	33	37	40	42	43	44	45	45	45	EX5
		46	67	80	90	96	101	104	106	108	108	108	EX6
-45			5	8	10	11	12	13	13	13	14	14	EX4
			15	25	30	34	37	39	40	41	41	41	EX5
			37	60	73	82	88	93	96	98	99	100	EX6

Typical Order Package

- 1) Valve EX4, EX5, EX6, EX7 or EX8 (see page 10),
Plug and cable assembly EX5-N60 Part No. 804 652
- 2) Controller Kit EC3-X32/EC3-X33 (s. page 34 and Overview on page 152)
- 3) optional ECD-002 Display Unit with connection cable (s. page 34)

Application Expansion Valve and Liquid Injection Valve

Condensing Temperature °C	R 744													Valve Type
	Extended capacity kW Evaporating Temperature °C													
	8	5	0	-5	-10	-15	-20	-25	-30	-35	-40	-45	-50	
10	5	12	18	22	26	29	31	33	34	35	36	37	38	EX4
	15	36	55	68	79	87	94	99	104	108	110	113	114	EX5
	36	86	132	164	189	208	225	238	249	257	264	269	273	EX6
	99	237	362	450	518	572	617	653	683	707	726	740	750	EX7
	-	-	-	-	-	-	-	-	-	-	-	-	-	-
5			12	19	23	27	29	32	33	35	36	37	38	EX4
			37	57	71	81	90	96	102	106	110	113	115	EX5
			89	137	170	195	215	231	244	254	263	269	274	EX6
			244	376	466	535	589	634	670	699	722	739	753	EX7
			-	-	-	-	-	-	-	-	-	-	-	-
0				12	19	24	27	30	32	34	35	36	37	EX4
				38	58	72	83	91	98	103	107	111	113	EX5
				90	139	173	198	218	234	247	257	265	271	EX6
				247	383	475	544	598	642	677	705	727	744	EX7
				659	1023	1267	1452	1598	1715	1809	1883	1942	1987	EX8
-5					12	19	24	27	30	32	34	35	36	EX4
					37	59	73	83	91	98	103	107	110	EX5
					89	140	174	199	219	234	247	257	264	EX6
					245	385	477	547	601	644	678	705	725	EX7
					654	1028	1275	1460	1604	1718	1809	1881	1937	EX8
-10						12	19	24	27	30	32	34	35	EX4
						36	58	72	83	91	97	102	106	EX5
						87	139	173	198	217	233	245	254	EX6
						239	382	475	544	597	639	671	697	EX7
						639	1021	1269	1452	1594	1705	1793	1861	EX8
-15							11	19	23	27	29	31	33	EX4
							35	57	71	82	89	96	100	EX5
							84	137	171	195	214	229	240	EX6
							229	376	468	536	588	628	660	EX7
							613	1003	1250	1431	1570	1677	1761	EX8
-20								11	18	23	26	29	31	EX4
								33	56	70	80	87	93	EX5
								79	133	166	191	209	223	EX6
								216	365	457	523	574	613	EX7
								576	974	1220	1398	1532	1636	EX8
-25									10	18	22	25	28	EX4
									30	53	67	77	85	EX5
									72	128	161	185	202	EX6
									198	350	442	507	556	EX7
									528	935	1179	1353	1483	EX8
-30										9	17	21	24	EX4
										27	51	64	74	EX5
										64	121	154	177	EX6
										175	332	423	486	EX7
										466	887	1129	1298	EX8
-35											7	16	20	EX4
											22	47	61	EX5
											53	113	146	EX6
											145	310	400	EX7
											386	828	1068	EX8
-40												5	14	EX4
												16	43	EX5
												37	103	EX6
												103	284	EX7
												275	759	EX8

Typical Order Package

- 1) Valve EX4, EX5, EX6, EX7 or EX8 (see page 10),
Plug and cable assembly EX5-N60 Part No. 804 652
- 2) Controller Kit EC3-X32/EC3-X33 (s. page 34 and Overview on page 152)
- 3) optional ECD-002 Display Unit with connection cable (s. page 34)

Application Hot Gas Bypass - Nominal Capacities (kW)

Valve Type	Kv, m ³ /h	R 22 / R 407C	R 134a	R 404A / R 507
EX4	0.21	4.9	3.4	4.6
EX5	0.68	16	11	15
EX6	1.57	37	26	35
EX7	5.58	131	92	126
EX8	16.95	399	278	382

The nominal capacity (Qn) is based on the following conditions:

Refrigerant	Evaporating temperature	Condensing temperature	Subcooling
R 407C	+4°C (dew point)	+38°C bubble point / +43°C dew point	1K
R 22, R 134a, R 404A, R 507	+4°C	+38°C	1K

For other operating conditions, an Excel based selection tool can be ordered from the ALCO sales offices or from the internet, or use the quick selection tables below.

Biflow versions are not released for hot gas bypass applications.

EX4..EX8 must be installed with motor downward in hot gas line applications. This insures the valve life expectancy. Install a check valve on main hot gas line just after branch to Control Valve.

Condensing Temperature °C	Extended Capacity kW			Valve type
	R 22 / R 407C	R 134a	R 404A / R 507	
60 bubble point for all refig. (64 dew point for R 407C)	7	4.9	5.8	EX4
	23	16	19	EX5
	54	38	45	EX6
	191	135	161	EX7
	581	411	488	EX8
50 bubble point for all refig. (54 dew point for R 407C)	6.1	4.3	5.5	EX4
	20	14	18	EX5
	46	32	41	EX6
	163	115	147	EX7
	495	348	447	EX8
40 bubble point for all refig. (45 dew point for R 407C)	4.9	3.7	4.9	EX4
	16	12	16	EX5
	38	27	36	EX6
	136	95	130	EX7
	414	289	394	EX8
30 bubble point for all refig. (35 dew point for R 407C)	4.3	2.8	4	EX4
	14	9	13	EX5
	32	22	31	EX6
	112	78	111	EX7
	340	236	336	EX8

Typical Order Package

- 1) Valve EX4, EX5, EX6, EX7 or EX8
Plug and cable assembly EX5-N60 Part No. 804 652
- 2) Driver EXD-U00 Part No. 804 557 and
Terminal Kit K09-U00 Part No. 804 559

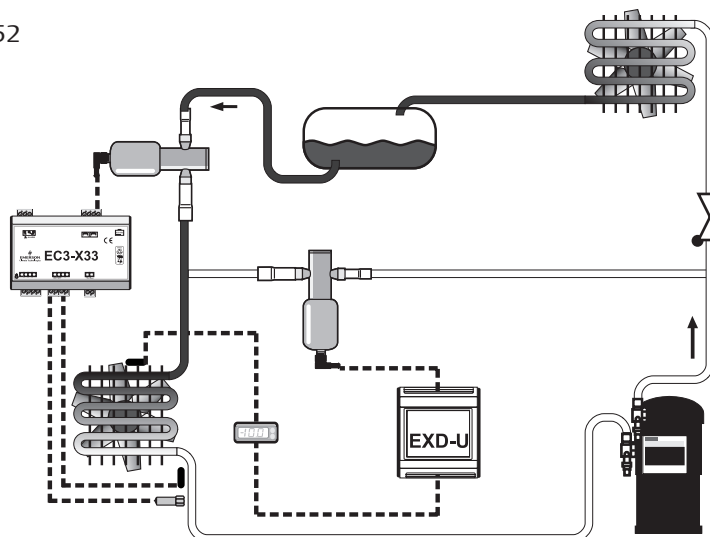

Application Suction Pressure Regulation (evaporating or crankcase pressure) - Nominal Capacities (kW)

Valve Type	Kv, m ³ /h	R 407C	R 22	R 134a	R 404A
EX6	1.57	3.9	4.1	3.1	3.5
EX7	5.58	14	15	11	13
EX8	16.95	42	45	34	38

The nominal capacity (Qn) is based on the following conditions:

Refrigerant	Evaporating temperature	Condensing temperature	Subcooling	Pressure Drop
R 407C	+4°C (dew point)	+38°C bubble point / +43°C dew point	1K	0.15 bar
R 22, R 134a, R 404A	+4°C	+38°C	1K	0.15 bar

For other operating conditions, an Excel based selection tool can be ordered from ALCO or from the internet, or use the quick selection tables below.

For biflow versions attention should be paid to the temperature range TS -40°C bis +80°C!

EX6 .. EX8 must be installed with motor downward in suction line applications. This insures the valve life expectancy.

Multiply above nominal capacities by following factors to obtain capacities at different pressure drops:

ΔP, bar	0.10	0.15	0.20	0.30
Correction factor	0.82	1.00	1.15	1.41

Example:

EX6 provides 3.5 kW at 0.15 bar pressure drop with R404A or 3.5*1.41=4.9 kW at 0.3 bar pressure drop.

Condensing Temperature °C	R 134a Extended capacity kW						Valve type
	Evaporating temperature °C						
	10	5	0	-10	-20		
60	3	2	2	2	1		EX6
	10	9	8	6	4		EX7
	30	27	24	18	13		EX8
50	3	3	2	2	1		EX6
	11	10	9	7	5		EX7
	34	30	27	21	15		EX8
40	3	3	3	2	2		EX6
	12	11	10	8	6		EX7
	38	34	30	23	17		EX8
30	4	3	3	2	2		EX6
	14	12	11	8	6		EX7
	41	37	33	26	19		EX8
20	4	4	3	3	2		EX6
	15	13	12	9	7		EX7
	45	40	36	28	21		EX8

Condensing Temperature °C	R 22 Extended capacity kW							Valve type
	Evaporating temperature °C							
	10	5	0	-10	-20	-30	-40	
60	4	3	3	3	2	2	1	EX6
	13	12	11	9	7	5	4	EX7
	41	37	34	27	22	17	12	EX8
50	4	4	3	3	2	2	1	EX6
	15	13	12	10	8	6	5	EX7
	45	41	37	30	24	19	14	EX8
40	5	4	4	3	2	2	1	EX6
	16	15	13	11	9	7	5	EX7
	49	45	41	33	27	21	15	EX8
30	5	4	4	3	3	2	2	EX6
	17	16	14	12	9	7	5	EX7
	53	48	44	36	29	22	16	EX8
20	5	5	4	4	3	2	2	EX6
	19	17	15	13	10	8	6	EX7
	56	52	47	39	31	24	18	EX8

Typical Order Package

- 1) Valve EX6, EX7 or EX8
Plug and cable assembly EX5-N60 Part No. 804 652
- 2) Controller Kit EXD-U00 Part No. 808 038

Application Suction Pressure Regulation (evaporating or crankcase pressure)

Condensing Temperature °C	R 404A / R 507							Valve type
	Extended capacity kW							
	Evaporating temperature °C							
	10	5	0	-10	-20	-30	-40	
60	3	2	2	2	1	1	1	EX6
	9	8	8	6	4	3	2	EX7
	29	26	23	18	13	10	7	EX8
50	3	3	3	2	2	1	1	EX6
	12	11	9	7	6	4	3	EX7
	36	32	29	23	18	13	9	EX8
40	4	3	3	3	2	1	1	EX6
	14	12	11	9	7	5	4	EX7
	42	38	34	27	21	16	12	EX8
30	4	4	4	3	2	2	1	EX6
	16	14	13	10	8	6	5	EX7
	48	43	39	31	25	19	14	EX8
20	5	4	4	3	3	2	1	EX6
	17	16	14	12	9	7	5	EX7
	53	48	44	35	28	21	16	EX8

Condensing temperature		R 407C					Valve type
Dew point	Bubble point	Extended capacity kW					
°C	°C	Evaporating temperature °C					
		10	5	0	-10	-20	
64	60	3	3	3	2	2	EX6
		12	11	10	8	6	EX7
		36	33	29	23	18	EX8
54	50	4	3	3	2	2	EX6
		14	12	11	9	7	EX7
		41	37	34	27	21	EX8
45	40	4	4	3	3	2	EX6
		15	14	12	10	8	EX7
		46	42	38	30	23	EX8
35	30	5	4	4	3	2	EX6
		17	15	14	11	9	EX7
		51	46	41	33	26	EX8
26	20	5	5	4	3	3	EX6
		18	16	15	12	9	EX7
		55	50	45	36	28	EX8

Typical Order Package

- 1) Valve EX6, EX7 or EX8
Plug and cable assembly EX5-N60 Part No. 804 652
- 2) Controller Kit EXD-U00 Part No. 808 038

Application Condensing Pressure Regulation and Liquid Duty - Nominal Capacities (kW)

Valve Type	Kv, m3/h	R 407C	R 22	R 134a	R 404A
EX5	0.68	18	20	18	13
EX6	1.57	43	46	42	30
EX7	5.58	153	162	151	106
EX8	16.95	463	491	458	323

The nominal capacity (Qn) is based on the following conditions:

Refrigerant	Evaporating temperature	Condensing temperature	Subcooling	Pressure Drop
R 407C	+4°C (dew point)	+38°C bubble point / +43°C dew point	1K	0.35 bar
R 22, R 134a, R 404A	+4°C	+38°C	1K	0.35 bar

Multiply above nominal capacities by following factors to obtain capacities at different pressure drops:

Example:

EX6 provides 30kW at 0.35bar pressure drop with R404A or $30 * 0.76 = 22.8$ kW at 0.2 bar pressure drop.

ΔP, bar	0.15	0.20	0.35
Correction factor	0.65	0.76	1.00

Condensing Temperature °C	R 134a				Extended capacity kW				Valve type
	Evaporating temperature °C								
	10		0		-10		-20		
60	14		13		13		12		EX5
	32		31		29		27		EX6
	115		109		104		98		EX7
	350		332		315		296		EX8
50	16		15		15		14		EX5
	37		36		34		32		EX6
	133		127		121		115		EX7
	405		387		369		350		EX8
40	18		18		17		16		EX5
	42		41		39		37		EX6
	151		145		139		133		EX7
	458		440		422		403		EX8
30	20		20		19		18		EX5
	47		46		44		42		EX6
	168		162		156		150		EX7
	512		493		474		455		EX8
20	22		22		21		20		EX5
	52		51		49		47		EX6
	186		180		173		167		EX7
	564		546		526		507		EX8

Condensing Temperature °C	R 22		Extended capacity kW				Valve type
	Evaporating temperature °C						
	10	0	-10	-20	-30	-40	
60	15	15	15	14	14	13	EX5
	36	35	34	33	32	30	EX6
	128	124	120	116	112	108	EX7
	387	377	365	353	341	328	EX8
50	17	17	16	17	16	15	EX5
	41	40	36	39	36	35	EX6
	144	141	129	137	129	124	EX7
	439	428	391	416	391	377	EX8
40	19	19	19	18	17	17	EX5
	45	44	43	42	41	39	EX6
	161	157	153	149	145	140	EX7
	488	477	465	453	439	426	EX8
30	21	21	20	20	19	19	EX5
	50	49	48	46	45	44	EX6
	177	173	169	165	160	156	EX7
	536	525	513	500	486	472	EX8
20	23	23	22	22	21	21	EX5
	54	53	52	51	49	48	EX6
	192	188	184	180	175	171	EX7
	584	572	560	547	533	519	EX8

Application Condensing Pressure Regulation and Liquid Duty

Condensing Temperature °C	R 404A /R 507		Extended capacity kW				Valve type
	Evaporating temperature °C						
	10	0	-10	-20	-30	-40	
60	8	8	7	6	6	5	EX5
	19	17	16	15	13	12	EX6
	66	62	58	53	48	43	EX7
	202	189	175	160	146	130	EX8
50	11	10	9	9	8	8	EX5
	24	23	22	20	19	17	EX6
	87	82	78	73	67	62	EX7
	264	250	236	220	205	189	EX8
40	13	12	12	11	10	10	EX5
	30	28	27	26	24	23	EX6
	106	101	96	91	85	80	EX7
	321	306	291	276	260	243	EX8
30	15	14	14	13	12	12	EX5
	35	33	32	30	29	27	EX6
	123	119	114	108	103	97	EX7
	375	360	345	329	312	295	EX8
20	17	16	16	15	14	14	EX5
	40	38	37	35	34	32	EX6
	141	136	131	125	120	114	EX7
	427	412	397	380	363	346	EX8

Condensing Temperature		R 407C		Extended capacity kW		Valve type
Dew point °C	Bubble point °C	Evaporating temperature °C				
		10	0	-10	-20	
64	60	14	13	12	12	EX5
		32	30	29	28	EX6
		112	108	103	98	EX7
		340	327	313	298	EX8
54	50	16	15	15	14	EX5
		37	36	35	33	EX6
		132	128	123	118	EX7
		402	388	373	358	EX8
45	40	18	18	17	17	EX5
		43	41	40	38	EX6
		152	147	142	137	EX7
		460	446	431	415	EX8
35	30	21	20	19	19	EX5
		48	47	45	44	EX6
		170	166	160	155	EX7
		517	503	487	471	EX8
26	20	23	22	22	21	EX5
		53	52	50	49	EX6
		189	184	179	173	EX7
		573	558	543	526	EX8

Typical Order Package

- 1) Valve EX6, EX7 or EX8
Plug and cable assembly EX5-N60 Part No. 804 652
- 2) Controller Kit EXD-U00 Part No. 808 038

Application hot gas flow such as heat reclaim application Nominal Capacities (kW)

Valve Type	Kv, m ³ /h	R 22 / R 407C	R 134a	R 404A / R 507	R 410A
EX6	1.57	11	9	10	13
EX7	5.58	39	33	36	47
EX8	16.95	119	101	108	144

The nominal capacity (Qn) is based on the following conditions:

Refrigerant	Evaporating temperature	Condensing temperature	Subcooling	Pressure Drop	Isentropic Efficiency
R 407C	+4°C (dew point)	+38°C bubble point / +43°C dew point	1K	0.5 bar	80%
R 22, R 134a, R 404A, R 507	+4°C	+38°C	1K	0.5 bar	80%

For other conditions see following tables.

Valves must be installed with motor downward in hot gas line applications. This insures the valve life expectancy. Bi-flow versions are not released for hot gas flow applications.

Condensing Temperature °C	Pressure Drop bar	R 134a Extended capacity kW													Valve Type
		Evaporating Temperature °C													
		15	10	5	0	-5	-10	-15	-20	-25	-30	-35	-40	-45	
60	0.1	5	5	4	4	4	4	4	4	4	3	3	3	3	EX6
		16	16	16	15	15	14	14	13	13	12	12	11	10	EX7
		50	49	47	46	44	43	41	40	38	37	35	33	32	EX8
	0.5	10	10	10	9	9	9	8	8	8	7	7	7	6	EX6
		36	35	34	33	32	31	30	29	28	26	25	24	23	EX7
		110	107	104	101	97	94	91	87	84	80	77	74	70	EX8
1.0	14	14	13	13	12	12	12	11	11	10	10	9	9	EX6	
	50	49	47	46	44	43	41	40	38	37	35	34	32	EX7	
	152	148	144	139	135	130	126	121	116	112	107	102	97	EX8	
50	0.1	5	4	4	4	4	4	4	4	4	3	3	3	3	EX6
		16	16	15	15	14	14	14	13	13	12	12	11	11	EX7
		49	48	47	45	44	43	41	40	39	37	36	35	33	EX8
	0.5	10	10	9	9	9	9	8	8	8	8	7	7	7	EX6
		35	35	34	33	32	31	30	29	28	27	26	25	24	EX7
		108	105	102	99	97	94	91	88	85	82	79	76	73	EX8
1.0	14	13	13	13	12	12	12	11	11	10	10	10	9	EX6	
	49	48	46	45	44	43	41	40	39	37	36	34	33	EX7	
	148	145	141	137	133	129	125	121	117	113	109	105	100	EX8	
40	0.1	4	4	4	4	4	4	4	4	4	3	3	3	3	EX6
		16	15	15	14	14	14	13	13	13	12	12	11	11	EX7
		47	46	45	44	43	42	40	39	38	37	36	34	33	EX8
	0.5	10	9	9	9	9	8	8	8	8	7	7	7	7	EX6
		34	33	32	32	31	30	29	28	27	26	26	25	24	EX7
		103	100	98	96	93	91	88	86	83	80	78	75	73	EX8
1.0	13	13	12	12	12	12	11	11	11	10	10	10	9	EX6	
	46	45	44	43	42	41	40	39	38	36	35	34	33	EX7	
	141	138	134	131	128	124	121	117	114	110	107	103	100	EX8	
30	0.1	4	4	4	4	4	4	4	3	3	3	3	3	3	EX6
		15	14	14	14	13	13	13	12	12	12	11	11	11	EX7
		44	43	42	42	41	40	39	38	37	35	34	33	32	EX8
	0.5	9	9	9	8	8	8	8	8	7	7	7	7	6	EX6
		32	31	30	30	29	28	28	27	26	25	25	24	23	EX7
		96	94	92	90	88	86	84	81	79	77	75	72	70	EX8
1.0	12	12	12	11	11	11	11	10	10	10	9	9	9	EX6	
	43	42	41	40	39	38	37	36	35	34	33	32	31	EX7	
	130	128	125	122	119	117	114	111	108	105	102	98	95	EX8	

Typical Order Package

- 1) Valve EX6, EX7 or EX8
Plug and cable assembly EX5-N60 Part No. 804 652
- 2) Controller Kit EXD-U00 Part No. 808 038

Application hot gas flow such as heat reclaim application

Condensing Temperature* °C	Pressure Drop bar	R 22 / R 407C													Valve Type
		Extended capacity kW Evaporating Temperature °C													
		15	10	5	0	-5	-10	-15	-20	-25	-30	-35	-40	-45	
60	0.1	6	5	5	5	5	5	5	5	4	4	4	4	4	EX6
		20	19	19	18	18	17	17	16	16	15	15	14	14	EX7
		59	58	57	55	54	53	51	50	48	47	45	44	42	EX8
	0.5	12	12	12	11	11	11	10	10	10	10	9	9	9	EX6
		43	42	41	40	39	38	37	36	35	34	33	32	31	EX7
		131	129	126	123	119	116	113	110	107	103	100	97	94	EX8
1.0	17	17	16	16	15	15	15	14	14	13	13	13	12	EX6	
	60	59	58	56	55	53	52	51	49	48	46	45	43	EX7	
	183	179	175	171	167	162	158	154	149	145	140	135	131	EX8	
50	0.1	5	5	5	5	5	5	5	5	4	4	4	4	4	EX6
		19	19	18	18	17	17	17	16	16	15	15	14	14	EX7
		58	57	56	54	53	52	51	49	48	47	45	44	42	EX8
	0.5	12	12	11	11	11	11	10	10	10	10	9	9	9	EX6
		42	41	40	40	39	38	37	36	35	34	33	32	31	EX7
		128	126	123	120	117	115	112	109	106	103	100	97	94	EX8
1.0	17	16	16	15	15	15	14	14	14	13	13	13	12	EX6	
	59	57	56	55	54	52	51	50	49	47	46	44	43	EX7	
	178	175	171	167	163	159	155	151	147	143	139	135	131	EX8	
40	0.1	5	5	5	5	5	5	5	4	4	4	4	4	4	EX6
		18	18	18	17	17	17	16	16	16	15	15	14	14	EX7
		56	55	54	52	51	50	49	48	47	45	44	43	42	EX8
	0.5	11	11	11	11	10	10	10	10	9	9	9	9	8	EX6
		40	40	39	38	37	36	35	35	34	33	32	31	30	EX7
		123	120	118	115	113	110	108	105	103	100	97	94	92	EX8
1.0	16	15	15	15	14	14	14	14	13	13	12	12	12	EX6	
	56	55	54	53	52	50	49	48	47	46	44	43	42	EX7	
	170	167	163	160	157	153	149	146	142	139	135	131	127	EX8	
30	0.1	5	5	5	5	4	4	4	4	4	4	4	4	4	EX6
		17	17	17	16	16	16	15	15	15	14	14	14	13	EX7
		53	52	51	50	49	48	46	45	44	43	42	41	40	EX8
	0.5	11	10	10	10	10	10	9	9	9	9	9	8	8	EX6
		38	37	37	36	35	34	34	33	32	31	30	30	29	EX7
		115	113	111	109	107	104	102	100	97	95	93	90	88	EX8
1.0	15	14	14	14	14	13	13	13	12	12	12	12	11	EX6	
	52	51	50	49	48	47	46	45	44	43	42	41	40	EX7	
	159	156	153	150	147	144	141	138	134	131	128	124	121	EX8	

*) Condensing temperatures R 407C:
The relation between bubble points and dew points is as follows:

Bubble point °C	Dew point °C
60	64
50	54
40	45
30	35

Typical Order Package

- 1) Valve EX6, EX7 or EX8
Plug and cable assembly EX5-N60 Part No. 804 652
- 2) Controller Kit EXD-U00 Part No. 808 038

Application hot gas flow such as heat reclaim application

Condensing Temperature °C	Pressure Drop bar	R 404A													Valve Type
		Extended capacity kW													
		Evaporating Temperature °C													
		15	10	5	0	-5	-10	-15	-20	-25	-30	-35	-40	-45	
60	0.1	4	4	4	4	4	3	3	3	3	3	3	2	2	EX6
		15	14	14	13	13	12	11	11	10	10	9	8	8	EX7
		45	43	42	40	38	36	35	33	31	29	27	25	23	EX8
	0.5	9	9	8	8	8	7	7	7	6	6	6	5	5	EX6
		32	31	30	29	28	26	25	24	22	21	20	18	17	EX7
		99	95	92	88	84	80	76	72	68	64	60	56	52	EX8
	1.0	13	12	12	11	11	10	10	9	9	8	8	7	7	EX6
		45	44	42	40	39	37	35	33	31	29	27	26	24	EX7
		137	132	127	122	117	112	106	101	95	89	84	78	72	EX8
50	0.1	5	4	4	4	4	4	4	4	3	3	3	3	3	EX6
		16	16	15	15	14	14	13	13	12	11	11	10	10	EX7
		49	47	46	44	43	41	40	38	36	35	33	31	30	EX8
	0.5	10	10	9	9	9	8	8	8	7	7	7	6	6	EX6
		35	34	33	32	31	30	29	28	26	25	24	23	22	EX7
		107	104	101	98	95	91	88	84	80	77	73	69	65	EX8
	1.0	14	13	13	13	12	12	11	11	10	10	9	9	8	EX6
		49	48	46	45	43	42	40	38	37	35	33	32	30	EX7
		149	145	141	136	131	127	122	117	112	107	102	96	91	EX8
40	0.1	5	4	4	4	4	4	4	4	4	3	3	3	3	EX6
		16	16	16	15	15	14	14	13	13	12	12	11	11	EX7
		50	49	47	46	45	43	42	40	39	37	36	34	33	EX8
	0.5	10	10	10	9	9	9	9	8	8	8	7	7	7	EX6
		36	35	34	33	32	31	30	29	28	27	26	25	24	EX7
		109	107	104	101	98	95	92	89	86	83	79	76	73	EX8
	1.0	14	14	13	13	13	12	12	11	11	11	10	10	9	EX6
		50	49	48	46	45	44	42	41	39	38	36	35	33	EX7
		152	148	144	140	136	132	128	124	119	115	110	105	101	EX8
30	0.1	5	4	4	4	4	4	4	4	4	4	3	3	3	EX6
		16	16	15	15	15	14	14	13	13	13	12	12	11	EX7
		49	48	47	46	45	43	42	41	40	38	37	36	34	EX8
	0.5	10	10	10	9	9	9	9	8	8	8	8	7	7	EX6
		35	35	34	33	32	31	31	30	29	28	27	26	25	EX7
		108	105	103	101	98	95	93	90	87	84	81	78	76	EX8
	1.0	14	13	13	13	13	12	12	12	11	11	10	10	10	EX6
		49	48	47	46	45	43	42	41	40	38	37	36	34	EX7
		149	146	142	139	135	132	128	124	120	117	113	109	104	EX8

Typical Order Package

- 1) Valve EX6, EX7 or EX8
Plug and cable assembly EX5-N60 Part No. 804 652
- 2) Controller Kit EXD-U00 Part No. 808 038

Application hot gas flow such as heat reclaim application

Condensing Temperature °C	Pressure Drop bar	R 410A													Valve Type
		Extended capacity kW													
		Evaporating Temperature °C													
		15	10	5	0	-5	-10	-15	-20	-25	-30	-35	-40	-45	
60	0.1	6	6	6	6	5	5	5	5	5	5	4	4	4	EX6
		21	21	20	20	19	19	18	18	17	16	16	15	15	EX7
		64	63	62	60	58	57	55	53	52	50	48	46	44	EX8
	0.5	13	13	13	12	12	12	11	11	11	10	10	10	9	EX6
		47	46	45	44	43	41	40	39	38	36	35	34	32	EX7
		143	140	137	133	130	126	122	118	115	111	107	103	99	EX8
1.0	19	18	18	17	17	16	16	15	15	14	14	13	13	EX6	
	66	64	63	61	60	58	56	55	53	51	49	47	46	EX7	
	200	196	191	186	182	177	171	166	161	155	150	144	138	EX8	
50	0.1	6	6	6	6	6	6	5	5	5	5	5	5	4	EX6
		22	22	21	21	20	20	19	19	18	18	17	17	16	EX7
		67	66	65	63	62	60	59	57	55	54	52	50	48	EX8
	0.5	14	14	13	13	13	12	12	12	11	11	11	10	10	EX6
		49	48	47	46	45	44	43	42	40	39	38	37	35	EX7
		149	146	143	140	137	133	130	126	123	119	115	111	108	EX8
1.0	19	19	19	18	18	17	17	16	16	15	15	14	14	EX6	
	69	67	66	64	63	61	60	58	57	55	53	51	50	EX7	
	209	204	200	196	191	186	182	177	172	167	161	156	151	EX8	
40	0.1	6	6	6	6	6	6	5	5	5	5	5	5	5	EX6
		22	22	21	21	20	20	19	19	18	18	17	17	16	EX7
		67	66	65	63	62	60	59	58	56	54	53	51	50	EX8
	0.5	14	13	13	13	13	12	12	12	11	11	11	11	10	EX6
		49	48	47	46	45	44	43	42	41	40	39	37	36	EX7
		148	146	143	140	137	134	131	127	124	121	117	114	110	EX8
1.0	19	19	18	18	18	17	17	16	16	16	15	15	14	EX6	
	68	67	66	64	63	61	60	59	57	55	54	52	51	EX7	
	207	203	199	195	191	187	182	178	173	168	164	159	154	EX8	
30	0.1	6	6	6	6	6	5	5	5	5	5	5	5	5	EX6
		21	21	21	20	20	19	19	19	18	18	17	17	16	EX7
		65	64	63	61	60	59	58	56	55	53	52	51	49	EX8
	0.5	13	13	13	13	12	12	12	12	11	11	11	10	10	EX6
		47	46	45	45	44	43	42	41	40	39	38	37	36	EX7
		143	141	138	135	133	130	127	124	121	118	115	112	109	EX8
1.0	18	18	18	17	17	17	16	16	16	15	15	14	14	EX6	
	65	64	63	62	61	60	58	57	56	54	53	51	50	EX7	
	199	195	192	188	185	181	177	173	169	165	160	156	152	EX8	

Typical Order Package

- 1) Valve EX6, EX7 or EX8
Plug and cable assembly EX5-N60 Part No. 804 652
- 2) Controller Kit EXD-U00 Part No. 808 038

Electrical Control Valves Series EX4, EX5, EX6, EX7, EX8

Technical Data

Compatibility *	HCFCs, HFCs, mineral and POE lubricants
MOPD (maximum operating pressure differential)	EX4/EX5/EX6/EX7: 35 bar EX8: 30 bar
Max. working pressure, PS	45 bar
Medium temperature range	
Uni-flow version	TS: -50 ... +100°C
Bi-flow version	TS: -40 ... +80°C
Ambient temperature	-40 ... +55°C
CE marking EX4/EX5 EX6/EX7/EX8	not required required, Cat I, Module A
Salt spray test	non-corrosion stainless steel body
Humidity	5 to 95% R.H.
Connections	ODF stainless steel fittings

Protection accordance to IEC 529, DIN 40050	IP68 with Alco supplied cable connector assembly
Vibration for non-connected and fastened valve	4 g (0 to 1000 Hz, 1 octave /min.)
Shock	20g at 11 ms 80g at 1 ms
Net weight	0.5kg (EX4), 0.52 kg (EX5), 0.60 kg (EX6) 1.1 kg (EX7), 1.5 kg (EX8)
Full travel time	EX4/EX5/EX6: 1.5 seconds EX7: 3.2 seconds, EX8: 5.2 seconds
Seat leakage	Positive shut-off better than solenoid valve
External leakage	≤ 3 gram / year
Package and delivery (individual)	without electrical connector

*) Valves are not released for use with inflammable refrigerants.

Block Diagrams

Superheat Control with EC3-X33 (see page 34)
optional display unit ECD-002

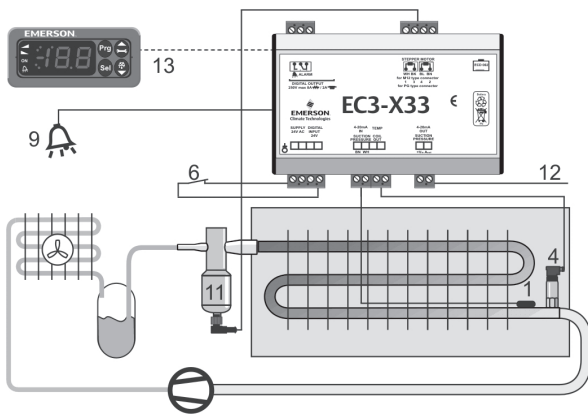

- 1 ECN-N60 sensor
- 4 PT4 pressure transmitter
- 6 Supply / Digital Input
- 9 Alarm out
- 11 EX4 ... EX8 valve
- 12 Suction pressure 4..20mA out
- 13 ECD-002 Display unit

Refrigerant Mass Flow Control with EXD-U (see page 35)

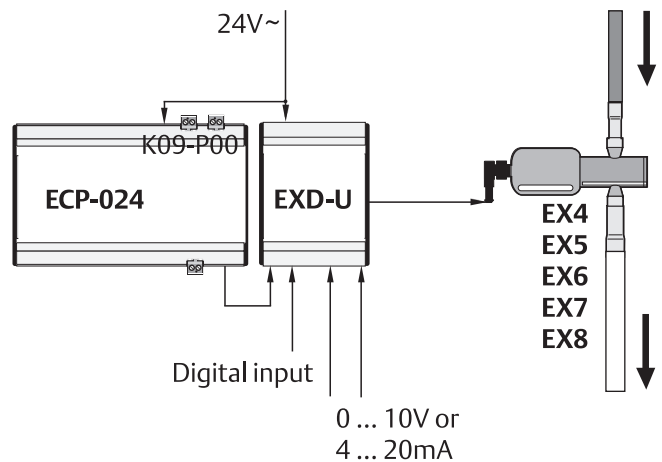

Electronic Controllers and Sensors

Selection Table Electronic Controllers

Description	Network communication			Page
	without	TCP / IP	LON	
Superheat Controllers and Stepper Motor Drivers				
Superheat Controller for Electrical control valves EX4 ... EX8	EC3-X33	EC3-X32		34
Digital Superheat Controller for Electrical control valves EX4 ... EX8	EC3-D73	EC3-D72		34
Universal Stepper Driver Module for Electrical Control Valves EX4 ... EX8	EXD-U00			35
Display Case and Cold Room Controllers for Thermo Expansion Valve applications				
Thermostat, Fan and Defrost control	EC1-233			36
Thermostat Control		EC2-212	EC2-211	38
version for use with a compressor pack system		EC2-292	EC2-291	38
Display Case and Cold Room Controllers for Electrical Control Valves				
Temperature + Superheat Control of EX2 (pressure/temperature input)		EC2-352	EC2-351	38
version for use with a compressor pack system		EC2-372	EC2-371	38
Temperature + Superheat Control of EX2 (temperature/temperature input)		EC2-312	EC2-311	38
version for use with a compressor pack system		EC2-392	EC2-391	38
Thermostat + Superheat Control of EX4 .. EX8 (Stepper Motor)		EC3-332	EC3-331	41
Condensing Unit Controllers				
for 2 single stage compressors and 2 fans, on / off control		EC2-512	-	44
for 2 single stage compressors, variable fan speed control with FSP module		EC2-542	-	44
for 1 Digital Scroll and 1 single stage compressor, fan speed control with FSP		EC2-552	-	44
Rack Controllers and Dual Circuit Controllers				
for 8 single stage compressors or 7 compressors and 1 Digital Scroll		EC3-652	EC3-651	47
for multistage compressors		EC3-672	EC3-671	47
dual circuits with 4 + 3 single stage compressors		EC3-812	EC3-811	47
dual circuits, 4 compressors one of which a Digital Scroll, 3 condenser fans + speed control		EC3-932	EC3-931	47
Condenser Controllers				
for up to 4 fans		EC2-712	EC2-711	44
with fan speed control, 2 digital outputs		EC2-742	EC2-741	44
for up to 6 stages, one with continuous control output 0 ... 10V, heat recovery control		EC3-752	EC3-751	47
Electronic Fan Speed Controllers				
pressure actuated, current range 0,1 ... 4 A	FSY			55
current range 0,3 ... 8 A, 1- or 3-phase versions	FSP/FSE			57
Electronic Smart Starter				
for compressor motors with up to 32 A	ESC			52
Pressure Transmitter				
output signal 4 ... 20 mA	PT4			53
Universal Controllers				
with 2 digital inputs, 3 temperature inputs, 4 relay outputs		EC2-112	EC2-111	38
Monitoring Server				
all hardware and software installed, predefined schematics for all EC controllers		EMS-300		59

Electronic Superheat Controllers and Stepper Motor Drivers

ALCO designed superheat controllers and valve drivers for stepper motor driven control valves for all commercial refrigeration and air-conditioning applications.

EC3-X33 is a universal superheat controller without network communication for air conditioning, refrigeration and industrial applications such as chillers, industrial process cooling, rooftops, heat pumps, package unit, close control, cold room, food process and air driers. The **ECD-002** Display/keypad Unit is necessary for setup but not for operation of the controllers. ECD-002 can be connected or disconnected to EC3-X33 at any time.

In the event of a cooling request and compressor start-up, EC3-X33 needs to be informed. This can be achieved by a digital input. EC3-X33 will start to control the refrigerant mass flow stand-alone by precise positioning of the Control Valve under different operating conditions such as compressor start-up, start of a further compressor, high head pressure, low head pressure, high load, low load and partial load operation. EC3-X33 is capable for diagnostics and alarm. The alarm can be received via relay output as well as optical LED/alarm code on ECD-002.

The **EC3-X32** has a similar function as EC3-X33 but with a TCP/IP Ethernet communication interface enabling the controller to be directly connected to a network or a PC via the standard Ethernet port.

The EC3-X32 controller has embedded WebPages to enable the user to visualise the parameter list with a standard WebBrowser like Internet Explorer®. When connected to a suitable connection, the controller is able to automatically send alarms by email to a PC or mobile phone.

For use with **Copeland's Digital Scroll** technology two other models are available. **EC3-D73** is a stand-alone version for use with the ECD-002 Display / Keypad unit whilst the **EC3-D72** has a TCP/IP Ethernet interface.

A 0-10V demand signal is required from a third party controller to control a tandem system with one fixed and one digital compressor. A patented algorithm synchronises the operation of the PWM digital compressor valve and the EX series electrical control valve.

EXD-U Universal Drivers are stepper motor drivers and enable the operation of ALCO stepper motor driven valves EX4 ... EX8 as Electronic expansion valve, Capacity control by means of hot gas bypass or evaporating pressure regulator, Crankcase pressure regulator, Condenser pressure regulator, Liquid level and Liquid injection.

The universal driver module can be connected to any controller which can provide a 4-20mA or 0-10V analogue signal. The output is the opening/closing of EX4 ... EX8 and consequently the control of the refrigerant liquid or vapour mass flow in accordance with the analogue input.

Display Case and Coldroom Controllers

The **EC1** series is a new series of stand-alone electronic controllers for refrigeration applications. The controllers combine in the small industry standard housing the functionality to control the temperature, fan and defrost in a display case or coldroom.

The compact **EC2** series is available with either TCP/IP or LON communication protocols and covers also applications where the display cases are connected to a multiple compressor application. In this case, the dedicated compressor relay on the controller is no longer required and is available as a spare relay to perhaps switch the display case lighting.

The controllers can therefore be split into two groups; controller is required to switch the compressor directly; integral application and those connected to a multiple compressor (rack) system.

The **EC2-21x**, **EC2-31x** and **EC2-35x** have the dedicated compressor relay

The **EC2-29x**, **EC2-39x** and **EC2-37x** are for use with the rack system.

The **EC2-200** series of controllers are specifically designed for display cases for use **with TXV**. The controller performs the function of thermostat, defrost and fan management and is capable of operating a standalone condensing unit or being incorporated into a distributed system controlled by a rack.

The **EC2-300** series incorporate the functionality of the EC2-200 model but additionally have a superheat algorithm to control the **EX2 control valve**:

EC2-31x / EC2-39x (Temp / Temp): the superheat is controlled using two temperature sensors.

EC2-35x / EC2-37x (Pressure / Temp): the superheat is controlled using a pressure transmitter (PT4 series) in conjunction with a temperature sensor.

Whilst the products were developed for display cases, they may also be applied to control a simple coldroom.

The **EC3 series** utilize in principle the same software technology of the EC2 series but provide additional inputs and outputs to satisfy the requirements of even the most demanding systems. Like the EC2, the EC3 series may be connected together to form larger systems combining the control of multiple compressors and fans. The optional **ECD-001 Display/keypad Unit** is available to display the system temperatures, indicate system status and to modify parameters.

The **EC3-300** series are specifically for use with stepperv valve series (EX4, EX5, EX6, EX7, EX8). In case of power loss the Electrical Control Valve needs to be closed to avoid flooding of the compressor, therefore each valve requires a battery backup. For this reason, the battery together with its automatic charging circuit has been incorporated into the controller housing significantly saving installation time as well as space in the electrical enclosure.



Condensing Units, Rack and Condenser Controllers

Condensing Unit Controllers

The **EC2-500** series of controllers are suitable for controlling the compressors and fans of a condensing unit. Digital inputs are available for individual compressor feedback loops from the safety chain, which typically consists of low and high pressure switches together with motor protection and oil management controls. A common feedback is also available for the fans.

PT4 series pressure transmitters are used to measure the suction and discharge pressures to modulate the compressor and fan capacities.

Three models are available:

EC2-512: to control up to 2 compressors (on/off control) and 2 fans (on/off control)

EC2-542: to control up to 2 compressors; on/off control and a 0...10V output which can be used in conjunction with the **FSP** series of **fan speed power modules** for variable fan speed control.

EC2-552: to control single compressor or tandem compressor condensing units with a Copeland Digital Scroll compressor. It features a 0...10V output to connect to an Alco Controls **FSP fan speed power module** for variable fan speed control. Alternatively this output may be used to control fan motor speed with an inverter or to connect to ECM type fan motors directly.

Rack and Condenser Controllers

The **EC3 series** utilize in principle the same software technology of the EC2 series but provide additional inputs and outputs to satisfy the requirements of even the most demanding systems. Like the EC2, the EC3 series may be connected together to form larger systems combining the control of multiple compressors and fans. Many controllers include 0...10V outputs that may be used in conjunction with frequency inverters and/or the **FSP** series of **fan speed power modules**.

Commonly referred to as "hot application controllers", the **EC3-600, -700, -800 & -900** series controllers are designed for the control of compressors and condensers. Racks with one or two suction groups and up to 8 single stage compressors including a **Copeland Digital Scroll** or 6 multistage compressors can be managed. **EC3-65x** and **EC3-93x** series have been designed to control a **Copeland Digital Scroll** and incorporate a triac to switch the PWM solenoid.

The control of condenser arrays with up to 6 fan stages as well as a combined control of Rack and Condenser is also possible. Refer to the table on page 30 for a complete product listing.

The optional **ECD-000 Display/keypad Unit** is available to display the system temperatures, indicate system status and to modify parameters.

Condenser Controllers

The **EC2-700** series provide an economical solution for condenser control.

Two models are available:

EC2-71x: to control up to 4 fans, on/off. A feedback loop is available for each fan.

EC2-74x: provides a 0...10V output to feed **FSP** series **fan speed power modules**. Several FSP modules may be connected in parallel to speed control all fans simultaneously.

The **EC3 series** provides additional inputs and outputs to satisfy the requirements of even the most demanding systems:

EC3-75x: for condensers with up to 6 stages, one with continuous control output 0 ... 10V, heat recovery control.

The optional **ECD-001 Display/keypad Unit** is available to display the system temperatures, indicate system status and to modify parameters.

The Universal series of Controllers

are useful additions to the series. They are typically used to enable the monitoring of temperatures from integral display cases that do not have communication facilities as well as potentially providing additional input and output functionality to control systems. Example of such applications could be for switching display case lighting or for the monitoring of individual pressure switches on multiple compressor Racks.

Network Communication and System Management

The Alco EC Series of drivers and controllers utilise the very latest in communication technology which is setting new standards in the refrigeration industry. Energy saving algorithms are incorporated into many of the controllers including: Adaptive superheat and thermostat modulation, defrost on demand & suction and discharge setpoint shift.

All **EC2** or **EC3** controllers are available in two communication protocols **TCP/IP Ethernet** and **LON**.

TCP/IP Ethernet:

The controllers are Ethernet based enabling them to be connected directly to any computer via the Ethernet port (RJ45 connector). The controllers act as web server enabling the engineer to pick-up standard configuration pages directly from the controllers without the need of any additional hardware or software. Each controller can be connected to the PC using a crossover cable however, the most convenient way to connect a controller to the PC is to use a router that will automatically assign a TCP/IP address. Either way, the engineer can access the monitoring and parameter configuration pages by entering the TCP/IP number into the address line of an Internet browser such as Mozilla or Microsoft Internet Explorer. User name and password protection is provided to protect the controller from unauthorized access.

- Local alarms via email *
- Remote alarms via email **

* Controller must be connected to the PC

** Router must be connected to an external telephone line and / or the Internet via an Internet Service Provider (ISP).

A new TCP/IP driver has been added to the EMS Monitoring Server enabling the TCP/IP controllers to be incorporated into a system whereby the temperature and status data from multiple controllers can be visualised simultaneously on one screen.

LON Protocol:

An identical range of free-topology LON FTT10 based controllers is available and compliments the TCP/IP controller series. LON is an open system protocol created by Echelon and therefore benefits from not being tied to a restrictive third party protocol.

LON based controllers can be connected to each other to form simple networks for applications requiring master / slave or synchronized defrosting. However, they can also be connected to an **EMS Monitoring Server** to fulfill the most sophisticated system requirements.

The **EMS** acts as an interface from the LON network containing EC2 and EC3 to the outside world. Remote access can be made using standard telephone line; analog or digital ISDN. Alternatively, data can be transmitted via the Internet or a dedicated company Intranet using TCP/IP. Either way, visualization may be made using an industry standard Internet web browser.



Home page of EC2-312 TCP/IP Controller

The **TCP/IP based Controllers** offer a practical solution particularly for smaller installations that require communication for monitoring purposes without the need for customized visualization. For many installations, an additional monitoring server is not required.

Other functions:

- Monitoring of system temperatures and pressures as well as relay status information.
- Read/write of EC2 & EC3 control parameters
- Real time graphical visualization
- Log function of up to one months data directly on the controller
- Log function of data to a PC *
- Storage and retrieval of system parameter.

By transmitting the system status information as temperatures or pressures, used to control the refrigeration circuit in each subsystem, together with other vital system data, the system administrator can potentially identify system failures before they become an expensive stock loss situation. Should a system failure occur, the controllers automatically transfer to an emergency-operating mode whilst sending a system error message to the monitoring server.

The benefit of a **centralized data acquisition system** is that it can dramatically reduce the costs associated with food, which cannot be sold as a result of failing to meet the criteria set by the food hygiene regulations.

The **monitoring server** is typically connected to a analog or digital phone line and can communicate a system alarm to a remote location via fax, email or SMS. In a similar way to the TCP/IP controllers, the engineer can visualize the system without the need of any additional hardware or software. The system can be visualized by entering the TCP/IP address of the EMS Monitoring server into the address line of the Internet web browser. In fact, the advancement of telecommunication systems are such that a maintenance engineer equipped with a laptop computer and mobile telephone can interact with the system from any location.

Superheat Controllers Series EC3-X32 / EC3-X33

for stable superheat control with stepper motor driven electrical control valves Series EX4 - EX8

Digital Superheat Controllers series EC3-D72 / EC3-D73

for stable superheat control with EX4...EX8 electrical control valves and automatic synchronisation of the PWM capacity control valve incorporated into the Copeland Digital Scroll compressor technology

Features

- Limitation of evaporating pressure (MOP)
- Feed-through of 4 ... 20mA signal of evaporating pressure transmitter to operate third party controllers with a common pressure transmitter
- Intelligent alarm management, superheat alarm
- Monitoring of sensors and sensor wiring, detection of sensor and wiring failures
- Integral rechargeable battery to close Electrical Control Valve in case of power loss
- Electrical connection via plug-in type screw terminals
- Aluminum housing for DIN rail mounting



EC3-X33 with ECD-002

Additional features EC3-X32 and EC3-D72 with TCP/IP

- WebServer functionality allows monitoring and configuration of controllers through a standard WebBrowser (e.g. Internet Explorer®)
- Internal data logging and alarm messaging by email
- Multiple language support (www.emersonclimate.eu)
- Freeze protection
- Low and high superheat alarm
- Low pressure switch function/Alarm

ECD-002 Display Unit

- Front panel mounted interface for parameter and status read-out and controller setup via keypad
- Indicator LEDs for valve opening/closing, external ON and alarm

Selection Table

Description	TCP/IP			Stand alone		
	Type	Part No. single unit	Part No. Kit*	Type	Part No. single unit	Part No. Kit*
Superheat Controller	EC3-X32	807 782	808 037	EC3-X33	807 783	808 036
Terminal Kit for EC3-X32/-X33	K03-X32	807 644		K03-X33	807 645	
Digital Superheat Controller	EC3-D72	807 805	808 042	EC3-D73	807 804	808 041
Terminal Kit for EC3-D72/-D73	K03-331	807 648		K03-331	807 648	

*) Kits contain terminal kit, pressure transmitter PT4-07M with cable assembly, NTC sensor 6m, transformer 60VA (see page 152)

Accessories

Description	Type	Part No.	Note
Display	ECD-002	807 657	
Connection cable EC3 to ECD	ECC-N10	807 860	1m cable length
	ECC-N30	807 861	3m cable length
	ECC-N50	807 862	5m cable length
Pressure Transmitter	PT4-07M	802 332	for R134a, R22, R404A, R407C, R507C, R124
	PT4-18M	802 333	for R 410A only
	PT4-30M	802 334	for R744
Cable Assembly for PT4	PT4-M60	804 805	other cable lengths see page 53
Temperature Sensor NTC	ECN-N30	804 496	3m cable length
	ECN-N60	804 497	6m cable length
	ECN-N99	804 499	12m cable length
Transformer	25VA	ECT-323	804 424 for EX4 to EX7
	60VA	ECT-623	804 421 for EX8



PT4

PT4-Mxx



ECT-323

Typical Ordering package

System with 100 kW cooling capacity and refrigerant R22 requires the following parts:

EX6	Electronic Expansion Valve	ECN-N60	NTC Temperature Sensor
EX5-N60	Electrical Cable and Plug assembly	PT4-07M	Pressure Transmitter
EC3-X33	Superheat Controller Stand-alone	PT4-M60	Cable assembly PT4 6.0m
K03-X33	Terminal Kit for EC3-X33	ECD-002	Display (optional)
ECT-323	Transformer 25VA	ECC-N30	Connection cable EC3 to ECD (opt.)

Universal Driver Modules Series EXD-U00

for the operation of ALCO stepper motor valves EX4 / EX5 / EX6 / EX7 / EX8 as

- Solenoid Valve
- Electrical Expansion Valve
- Hot Gas Bypass or Evaporating Pressure Regulator as capacity control
- Crankcase Pressure Regulator
- Heat Reclaim Regulator
- Liquid Level Control

Features

- Plug and play, no parameter setting
- Valve opening proportional to 4-20mA or 0-10V analogue input signal
- Digital input can be used to force valve closing
- Dip-switches for selection of Electrical Control Valves, analogue input and start mode
- Aluminium housing for DIN Rail mounting
- Easy wiring
- Fully tested and ready for operation
- CE-marking for electromagnetic compatibility

Options

- Uninterruptible Power Supply ECP-024 to automatically close valve after power down



EXD-U00

Selection Table

Description	Type	Part No. single unit	Part No. Kit*
Universal Driver Module	EXD-U00	804 557	808 038
Electrical Terminal Kit	K09-U00	804 559	

*) Controller Kit contains terminal kit

Accessories

Description	Type	Part No.	Note
Uninterruptible Power Supply	ECP-024	804 558	for up to 2 driver modules
Electrical Terminal Kit	K09-P00	804 560	for ECP-024
Transformer 230V / 24V AC	25VA	ECT-323	804 424
	60VA	ECT-623	804 421



ECT-323

Capacity Data

see Electrical Control Valve EX4 ... EX8 data.

For function as:

- Expansion Valve - Superheat Control see page 11
- Capacity Control by means of Hot Gas Bypass see page 19
- Evaporating Pressure Regulator or Crankcase Pressure Regulator see page 20
- Condensing Pressure Regulation and Liquid Duty see page 22
- Application hot gas flow such as heat reclaim application see page 24

See datasheet A3.5.048 for detailed application drawings and technical data. For other than the specified operating conditions an Excel based **Selection Tool** can be downloaded from www.emersonclimate.eu.



ECP-024

Display Case and Coldroom Controllers Series EC1

without network communication

Features

- Thermostat function for Thermo® Expansion Valve applications
- Fan control function
- Defrost control with electrical or off-cycle defrost
- Integral mains transformer: 230V
- Air temperature control using standard ECN-S series NTC sensors
- Defrost control with dedicated termination sensor ECN-S series
- Electrical connection screw terminals with cable protection
- 3 digit LED display with decimal point
- Optional programming key for quick transfer of control parameters into multiple controllers
- Indicator LEDs for compressor, fan & heater
- Display and parameter setting selectable °C / °F
- Standard 71 x 29 mm cut-out dimensions
- IP 65 protection class when mounted in front panel
- CE approval



EC1

Selection Table

Description	Type	Part No.
Display Case and Coldroom Control with Thermo® Expansion Valves, three relays for temperature, fan and defrost control , electrical or off-cycle defrost	EC1-233	803 488

Accessories

Description	Cable length	Type	Part No.
NTC Sensors (Air type) (10kΩ at 25°C)	1.5m	ECN-S15	804 304
	3m	ECN-S30	804 305
	6m	ECN-S60	804 284
EC1 Programming Key		EC1-PK1	804 390



EC1-PK1

Technical Data

Supply Voltage	230VAC ± 10% 50/60 Hz	Temperature	
Power Consumption	3VA max.	Storage	-20 ... +65°C
Display	3 digits red LED	Operating	0 ... +60°C
Display Range	-45.5 to +110 switchable between °C & °F 4 indicator LEDs	Humidity	0 ... 80% r.h. non condensing
Screw connector size	Wire size 0.14 ... 1.5mm ²	Protection class	IP65 (front protection with gasket)
Communication	None	Inputs	
Weight	~ 150g	NTC temperature	-50...50°C
Mounting	Panel mount (71 x 29mm cutout)	Output relays	
		Resistive (AC1) 250V	8A
		Inductive (AC15) 250V	2A

Block diagram

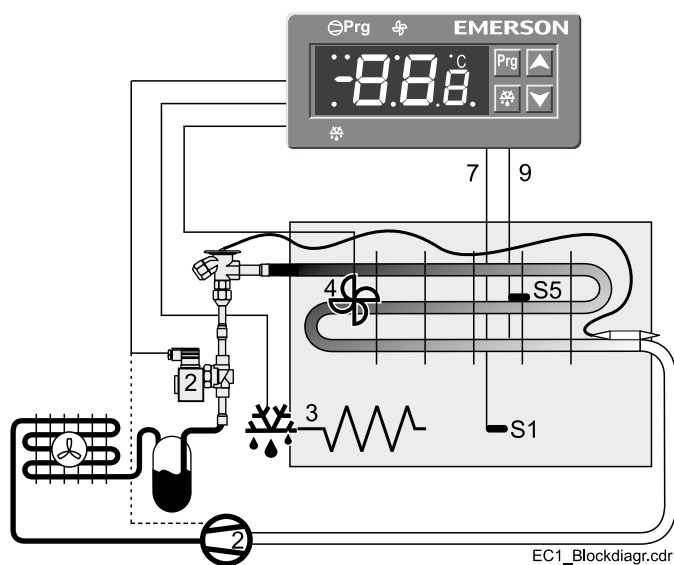

Inputs

7 = Air in sensor ECN-Sxx (S1)
9 = Defrost sensor ECN-Sxx (S5)

Outputs

2 = Compressor
3 = Defrost heater
4 = Fan

Display Case and Universal Controllers Series EC2

with Web Server functionality and TCP/IP Protocol or with LON Protocol (FTT-10)

Features of EC2-3 models:

- Superheat control for Pulse Width Modulated Valves (e.g. EX2-Series) see Selection Table
- Self-adapting controller, no user setup necessary
- Limitation of evaporating temperature (MOP)

Features of all models:

- Air temperature control
- Defrost timer for natural, electric or hot-gas defrost with fan control
- Integrated timer and alarm functions
- All parameters and functions are programmable:
 - via standard web browser (EC2-xx2 models)
 - via LON communication (EC2-xx1 models)
 - with integral keypad
 - with optional infrared remote control
- Password protection to eliminate unauthorised use
- Multiple language support (www.emersonclimate.eu)
- Standard 29 x 71 mm cutout dimensions
- 2 ½ digit display in °C or °F
- CE approved

Communication LON (see page 33)

- Echelon® LON FTT-10 interface based on the Lonworks® standard for monitoring and configuration through a supervisory system such as the EMS Monitoring Server

Communication TCP/IP Ethernet

- Web Server function provides monitoring and configuration through a standard web browser. Ethernet interface, as used in most office PCs.
- Graphical visualisation via built-in webpages
- Fixed or dynamic TCP/IP address with username and password
- Alarms via e-mail
- Up to 30 days datalog



EC2 Controller

Options

- Standard screw terminal kit K02-000 available for all models. OEM crimp versions available upon request.
- Ethernet cable ECX-N60 for EC2-xx2
- NTC temperature sensors
- Transformers for 230VAC mains
- ALCO EC2-IRx Series Infrared Remote Control for easy parameter setting and programming

Example for Webpage monitoring



Selection Table

Functional Overview	TCP/IP			LON		
	Type	Part No. single unit	Part No. Kit*	Type	Part No. single unit	Part No. Kit*

Display Case and Cold Room Controllers

Temperature and Superheat Control of EX2 (Press. / Temp. input) version for use with a compressor pack system	EC2-352	807 772	808 009	EC2-351	807 771	808 008
	EC2-372	807 688	808 011	EC2-371	807 689	808 010

*) Kit contains terminal kit, pressure transmitter PT4-07M with cable assembly, transformer 25VA, 4 NTC sensors 6m fin, pipe and air version (EC2-35x only)

Temperature and Superheat Control of EX2 (Temp. / Temp. input) version for use with a compressor pack system	EC2-312	807 682	808 005	EC2-311	807 681	808 004
	EC2-392	807 692	808 007	EC2-391	807 691	808 006

*) Kit contains terminal kit, transformer 25VA, 5 NTC sensors 6m fin, pipe and air version (EC2-31x only), see also page 152.

Thermostat control, for Thermo-Expansion valve version for use with a compressor pack system	EC2-212	807 482	808 001	EC2-211	807 481	808 000
	EC2-292	807 672	808 003	EC2-291	807 671	808 002

*) Kit contains terminal kit, transformer 25VA, 3 NTC sensors 6m fin, pipe (EC2-29x only) and air version (EC2-21x only), see also page 152.

Universal Controllers with 2 digital inputs, 3 temperature inputs, 4 relay outputs	EC2-112	807 472		EC2-111	807 471	
--	----------------	----------------	--	----------------	----------------	--

Accessories	Type	Part No.
Terminal kits, cables		
Terminal kit for EC2-31x, -35x, -37x, -39x	K02-000	800 050
Terminal kit for EC2-11x, -21x, -29x	K02-211	807 647
Ethernet Cable RJ45/4-pin-conn. 6m cable length	ECX-N60	804 422



K02-000

Sensors			
Air-Sensors, single insulated (10 kΩ at 25°C) for EC2-21x, -31x, -35x	1,5m cable length	ECN-S15	804 304
	3m cable length	ECN-S30	804 305
	6m cable length	ECN-S60	804 284
Pipe-Sensors * (10 kΩ at 25°C) Air sensors for EC2-29x, EC2-3xx	3m cable length	ECN-P30	804 280
	6m cable length	ECN-P60	804 281
	8m cable length	ECN-P80	804 282
Defrost sensor (10 kΩ at 25°C) (including fin clip)	6m cable length	ECN-F60	804 283
Pressure transmitter	-0.8...7 bar	PT4-07M	802 332
	0 ... 18 bar	PT4-18M	802 333
Cable plug assembly for PT4	1.5m cable length	PT4-M15	804 803
	3m cable length	PT4-M30	804 804
	6m cable length	PT4-M60	804 805



ECT-323



EC2-IRE

*) it is possible to use ECN-Nxx series as alternative to ECN-Pxx series (see page 34)

Transformer	230VAC Input, 24V output, 25VA, DIN rail	ECT-323	804 424
	230/110VAC Input, 12/24V output, 20VA	ECT-523	804 332

Infrared Remote Control	Language: English	EC2-IRE	804 345
	German	EC2-IRD	804 346
	French	EC2-IRF	804 347
	Spanish	EC2-IRS	804 348
	Italian	EC2-IRI	804 349

Technical Data

Supply voltage	24V AC ±10% 50/60 Hz class II only	Temperature storage	-10 ... +70°C
Power consumption	20VA incl. EX2 valve (EC2-3xx) 3VA (EC2-11x, -21x, -29x)	operation	0 ... +50°C (housing)
Inputs	up to 5 Temperature sensors: Refrigerant inlet (saturated temp.) Refrigerant outlet (suction temp.) Air into / Air out of evaporator Defrost termination	operation	-50 ... +50°C (NTC sensor)
		Display	2½ digits red LED Automatic decimal point between -19.9 & +19.9 Switchable between °C & °F
		Indicator LEDs	Compressor, defrost, fan, alarm, service LED
		Protection	IP 65 (front protection with gasket)
Output contact rating cos φ = 0.5:	SPDT & SPST relays, 250V max / 8A resistive load EC2-3xx 6A resistive load EC2-2xx 2A inductive load all EC2	Sensor type	NTC 10KΩ @ 25°C Order codes see above
(Voltage free contacts)	(defrost, compressor, fan)	Weight	~ 150g
Triac output to EX2	24VAC, 1 A max.		
Communication	LON: FTT10 , TCP/IP: Ethernet		

Typical Order Package for a display case

Case Controller	EC2-312	807 682
Terminal Kit	K02-000	800 050
Electrical Control Valve	EX2-M00	801 091
Orifice size 3	EXO-003	801 088
Coil 24VAC / 2W	ASC 24V	801 062
Cable Assembly for ASC	ASC-N15	804 570
2 pipe sensors	ECN-P60	804 281
2 air sensors	ECN-S30	804 305
Defrost sensor	ECN-F60	804 283
Transformer 25VA	ECT-323	804 424
Ethernet Cable 6m	ECX-N60	804 422

Block Diagrams

EC2-35x / -37x Case Controller (EX2, Press/Temp)

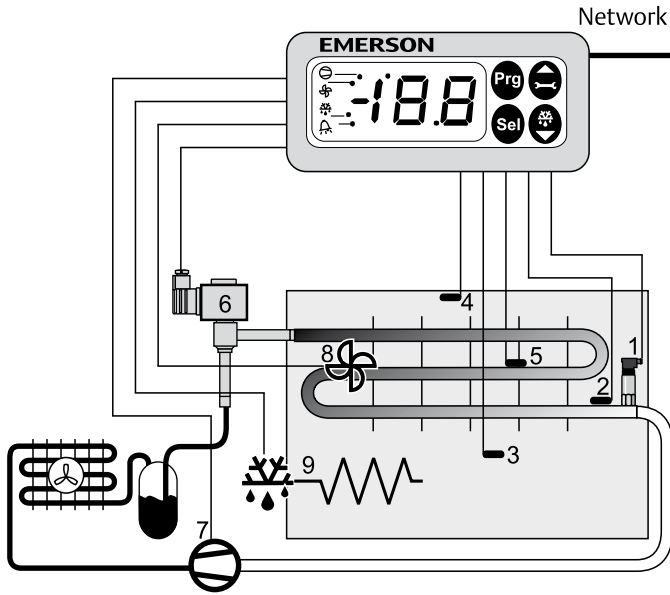

Inputs

- 1 = Suction pressure
- 2 = Coil out temperature
- 3 = Air in temperature
- 4 = Air out temperature
- 5 = Defrost temperature

Outputs

- 6 = EX2 Expansion valve
- 7 = Compressor (EC2-35x only)
- 8 = Fan
- 9 = Defrost heater
- 10 = spare relay (EC2-37x only)

EC2-31x / -39x Case Controller (EX2, Temp/Temp)

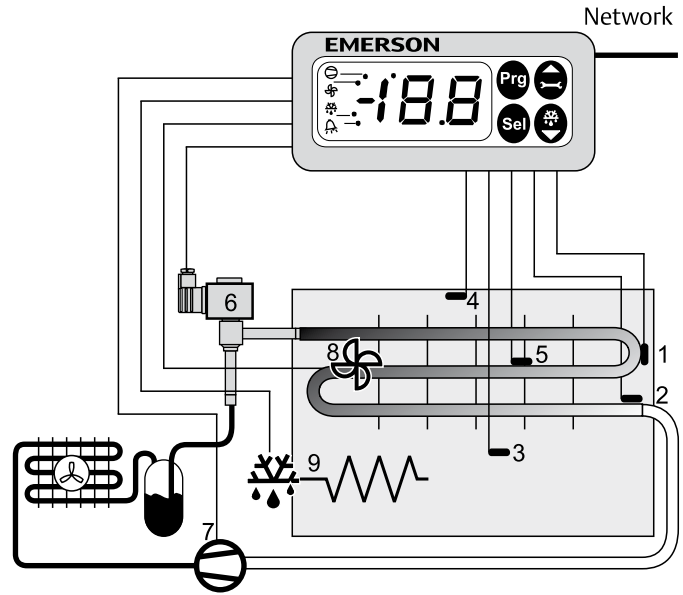

Inputs

- 1 = Coil in temperature
- 2 = Coil out temperature
- 3 = Air in temperature
- 4 = Air out temperature
- 5 = Defrost temperature

Outputs

- 6 = EX2 Expansion valve
- 7 = Compressor (EC2-31x only)
- 8 = Fan
- 9 = Defrost heater
- 10 = spare relay (EC2-39x only)

EC2-21x / -29x Case Controller (TXV)

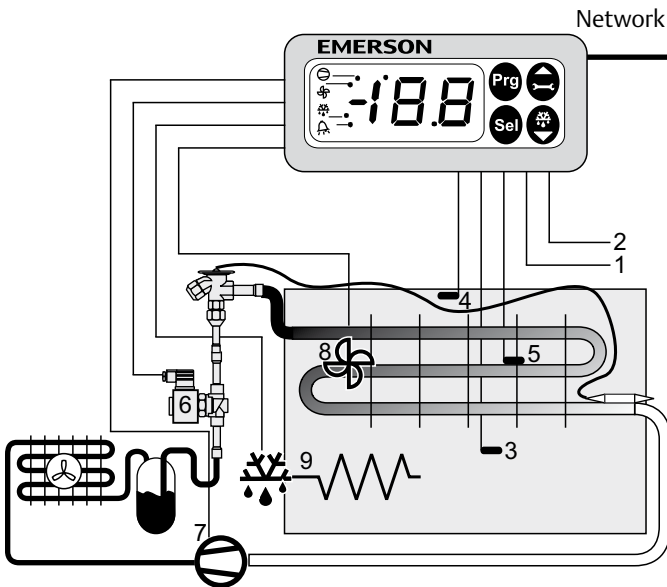

Inputs

- 1 = Digital Input
- 2 = Digital Input
- 3 = Air in temperature
- 4 = Air out temperature
- 5 = Defrost temperature

Outputs

- 6 = Solenoid valve
- 7 = Compressor (EC2-21x only)
- 8 = Fan
- 9 = Defrost heater
- 10 = spare relay (EC2-29x only)

EC2-11x Universal I/O Controller

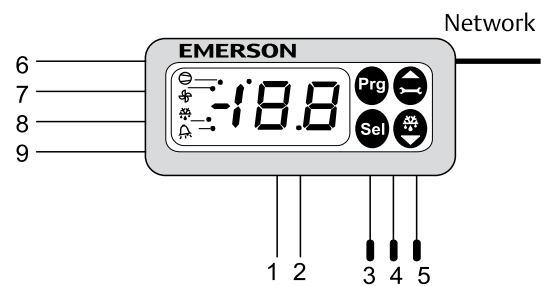

Inputs

- 1 = Digital Input
- 2 = Digital Input
- 3 = Temperature input
- 4 = Temperature input
- 5 = Temperature input

Outputs

- 6 = Digital output
- 7 = Digital output
- 8 = Digital output
- 9 = Digital output

Coldroom Controller Series EC3

Temperature and Superheat Control of EX4 .. EX8 (Stepper Motor)

Features

- Superheat control with self-adapting algorithm for Stepper Motor driven ECVs (EX4 ... EX8)
- Thermostat, fan & defrost control
- Limitation of evaporating temperature (MOP)
- Analog inputs: 3 NTC temperature sensors
- with integral backup battery to close Control Valve in case of power loss
- Analog input for suction pressure measurement using Alco PT4 Series pressure transmitters
- Digital inputs for compressor safety and coldroom door contact
- Relay outputs for compressor, defrost and alarm plus programmable relay
- All parameters and functions are programmable:
 - via TCP/IP Ethernet controller (EC3-xx2)
 - via LON communication (EC3-xx1 models)
 - with keypad of optional display unit ECD-001
 - with optional infrared remote control EC2-IRx
- Electrical connections via plug-in type screw terminals
- Lightweight aluminum enclosure for DIN rail mounting
- Multiple language support (see www.emersonclimate.eu)
- CE approved

Communication TCP/IP Ethernet

detailed information on page 33

Communication LON

detailed information on page 33

Options

- Front mounted ECD-001 Display Unit for temperature and output status indication
- Alco Controls EC2-IRx Infrared Remote Control for easy parameter setting and programming. Available in English, German, French, Italian & Spanish languages
- NTC temperature sensors
- AMS Series Monitoring Server for remote visualisation and programming

Typical Order Package

Coldroom Controller	EC3-332	807 632
Terminal Kit	K03-331	807 648
Display Unit (optional)	ECD-001	807 641
Connection cable EC3 to ECD 1m	ECC-N10	807 860
Transformer 20 VA	ECC-323	804 424
Sensors: depending on application	(see page 42)	
Ethernet Cable 5m	ECC-N50	807 862



EC3-332

ECD-001

Features of ECD-001 Display Unit

- Connection to EC3 Series via a RJ45 Western Digital plug. No further power cables required
- 2 ½ digit display
- Indicator LEDs for compressor, fan, heater and alarm
- 4 keys allow parameter modification if necessary
- Easy mounting in panels with 71 x 29 mm cutout
- IP65 if mounted in front panel

Selection table

Description	TCP/IP			LON		
	Type	Part No. single unit	Part No. Kit*	Type	Part No. single unit	Part No. Kit*
Coldroom Controller ECV Stepper Motor Drive	EC3-332	807 632	808 013	EC3-331	807 631	808 012

*) Kit contains terminal kit, pressure transmitter PT4-07M with cable assembly, transformer 25VA, NTC sensors 6m fin, pipe and single insulated version (see also page 152)

Accessories

Terminal Kits

Description	Type	Part No.
Schraubklemmsatz für EC3-33x	K03-331	807 648



K03-331

ECD Series Display Units

Display for EC3-33x	ECD-001	807 641
Connection cable EC3 to ECD 1m (3m/5m see page 51)	ECC-N10	807 860

NTC Sensors (Air type) (10 kΩ at 25°C)	1,5m cable length	ECN-S15	804 304	
	3m cable length	ECN-S30	804 305	
	6m cable length	ECN-S60	804 284	
NTC Sensors (Pipe type) (10 kΩ at 25°C)	3m cable length	ECN-P30	804 280	
	6m cable length	ECN-P60	804 281	
	8m cable length	ECN-P80	804 282	
NTC Sensors (Fin type) (10 kΩ at 25°C)	6m cable length	ECN-F60	804 283	
Pressure transmitter	-0.8...7 bar	PT4-07M	802 332	
Cable plug assembly (s. page 53)	1.5m length	PT4-M15	804 803	
Transformer for DIN rail mounting, Class II	230VAC Input / 24V output	25VA	ECT-323	804 424
		60VA	ECT-623 *	804 421



PT4

PT4-Mxx



ECT-623

*) EX8 only

Infra Red Remote Control

Language:	English	EC2-IRE	804 345
	German	EC2-IRD	804 346
	French	EC2-IRF	804 347
	Spanish	EC2-IRS	804 348
	Italian	EC2-IRI	804 349



EC2-IRE

Technical Data

Controller EC3-33x

Supply voltage	24 VAC ±10%, 50/60 Hz Class II only
Power consumption	25VA max. for EX4 .. EX7 28VA max. for EX8
Plug-in connector size	Removable screw version wire size 0.14 ... 1.5 mm ²
Communication interface	LON FTT10 (EC3-331) TCP/IP Ethernet with Webserver (EC3-332)
Temperature storage	-20 ... +65°C
Temperature operating	0 ... +60°C
Humidity	0 ... 80% r.h. non condensing
Protection class	IP 20
Weight	~ 800 g
Mounting	DIN rail mounted

Display Unit ECD-001

Supply voltage	via ECC-N10 from EC3 controller
LED indicators	Compressor, fan, defrost, alarm outputs LON service pin & IR controller status
Display LED	Numeric segmental display, red, 2½ digits with automatic dec. point betw. ±19.9 switchable between °C and °F
Operating Keys	4 operating keys: Programming, select service/up, defrost/down
Connecting lead	1m (ECC-N10) with RJ45 connectors
Temperature storage	-20 ... +65°C
Temperature operating	0 ... +60°C
Humidity	0 ... 80% r.h. non condensing
Protection class	IP 65 (front panel with gasket)
Weight	~ 52 g
Mounting	Panel door (71 x 29mm cutout)

Block Diagram

EC3-33x Coldroom Controller for stepper motor driven ECV

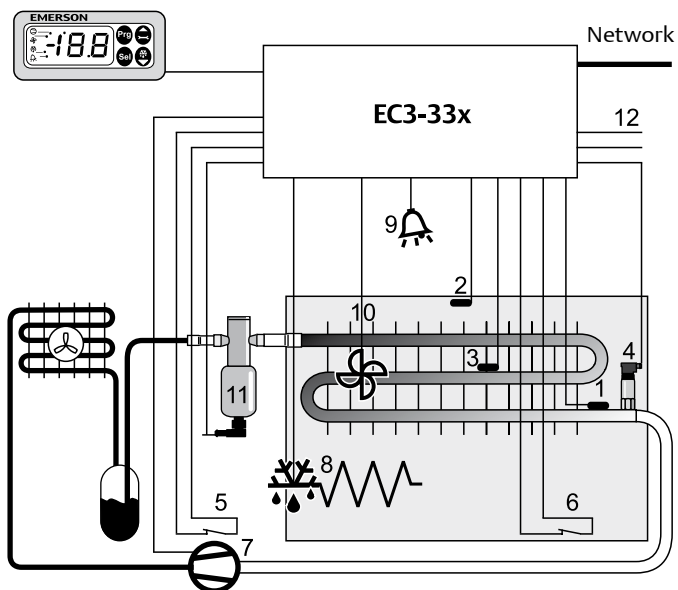

Inputs

- 1 = Coil out temperature
- 2 = Air temperature
- 3 = Defrost temperature
- 4 = Suction pressure
- 5 = Compressor safety
- 6 = Door contact

Outputs

- 7 = Compressor
- 8 = Defrost heater
- 9 = Alarm
- 10 = Fan
- 11 = Stepper motor ECV
- 12 = Output signal (4...20 mA)

Condenser- and Condensing Unit Controllers Series EC2

with Webserver Function and TCP/IP or with LON FTT-10 Interface

Common Features

- Maintenance and alarm management
- Sensor failure handling
- Inputs for common low and common high pressure alarms
- Configuration data stored in non-volatile memory
- Electrical connection via plug-in type screw terminals
- with Webserver Function and TCP/IP or with LON FTT-10 Interface (see page 33)
- Operation and commissioning via local or remote PC
- CE approved

Condenser Controllers

- Compact controller to control condensing pressure by modulation of fan capacity

Condensing Unit Controllers

- To control a combination of compressors and condenser fans based on suction and condensing pressure respectively
- Control of Copeland Digital Scroll Compressors

Communication LON

- Echelon® LON FTT10 interface based on the LonWorks® standard for monitoring and configuration through a supervisory system such as the EMS Monitoring Server

Communication TCP/IP Ethernet

- Web Server Function provides monitoring and configuration through a standard web browser. Ethernet interface, as used in most office PCs
- Graphical visualisation via built-in webpages
- Fixed or dynamic TCP/IP address with username and password
- Alarms via e-mail
- Up to 30 days datalog
- Multiple language support (see www.emersonclimate.eu)



**EC2
Controller**



**EC2-IRE
Remote Control**

Selection table

Description	TCP/IP			LON		
	Type	Part No. single unit	Part No. Kit*	Type	Part No. single unit	Part No. Kit*

Condenser Controllers

Condenser Controller for up to 4 fans	EC2-712	807 752	808 021	EC2-711	807 751	808 020
Condenser Controller with fan speed control	EC2-742	807 762	808 023	EC2-741	807 761	808 022

*) EC2-7xx Kits contain terminal kit, pressure transmitter PT4-30M with cable assembly, transformer 25VA (see also page 152).

Condensing Unit Controllers

Condensing Unit Controller for 2 compressors, 2 fans, with on/off control	EC2-512	807 732	808 015	-	-	-
Condensing Unit Controller for 2 compressors, fan speed control with FSP module	EC2-542	807 735	808 017	-	-	-
Condensing Unit Controller for 1 Digital Scroll Compressor and 1 single stage compressor, variable fan speed control with FSP module	EC2-552	807 738	808 019	-	-	-

*) EC2-5xx Kits contains terminal kit, pressure transmitters PT4-07M and PT4-30M with cable assemblies, transformer 25VA (see also page 152).

Accessories

Description	Type	Part No.
Terminal kits for EC2-51x, -71x series	K02-211	807 647
Terminal kits for EC2-54x, -55x, -74x series	K02-540	800 080



K02-211

NTC Sensor ECN single insulated for ambient temperature sensing -50 ... +50°C (10 kΩ at 25°C)	1,5m	ECN-S15	804 304
	3m	ECN-S30	804 305
	6m	ECN-S60	804 284

Pressure transmitter PT4 for suction and condensing pressure sensing (details see page 53)			
-0.8 ... 7 bar, 4 ... 20 mA		PT4-07M	802 332
0 ... 18 bar, 4 ... 20 mA		PT4-18M	802 333
0 ... 30 bar, 4 ... 20 mA		PT4-30M	802 334
Cable assembly (3,0/6,0m see page 53)	1,5m	PT4-M15	804 803



PT4

PT4-Mxx

Transformer	230VAC Input, 24V output, 25VA, DIN rail	ECT-323	804 424
	230/110VAC Input, 12/24V output, 20VA	ECT-523	804 332



ECT-323

Infrared Remote Control	Language		
	English	EC2-IRE	804 345
German	EC2-IRD	804 346	
French	EC2-IRF	804 347	
Spanish	EC2-IRS	804 348	
Italian	EC2-IRI	804 349	



EC2-IRE

Block Diagrams

EC2-74x Condenser Controller with fan speed control

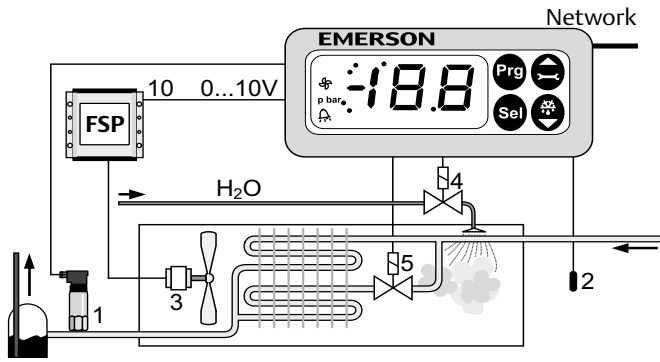

Inputs

- 1 = Condenser pressure
- 2 = Ambient temperature

Outputs

- 3 = Speed controlled fan
- 4 = Sprinkler
- 5 = Solenoid valve at 2 stage condenser coil

EC2-71x Condenser Controller for up to 4 fans

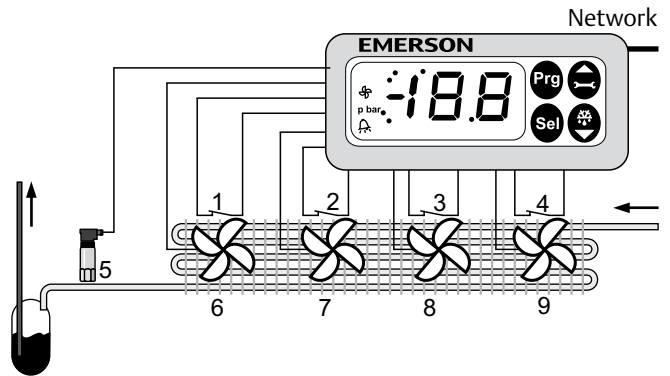

Inputs

- 1 = Safety switch fan 1
- 2 = Safety switch fan 2
- 3 = Safety switch fan 3
- 4 = Safety switch fan 4
- 5 = Condenser pressure

Outputs

- 6 = Fan 1
- 7 = Fan 2
- 8 = Fan 3
- 9 = Fan 4

EC2-542 Condensing Unit Controller with fan speed control

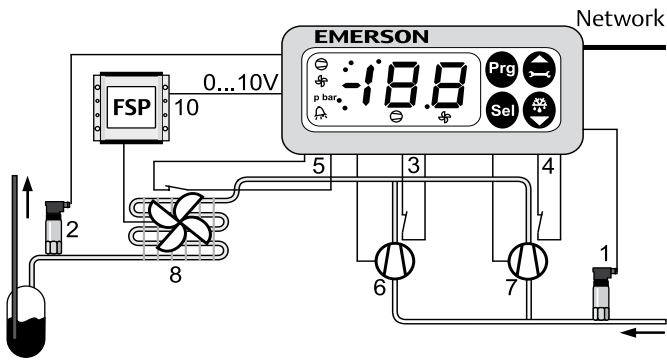

Inputs

- 1 = Suction pressure
- 2 = Condenser pressure
- 3 = Safety switch comp 1
- 4 = Safety switch comp 2
- 5 = Safety switch fan

Outputs

- 6 = Compressor 1
- 7 = Compressor 2
- 8 = Speed controlled fan

EC2-512 Condensing Unit Controller for up to 2 compressors and 2 fans

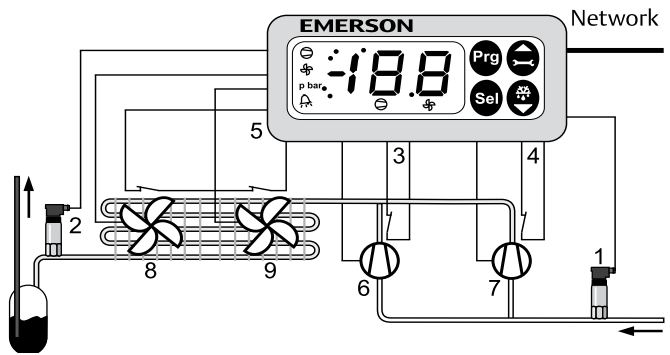

Inputs

- 1 = Suction pressure
- 2 = Condenser pressure
- 3 = Safety switch comp 1
- 4 = Safety switch comp 2
- 5 = Safety switches fans

Outputs

- 6 = Compressor 1
- 7 = Compressor 2
- 8 = Fan 1
- 9 = Fan 2

EC2-552 Condensing Unit Controller for 1 Digital Scroll and 1 single stage compressor

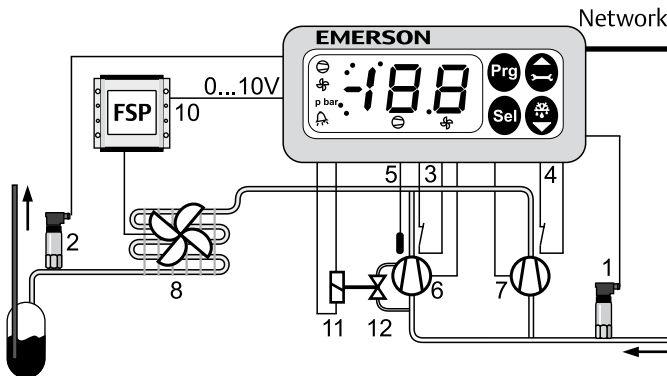

Inputs

- 1 = Suction pressure
- 2 = Condenser pressure
- 3 = Safety switch comp 1
- 4 = Safety switch comp 2
- 5 = Temperature input

Outputs

- 6 = Digital Scroll Compressor
- 7 = Single Stage Compressor
- 8 = Speed controlled fan
- 10 = Fan Speed Power Module
- 11 = PWM Digital Scroll Solenoid valve

Rack and Condenser Controllers Series EC3-600, -700, -800, -900

with Webserver Function and TCP/IP Ethernet protocol,
or with FTT10 LON Interface

Common Features

- Maintenance and alarm management
- Sensor failure handling
- Inputs for common low and common high pressure alarms
- Configuration data stored in non-volatile memory
- Aluminum enclosure for DIN-rail mounting
- Electrical connection via plug-in type screw terminals
- Operation and commissioning via local or remote PC
- Control of Copeland Digital Scroll Compressors (EC3-62x)
- CE approved
- Communication via:

Echelon LON Protocol for full network capabilities

or

TCP/IP Ethernet with Web Server function (see page 33)



EC3-600



ECD-000

Features of ECD-000

- Connection to EC3 Series via RJ45 Western digital plug. No further power cables required.
- 2½ digit display
- Indicator LEDs for compressor and alarm status
- 4 keys allow parameter modification if necessary
- Easy mounting in panels with 71 x 29 mm cutout
- IP65 if mounted in front panel

Selection table

Description	TCP/IP			LON		
	Type	Part No. single unit	Part No. Kit*	Type	Part No. single unit	Part No. Kit*

Rack Controller

for 8 compressors or 1 Digital Scroll and 7 single-stage compressors	EC3-652	807 534	808 046	EC3-651	807 533	808 045
for Multistage Compressors	EC3-672	807 562	808 029	EC3-671	807 561	808 028

*) Kit contains terminal kit, pressure transmitters PT4-07M and PT4-30M with cable assemblies, transformer 60VA, 1 NTC sensor 6m (EC3-65x only), see page 152.

Condenser Controller

for up to 6 stages, one with continuous control output 0...10V, heat recovery control	EC3-752	807 592	808 031	EC3-751	807 591	808 030
---	---------	---------	---------	---------	---------	---------

*) Kit contains terminal kit, pressure transmitter PT4-30M with cable assembly, transformer 60VA (see also page 152).

Dual Circuit Controllers

for 4 + 3 Compressors	EC3-812	807 602	808 033	EC3-811	807 601	808 032
for 4 single stage compressors or 1 Digital Scroll and 3 single-stage compressors & 3 Fans plus Speed Control	EC3-932	807 624	808 044	EC3-931	807 623	808 043

*) Kit contains terminal kit, pressure transmitters PT4-07M and PT4-30M with cable assemblies, transformer 60VA, and 5 NTC sensors 6m (see also page 152).

Accessories

Description	Cable Length	Type	Part No.
Terminal kit for EC3-65x / EC3-67x / EC3-93x		K03-110	807 656
Terminal kit for EC3-75x		K03-750	807 654
Terminal kit for EC3-81x		K03-640	807 653



K03-110

Display unit for EC3-600 to EC3-900	ECD-000	807 640
Connection cable EC3 to ECD 1m (3m/5m see page 51)	ECC-N10	807 860



ECD-000

NTC Sensor, single insulated for ambient temp. sensing -50 ... +50°C (10 kΩ at 25°C)	1,5m	ECN-S15	804 304
	3m	ECN-S30	804 305
	6m	ECN-S60	804 284
NTC Sensor, single insulated for discharge temp. sensing +50 ... +150°C (1 MΩ at 25°C)	6m	ECN-H60	804 359
	Humidity sensors temp. & humidity (wall)	ECS-TH1	804 355
temp. & humidity (duct)	ECS-TH2	804 356	



ECS-TH1

ECS-TH2

Pressure transmitter PT4 for suction and condensing pressure sensing (details see page 53)			
-0.8 ... 7 bar, 4 ... 20 mA		PT4-07M	802 332
0 ... 18 bar, 4 ... 20 mA		PT4-18M	802 333
0 ... 30 bar, 4 ... 20 mA		PT4-30M	802 334
0 ... 50 bar, 4 ... 20 mA		PT4-50M	802 335
Cable assembly (3m/6m see page 53)	1,5m	PT4-M15	804 803



PT4

PT4-Mxx

Transformer for DIN rail mounting, EN 60742 Class II			
230 VAC Input, 24 V output	25VA	ECT-323	804 424
	60VA	ECT-623	804 421



ECT-323

Infrared Remote Control	Language		
	English	EC2-IRE	804 345
	German	EC2-IRD	804 346
	French	EC2-IRF	804 347
	Spanish	EC2-IRS	804 348
	Italian	EC2-IRI	804 349



EC2-IRE

Technical Data

EC3 Controller

Supply voltage	24 VAC ±10%, 50/60 Hz Class II only
Power consumption	20 VA max.
Plug-in connector	Removable screw terminals
Digital I/Os	wire size 0.5 ... 2.5 mm ²
Analog I/O	wire size 0.14 ... 1.5 mm ²
Communication interface	LON: FTT10 TCP/IP: Ethernet with Web Server
Temperature storage	-20 ... +65°C
operating	0 ... +60°C
Humidity	0 ... 80% r.h. non condensing
Protection class	IP20
Weight	~ 810 g
Mounting	DIN-rail mount

ECD-000 Display Unit

Supply voltage	via ECC-N10 from EC3 controller
Display	Numeric segmental display, LED red, 2½ digits, numeric value device status and alarm indication
LEDs	1 x unit indicator bar/°C 1 x alarm LED
Connecting lead	1,0 m (ECC-N10)
Operating Keys	4 operating keys: programming, service/up, select/down
Temperature storage	-20 ... +65°C
operating	0 ... +60°C
Humidity	0 ... 80% r.h. non condensing
Protection class	IP 65 (front panel with gasket)
Weight	~ 52 g
Mounting	Panel mount (71x29mm cutout)

Block Diagrams

EC3-65 Rack Controller for 8 single-stage compressors or 7 single-stage Compressors and 1 Digital Scroll

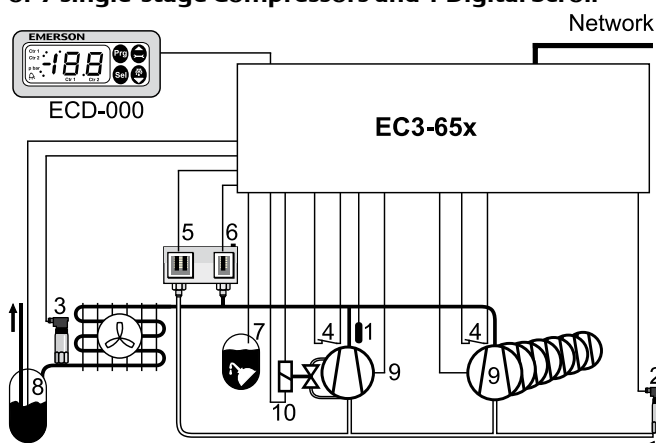

Inputs

- 1 = Discharge temperatures of up to 8 compressors
- 2 = Suction pressure
- 3 = Discharge pressure
- 4 = Serial alarm inputs for up to 8 compressors
- 5 = Low pressure alarm
- 6 = High pressure alarm
- 7 = Oil level alarm
- 8 = Refrigerant level alarm

Outputs

- 9 = for up to 8 compressors
- 10 = to control a digital scroll

EC3-67x Rack Controller for Capacity Controlled Compressors

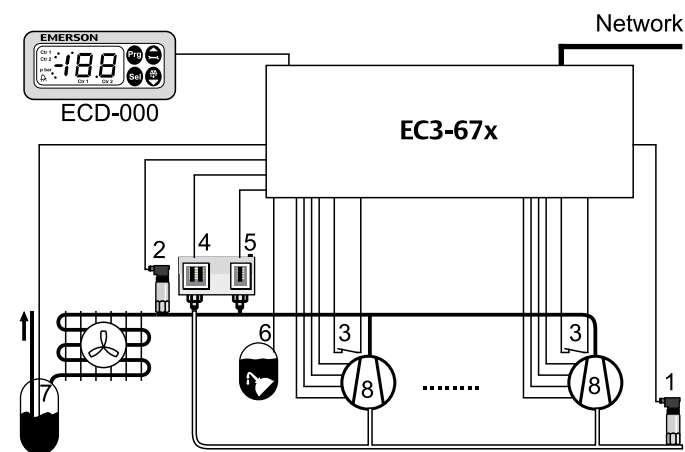

Inputs

- 1 = Suction pressure
- 2 = Discharge pressure
- 3 = Serial alarm inputs for up to 6 compressors
- 4 = Low pressure alarm
- 5 = High pressure alarm
- 6 = Oil level alarm
- 7 = Refrigerant level alarm

Outputs

- 8 = 12 outputs for up to 6x2 / 4x3 / 3x4 capacity controlled compressors

EC3-75x Condenser Controller

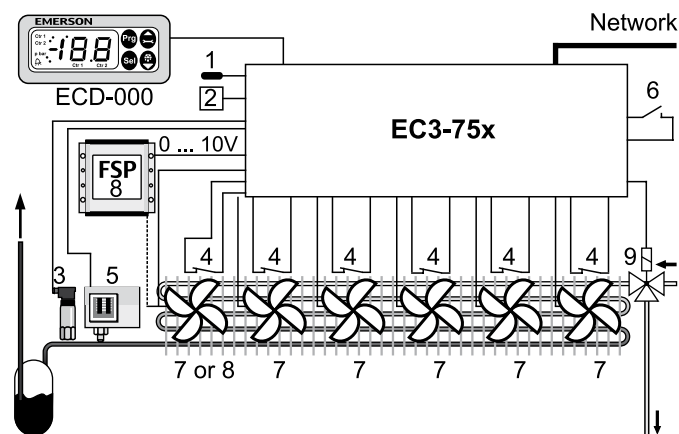

Inputs

- 1 = Ambient temperature
- 2 = Humidity sensor
- 3 = Condensing pressure
- 4 = Serial alarm inputs for up to 6 fans
- 5 = High pressure alarm
- 6 = Heat recovery demand

Outputs

- 7 = For up to 6 stages, from which 1 can be speed controlled
- 8 = Speed controlled fan (see 7)
- 9 = Heat recovery solenoid

Block Diagrams

EC3-81x Dual Circuit Rack Controller (4 + 3 compressors)

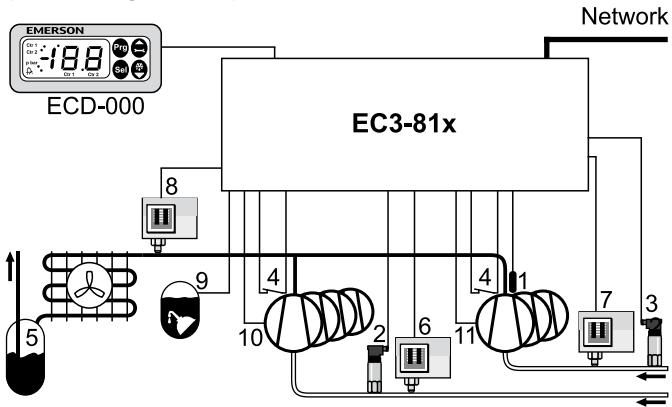

Inputs

- 1 = Discharge temperature inputs of 3 compressors
- 2 = Suction pressure group A
- 3 = Suction pressure group B
- 4 = Serial alarm input for each compressor respectively
- 5 = Refrigerant level alarm
- 6 = Low pressure alarm group A
- 7 = Low pressure alarm group B
- 8 = High pressure alarm
- 9 = Oil level alarm

Outputs

- 10 = For up to 4 compressors suction group A
- 11 = For up to 3 compressors suction group B

EC3-93x Rack and Condenser Controller (up to 4 compressors + condenser)

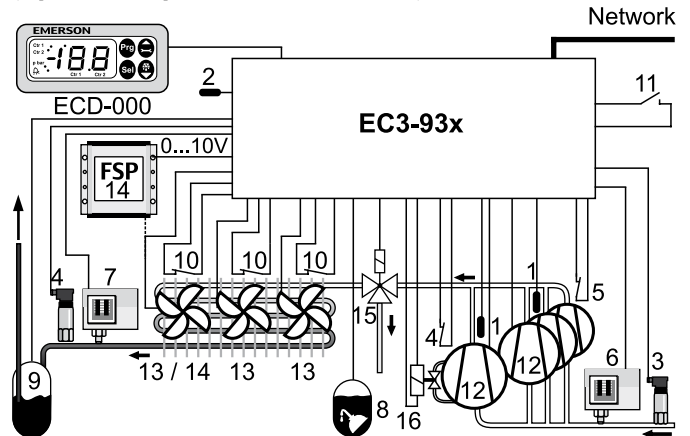

Inputs

- 1 = Discharge temperature
- 2 = Ambient temperature
- 3 = Suction pressure
- 4 = Condensing pressure
- 5 = Serial alarm inputs for 4 compressors
- 6 = Low pressure alarm
- 7 = High pressure alarm
- 8 = Oil level alarm
- 9 = Refrigerant level alarm
- 10 = Serial alarms for 3 fans
- 11 = Heat recovery demand

Outputs

- 12 = Up to 4 compressors
- 13 = Up to 3 fans, from with 1 fan can be speed controlled
- 14 = Speed controlled fan (see 13)
- 15 = Heat recovery solenoid
- 16 = to control a digital scroll

Network Accessories

Description	Cable Length	Type	Part No.
Echelon USB-FTT10 interface Stick (with USB cable)		ECC-034	804 385
RJ45 connection box		ECC-007	804 508
FTT10A free topology termination to RJ45 conn.		ECC-010	804 511
RJ45 to RJ45 Ethernet connection cable	1.5m	ECC-N10	807 860
RJ45 to RJ45 Ethernet connection cable	3.0m	ECC-N30	807 861
RJ45 to RJ45 Ethernet connection cable	5.0m	ECC-N50	807 862
RJ45 to open cable	3.0m	ECC-014	804 381
RJ45 to 4pin-connector cable for EC2 TCP/IP Contr.	6.0m	ECX-N60	804 422
ANL-220 Dongle (USB)		ECC-032	804 384
ANL-220 Demo version		ECC-024	804 379



ECC-034



ECC-007



ECC-010

Examples for Use of Network Accessories

FTT10 Free topology network with ECC-007 RJ45 connection box, ECC-014 cable with RJ45 connector and ECC-010 network termination.

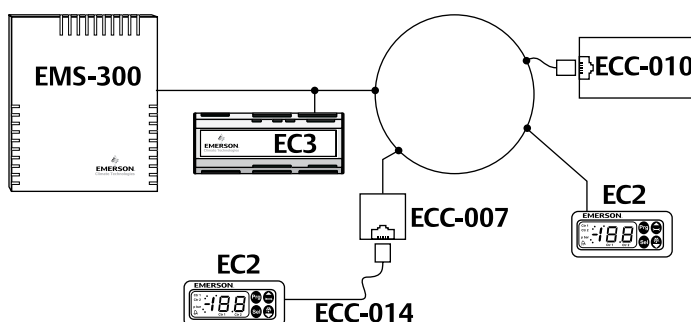

LON connected to Laptop ECC-034 interface.

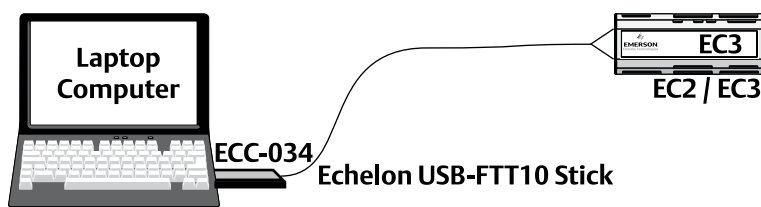

ECC-N10 RJ45 to RJ45 cable for connection between EC3 and ECD

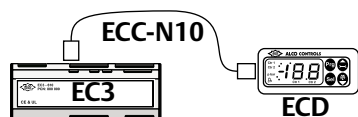

Electronic Smart Starter ESC-255 / ESC-325

The electronic Smart Starter ESC-255 / ESC-325 is used for switching, protection and starting current limitation of single phase compressors in refrigeration and air-conditioning applications

Features

- For motors with up to 25A / 32A max. operating current
- Limitation of starting current to less than 45A
- Self adjusting to motor current - no manual adjustment or calibration necessary
- Many motor protection functions:
 - Low voltage shut down
 - Locked rotor recognition and shutdown
 - Delay function to limit number of motor starts per hour
- Self diagnostics
- Indicator LED
- Thyristor protected contactor for long life
- No extra motor contactor needed
- Easy Installation



ESC-255

Standards:

- per Low Voltage Directive (EN 60947-1/EN 60947-5-1)
- EN 60947-4-2 Contactors and motor starters - AC semiconductor motor controllers and starters Flicker (EN 61000-3-3 / IEC-1000-3-11)
- Safety and environmental requirements for refrigeration systems and heat pumps (EN 378)

Selection Chart ESC

Type	Part No.	Max. compressor running current
Smart Starter ESC-255	805 175	25A
Smart Starter ESC-325	805 176	32A

including mounting clip, plug, connectors, operating instructions

Technical Data

Operating voltage	230 V 50 Hz nominal
Compressor starting current	limited to max. 45A
Operating temperature	-20 ... +65°C non condensing
Storage temperature	-40 ... +85°C non condensing
Start capacitor	200 ... 240 uF

Weight	400 g
Protection acc. IEC 529	IP 20
Max. vibration	4 g (at 10 ... 1000 Hz)
Time delay after stop	3 min

Wiring Diagram

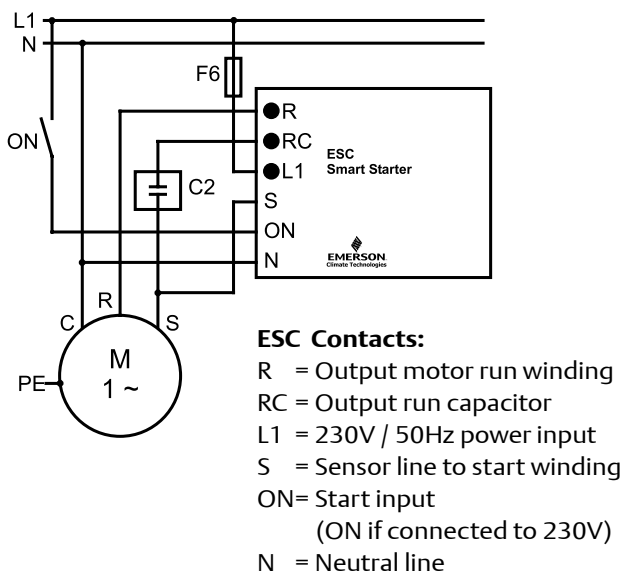

Start Current vs Time

- (a) Motor without current limitation
- (b) Large motor with ESC Smart Starter
- (c) Small motor with ESC Smart Starter

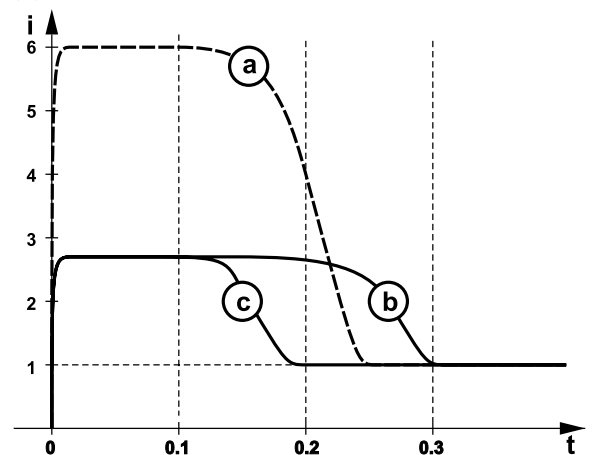

Pressure Transmitter Series PT4

PT4 Pressure Transmitters convert a pressure into a linear electrical output signal.

Features

- Pressure sensitive piezo-based cell with strong primary output signal for precise and noiseless operation
- Sealed gauge absolute pressure reference principle provides the regulation accuracy independent from atmospheric pressure variation
- Vibration, shock and pulsation resistant
- Protection class IP 65
- Easy install M12 electrical connection with pre-assembled cable assemblies available in various lengths
- Compact dimensions
- Output signal 4 to 20 mA
- Calibrated for specific temperature and pressure ranges to fulfill application demands in airconditioning and refrigeration systems
- Variable supply voltage
- Standard pressure ranges compatible with former ALCO pressure transmitters



PT4-xxM

PT4-Mxx

Standards:

- per EMC Directive

Options

- Other pressure ranges and calibrations

Selection Chart Transmitters

Type	Part No.	Output signal	Pressure range (bar)	Max. working pressure PS (bar)	Pressure Connection
PT4-07M	802 332	4 ... 20 mA	-0.8 ... 7	25	7/16" -20 UNF (with schrader valve opener)
PT4-18M	802 333		0 ... 18	33	
PT4-30M	802 334		0 ... 30	33	
PT4-50M	802 335		0 ... 50	50	

Cable Assemblies

Type	Part No.	Temperature range (°C)	Cable length (m)	Leads
PT4-M15	804 803	-50 ... +80 °C static application	1.5	2 x 0,34 mm ²
PT4-M30	804 804		3.0	
PT4-M60	804 805	-25 ... +80 °C mobile application	6.0	

Technical Data

Supply Voltage Range (polarity protected)	Nominal 24 Vdc 8... 30 Vdc
Operating current	max. 20 mA output
Protection class acc. to EN 60529	IP65
Load resistance	$R_L \leq \frac{U_B - 8.0V}{0.02A}$
Temperatures	
Operating ambient housing	-40.....80 °C
Medium	-50...135 °C
Transportation and storage	-40.....85 °C

Sensor lifetime at full stroke at 25°C	> 5.000.000 cycles
Burst pressure	>150 bar
Medium compatibility not suitable for ammonia and inflammable refrigerants!	HFC, HCFC
Materials	
Housing cover, pressure connector, diaphragm with medium contact	Stainless steel 1.4435 / AISI 316L
Vibration at 10 ... 2000 Hz	max. 4 g

Accuracy Performance

	Temperature range	Total error*
PT4-07M	-40 ... +80°C	≤ ± 1 % FS
PT4-18M	-20 ... +80°C	≤ ± 1 % FS
PT4-30M	0 ... +40°C	≤ ± 1 % FS
	-20 ... +60°C	≤ ± 2 % FS
	-40 ... +80°C	typically ≤ ± 2 % FS
PT4-50M	0 ... +40°C	≤ ± 1 % FS
	-20 ... +60°C	≤ ± 2 % FS
	-30 ... +80°C	typically ≤ ± 2 % FS

*) Total error includes non-linearity, hysteresis, repeatability as well as offset and span drift due to the temperature changes.

Note: % FS is related to Percentage of Full sensor Scale.

Electrical connection

Pressure transmitters PT4 with current output (2-wire connection) offer following advantages:

1. More suitable for signal transmission over long distances
2. Higher immunity to electromagnetic interference

Note: Changing the length of the electrical connection lead beyond 1.5 m can have a negative impact on electromagnetic compatibility. Additional protection may be required.

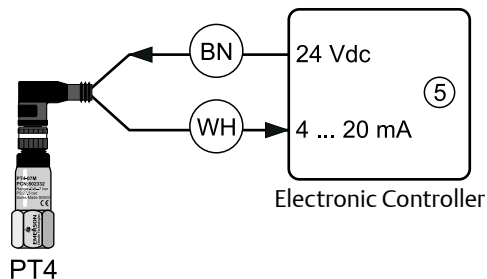

BN = brown, supply voltage 24V
 WH = white, output signal 4 ... 20mA
 (5) = Electronic Controller e.g. EC2 & EC3 Series

Electronic Fan Speed Controller Series FSY

Features

- Pressure actuated fan speed control
- Adjustable pressure for Cut-off
- High Voltage Triac (800 Volts)
- Integrated protection circuit against voltage peaks
- Compact design
- Protection IP65
- Easy mounting and adjustment
- Easy retrofit in existing plants
- No additional gasket required (completely molded into plug)
- Multi-position plug with EMC filter incl. 1,5m (opt. 3 and 6m) cable for flexible installation
- per EC 89/336/EC (together with FSF cable)



FSY

Selection Table

Type	Part No.	Operational Current A	Adjustment Range bar	Factory Setting bar	Max. Operating Pressure PS bar	Test Pressure PT bar	Pressure Connection
FSY-41S	0 715 533	0.1 ... 4	4.0 ... 12.5	8.0	27	30	S: 7/16"-20 UNF female
FSY-42S	0 715 534						S: 7/16"-20 UNF female
FSY-42U	0 715 535		9.2 ... 21.2	15.0	32	36	U: 6mm - ODF
FSY-42X	0 715 536						X: 1/4" - ODF
FSY-43S	0 715 537		12.4 ... 28.4	21.8	43	48	S: 7/16"-20 UNF female
FSY-43U	0 715 538						U: 6mm - ODF
FSY-43X	0 715 539	X: 1/4" - ODF					

Cable Assemblies with plug and EMC filter

Type	Part No.	Temperature Range °C	Cable length mtr.
FSF-N15	804 640	-25/+80	1.5
FSF-N30	804 641		3.0
FSF-N60	804 642		6.0
FSF-L15	804 643	-50/+80	1.5



FSF-N15

Technical Data

Supply voltage	230V AC +10%, -15%
Nominal current (see diagram below)	0.1 ... 4 (3) A
Starting current	max. 8 Ampère/5 sec.
Medium compatibility	HFC, HCFC (not released for use with inflammable refrigerants)
Protection Class according to IEC529 /DIN 40050	IP 65 (with fitted connectors FSF-xxx)
Temperature ranges	ambient -20 to +55 °C >40°C see diagramm storage, transportation -30 to +70°C medium -20 to +70°C

Max. Current vs Ambient Temperature

Ambient Temperature (°C)	Current (A)
30	4.0
35	4.0
40	4.0
45	3.5
50	3.0
55	2.5

Pressure change per turn of adjustment screw	FSY-41: 4,0 .. 12,5 bar clockwise ~ +1.2 bar counter clockwise ~ -1.2 bar
	FSY-42: 9,2 .. 21,2 bar clockwise ~ +2.5 bar counter clockwise ~ -2.5 bar
	FSY-43: 12,4 .. 28,4 bar clockwise ~ +3.3 bar counter clockwise ~ -3.3 bar
Proportional Range	FSY-41: 2,5 bar FSY-42: 3,8 bar FSY-43: 4,6 bar
Weight	approx. FSY-41, -42 0.12 kg FSY-43 0.15 kg FSF-N15 0,14 kg FSF-N30 0,20 kg FSF-N60 0,22 kg
Housing material	PC and PA

Function Diagram

The control behaviour can be easily described by looking at the function of output voltage versus input pressure: In the **maximum range** the FSY provides a constant output voltage of approximately 1% below the supply voltage. The fan is running at maximum speed. Along the **proportional range** the output voltage varies between maximum and minimum voltage of approximately 45% of the supply voltage. This causes the fan to slow down from maximum to minimum speed.

Further decrease of pressure in the minimum range leads to cut-off of the fan motor. Reincrease of input pressure will start the motor with a hysteresis of approximately 0.7 bar to avoid cycling. The pressure from which motor cuts off is adjustable (see pressure range).

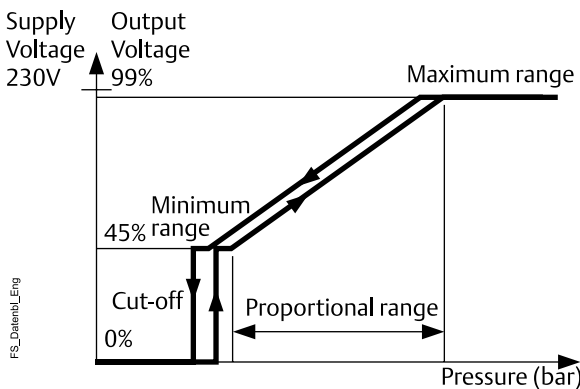

Electronic Fan Speed Power Module FSP and Control Module FSE

Features FSP

- Can be used in combination with ALCO FSE Control Module, EC2, EC3 and other electronic controllers which provide a 0...10V output signal for condensing pressure control
- Versions for 3- and 1- phase motors approved for phase cut operation
- Paralleling of fan motors up to maximum current
- Reduced fan noise level during low ambient temperature conditions
- Energy saving due to improved cooling efficiency
- Short start impulse during partial load to overcome friction and windmilling
- Easy installation with cables for power supply and motor connection factory wired
- IP67 protection for outdoor mounting



FSE Control Module



FSP Power Module

Standards:

- per Low Voltage Directive
- per EMC

Selection Chart FSP

Type	Part No.	Supply Voltage	Current Range (A)	Max. Start Current, max. 1sec (A)	Power Supply Cable Length (mtr)	Motor Cable Length (mtr)	Wire Diameter	Weight (g)
FSP-150	800 370	230V /50 Hz	0.3 - 5	15 A	1,5	0,75	3 x 1 mm ²	1 050
FSP-180	800 373		0.3 - 8	24 A				
FSP-340	800 376	400V/3/50 Hz	0.3 - 4	12 A				5 x 1 mm ²

Selection Chart FSE Control Modules

Type	Part No.	Refrigerants	Adjustment Range P _{cut} * (bar)	Cut-off Pressure factory set (bar)	Test Pressure	Pressure Connection	Weight (g)
FSE-01S	804 701	R 134a	4 ... 12.5	7.8	30 bar	7/16"-20 UNF female	125
FSE-02S	804 706	R 22, R 404A, R 407C, R 507	10 ... 21	15.5	36 bar	7/16"-20 UNF female	125
FSE-03S	804 711	R 410A	12 ... 28	20.4	48 bar	7/16"-20 UNF female	150

* Pressure at which fan is cut-off.

Selection Chart Cable Assemblies

Temperature Range -25 to 80°C / no UL		Temperature Range -50 to 80°C / UL appr.		Length (mtr.)	Weight (g)
Type	Part No.	Type	Part No.		

for connection to FSE Control Module:

FSE-N15	804 680	FSE-L15	804 683	1.5	80
FSE-N30	804 681	FSE-L30	804 684	3.0	130
FSE-N60	804 682	FSE-L60	804 685	6.0	220

for connection to EC2, EC3 and other controllers:

		FSP-L15	804 693	1.5	
		FSP-L30	804 694	3.0	
		FSP-L60	804 695	6.0	



Selection Dependent on Product Combination

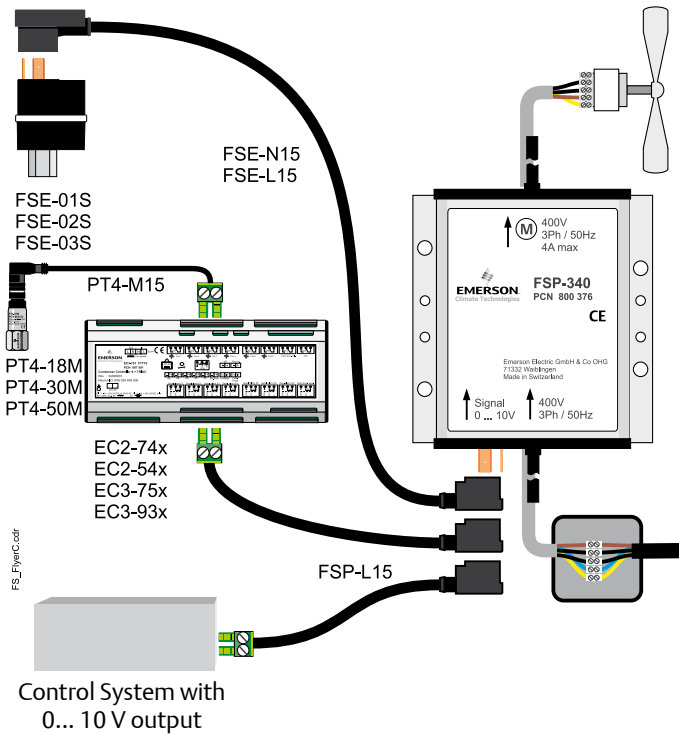

Selection

1. Select a **Power Module FSP** by the total maximum operating current and phases of condenser fan motors
2. Select a **Control Module FSE** based on the pressure requirements of the refrigerant used:
 - FSE-01S for R 134a,
 - FSE-02S for R 22 / R 404 A / R 407C / R 507
 - FSE-03S for R 410A
 - or a controller of the EC Series
 - or another electronic controller which provides a 0...10 V output signal
3. Select a **Cable Assembly**
 - a) for connection of **FSE to FSP**:
 - 3 lengths: (1.5 - 3.0 - 6.0 m) and
 - 2 temperatures: **FSE-N**: -25 ... +80°C
FSE-L: -50 ... +80°C
 - b) or for use with an electronic controller with 0...10V signal output (e.g. EC2-74x, EC2-54x, EC3-75x, EC3-92x):
 - 3 lengths (1.5 - 3.0 - 6.0 m) and
 - 1 temperature: **FSP-L**: -50 ... +80°C

Function Diagram

The behaviour of FSP together with FSE can be described by the following control diagram:

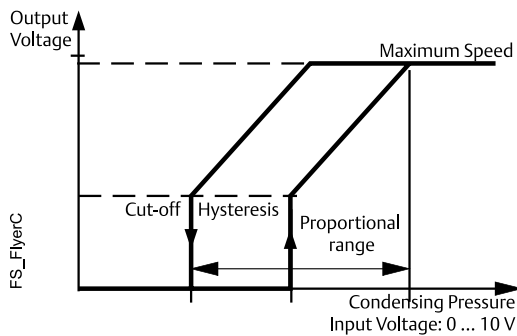

The top curve describes the fan speed at decreasing, the lower curve at rising pressure. At high condensing pressure fan is running with maximum speed (top right). In the proportional range of the curve fan speed is decreased with pressure. If the pressure falls below the specified limit the fan is cut-off. A large hysteresis is built-in to prevent fan cycling at this point. Pressure must increase by approximately 1 bar before fan restarts. A short start pulse helps fan to overcome friction or windmilling before it supplies the proportional value. Along the proportional range the fan speed varies between 20% and 100% for 3-phase motors and between 30% and 100% for single phase motors.

Technical Data FSP

Temperature Range Operation	-20°C to +65°C
Protection class (IEC 529 / EN 60529)	IP 67
Signal Input Voltage	0 ... 10 VDC
Mounting	Direct with screws or with optional DIN Rail Kit FSP-K00 Ord. No. 800 379

FSE

Temperature Range Operation	-20°C to +65°C
Protection class (IEC 529 / EN 60529)	IP 65
Supply Voltage	10V, supplied by FSP Module
Operating Current 0 ... 10 VDC output	max. 1 mA
Medium Compatibility	HFC, HCFC, synth. / mineral oils
Pressure Connection	FSE-01S / FSE-02S brass FSE-03S stainless steel

Monitoring Server Series EMS-300

with LON and SNMP protocols

Features

- Fully pre-configured and tested; all Hardware and Software installed
- Pre-defined schematics for all EC series controllers allowing quick installation
- Customisation made easy with familiar Windows® pick, copy & paste commands
- Web Server functionality for remote access from any PC with Microsoft Internet Explorer® browser; no special software needed
- Access via Internet, Intranet
- Dial-up possible using externally mounted modem supplied separately
- Storage of temperature, pressure and other operational data
- Visualisation of the entire refrigeration system including the status of all networked controllers, all current operational and stored data
- Export of data in XML format for further analysis
- Collection, handling, indication and routing of alarm states
- System watchdog with processor temperature monitoring including system auto reboot feature
- Open and interoperable LON communications interface and protocol (FTT10 LON interface)
- Echelon® LNS Server license included
- Monitor, keyboard, mouse and Ethernet connections for local configuration and visualisation (supplied separately)
- Rugged housing for wall mounting
- CE approved



EMS-300

Options

- ISDN or analog modem (external option)
- Third party communications protocols upon request
- Network accessories see page 51

Selection

Description	Type	Part No.
Monitoring Server	EMS-300	804 411

Technical Data

Processor	min. Intel® Pentium® M 1.7 GHz FSB 400	Supply Voltage	12VAC 180 ... 264 VAC; 50/60Hz transformer supplied
Memory	min. 512 MB	Temperatures	Operating 0 ... +45°C Storage 0 ... +60°C
Hard Drive	min. 40GB (27GB for user)	Operating System	MS Windows XP Professional, English Built-in watchdog functions with auto reboot
I/O Ports	10/100 Ethernet (RJ45) 4 USB ports 2 serial ports (2 x 9-pin D-connector; suitable for RS485/ RS232) 1 PS/2-style keyboard: 6-pin 1 PS/2-compatible mouse: 6-pin 1 S-VGA display DVI output	Dimensions	L: 280H mm x W: 230 mm x D: 80mm
LON	TP-1250, FTT-10 and RS485	Weight	~ 1.95kg
Protection class	IP20	Mounting	Wall mounting, 4 x fixtures



Thermo[®]-Expansion Valves

Expansion Valves

Basic Terms and Technical Information

Operating principles

ALCO Thermo®-Expansion valves control the superheat of refrigerant vapour at the outlet of the evaporator. They act as a throttle device between the high pressure and the low pressure sides of refrigeration systems and ensure that the rate of refrigerant flow into the evaporator exactly matches the rate of evaporation of liquid refrigerant in the evaporator. Thus the evaporator is fully utilized and no liquid refrigerant may reach the compressor.

Description of bulb charges

The application ranges of Thermo®-Expansion valves are heavily influenced by the charge selected.

Liquid charges

The behaviour of Thermo®-Expansion valves with liquid charges is exclusively determined by temperature changes at the bulb and not subject to any cross-ambient interference. They feature a fast response time and thus react quickly in the control circuit. Liquid charges cannot incorporate MOP functions. Maximum bulb temperatures shall not exceed 75° C.

Gas charges

The behaviour of Thermo®-Expansion valves with gas charges will be determined by the lowest temperature at any part of the expansion valve (power assembly, capillary tube or bulb). If any parts other than the bulb are subject to the lowest temperature, malfunction of the expansion valve may occur (i.e. erratic low pressure or excessive superheat). ALCO thermo expansion valves with gas charges always feature MOP functions and include ballasted bulbs. Ballast in the bulb leads to slow opening and fast closure of the valve. Maximum bulb temperature is 120° C.

Adsorption charges

These charges feature control characteristics much like MOP charges but avoid the difficulties of cross-ambient interference. Response time is slow but perfectly suitable for common refrigeration systems. Maximum bulb temperature is 130° C.

MOP (Maximum Operating Pressure)

MOP functionality is somewhat similar to the application of a crankcase pressure regulator. Evaporator pressures are limited to a maximum value to protect compressor from overload conditions.

MOP selection should be within maximum allowed low pressure rating of the compressor and should be at approximately 3K above evaporating temperatures.

Practical hint: Superheat adjustments influence the MOP:

Increase of superheat: Decrease of MOP
Decrease of superheat: Increase of MOP

Static superheat

ALCO Thermo®-Expansion valves are factory preset for optimum superheat settings. This setting should be modified only if absolutely necessary.

The readjustment should be at the lowest expected evaporating temperature.

Subcooling

Subcooling generally increases the capacity of refrigeration system and may be accounted for when dimensioning an expansion valve by applying the correction factor K_t . The capacity corrections for evaporating temperature, condensing temperature and subcooling are all incorporated in K_t . These are in particular the liquid density upstream from the expansion valve, the different enthalpies of liquid and vapour phase refrigerants as well as certain part of flash gas after expansion. The percentage of flash gas differs with various refrigerants and depends on system conditions.

Heavy subcooling results in very small flash gas amounts and therefore increases expansion valve capacities. These conditions are not covered by K_t . Likewise, small flash gas amounts lead to reduced evaporator capacities and may result in substantial discrepancies between the capacities of the Thermo®-expansion valve and the evaporator. These effects must be considered during component selection when designing refrigeration circuits. In cases when subcooling exceeds 15 K, sizing of components (K_t , $K_{\Delta p}$) should be modified accordingly. The field practice indicates the following correction factors can be used to compensate the effect of the subcooling (liquid hammering) in addition to the use of correction factors K_t , and $K_{\Delta p}$.

Subcooling	20K	30K	40K	50K	60K
Correction factor	0,8	0,7	0,6	0,5	0,4

ALCO CONTROLS will be happy to assist you. Please contact application engineering department.

Dimensioning

To correctly select a Thermo®-Expansion valve on a system, the following design conditions must be available:

- Cooling capacity Q_o
- Effective pressure differential across Thermo®-Expansion valve Δp
- Evaporating temperature/pressure
- Lowest possible condensing temperature/pressure
- Liquid temperature
- Type of refrigerant

As opposed to single substances (e.g. R22, R134a etc.) where the phase change takes place at a constant temperature/pressure, the evaporation and condensation of **zeotropic blend R407C** is in a gliding form (e.g. at a constant pressure the temperature varies within a certain range) through evaporators and condensers.

The evaporating/condensing pressure must be determined at saturated temperatures (bubble/dew points) for dimensioning of Thermo®-Expansion valves.

To facilitate **valve dimensioning** for other than the standard conditions ALCO offers an Excel based **Selection Tool**. This can be ordered from all Copeland sales offices. See www.emersonclimate.com/europe for contact addresses, email or phone numbers.

Example

Cooling capacity of a system: 18 kW
 Refrigerant: R 407C
 Condensing temperature (saturated liquid): +35°C
 (Condensing pressure will be 15.5 bar)
 See appendix page 155 for
 Evaporating temperature (saturated vapour): 0°C
 (Evaporating pressure will be 4.61 bar)
 Subcooling: 1 K
 Pressure drops through liquid line: 2.2 bar
 Pressure drops through evaporator: 0.3 bar
 Required type of Thermo®-Expansion valve: T-series

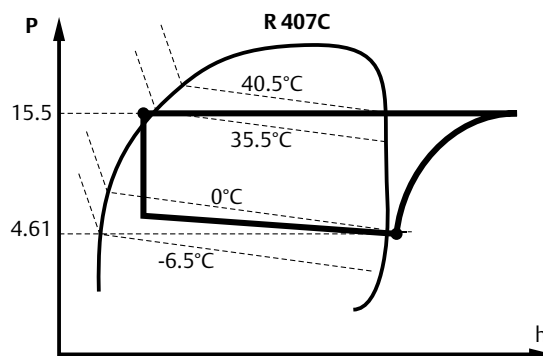

To calculate the nominal capacity the following formula has to be used:

Cooling capacity x K_t x K_{Δp} = Nominal capacity

1. Selected **K_t-factor** according to refrigerant, liquid and evaporating temperature from table on page 76.

$$K_t = 0.98 \text{ (for this example)}$$

2. Determine pressure differential across the Thermo®-Expansion valve using condensing pressure, subtract evaporating pressure and all other possible pressure losses (pressure drops in evaporator, drier, solenoid valve, liquid distribution...).

For this example:

$$\Delta p = 15.5 - (4.61 + 2.2 + 0.3) = 8.39 \text{ bar}$$

Select **K_{Δp}** factor from table on page 76:

$$K_{\Delta p} = 1,15 \text{ (for this example)}$$

3. Multiply cooling capacity with **K_t** and **K_{Δp}**, to find nominal capacity for Thermo®-Expansion valve.

$$Q_n = 18 \times 0.98 \times 1.15 = 20.29 \text{ kW}$$

Select Thermo®-Expansion Valve from table on page 72: TCLE 550 NW (for this example).

Please note that all evaporating/condensing temperatures in this catalogue are based on saturated vapour/liquid temperatures.

Selection Guide for Expansion Valves

Series	Selection Criteria				Catalogue Page
	Capacity Range kW (R 404A)	Evaporating Temperature Range °C	Main Application	Features	
TI	0,5 to 14,2	+20 to -45	Refrig./Air-Cond. Heat Pumps	Interchangeable Orifices	64
TX3	0,8 to 15,0	+20 to -45	Refrig./Air-Cond. Heat Pumps	Hermetic, Superheat adjustable, optional with check valve	*
TX6	13.3 to 57.0	+20 to -45	Air-Cond. Heat Pumps	Hermetic Superheat adjustable	70
T	2 to 209	+30 to -45	Refrig./Air-Cond. Heat Pumps	Interchangeable Orifices, Power-Assembly and Flange	72
ZZ	1,9 to 81,2	-45 to -120	Low Temperature Application	Interchangeable Orifices, Power-Assembly and Flange	77
L	2 to 154	+30 to -50	Liquid Injection Superheat Control	Interchangeable Orifices, Power-Assembly and Flange	80
935	5,2 to 43,5	+30 to -45	Liquid Injection Temperature Control	Interchangeable Orifices, Power-Assembly and Flange	82

* Please ask your local Copeland sales office for datasheets or download from www.emersonclimate.com/europe

Thermo®-Expansion Valves Series TI

Exchangeable Orifices

Features

- 6 valve bodies in conjunction with 8 cages lead to 48 thermo expansion valves to cover a very wide range of applications
- Very good stability is attained because of the large forces generated by the large diaphragm diameter
- With capacities between 0.4 kW and 14.2 kW (R 404A) they are ideally suited for service work
- Tailored charges for different applications
- Constant superheat across a wide application range
- Solder and flare connections available
- Capillary tube length 1.5 m
- PS: 31 bar, TS: -45 ... +75°C
- No CE marking according art. 3.3 PED 97/23 EC



TI(E)



TI(E)



Solder Adapter

Type Code

TI S E - M W

Valve series TI

Connection type

S: Brazing (outlet & external equaliser connection)
: Flare

Equaliser

E: External
: Internal

Refrigerant Charge

W: Liquid
Wxxx: Gas MOP
ADxxx: Adsorption

TI(E) Valve bodies – flare type Valve bodies without cage and nut

MOP (valve closed)	Evaporating temperature range °C	Equaliser	Refrigerant							
			R 134a alternative R 12, R 401A/B, R 408A/B, R 413A		R 22		R 404A / R 507 alternative R 502, R 402A/B, R 403B, R 407A/B, R 408A		R 407C	
			Type	Part No.	Type	Part No.	Type	Part No.	Type	Part No.
less	-45 to +20	intern	TI-MW	800 975	TI-HW	800 649	TI-SW	800 553	TI-NW	800 001
		extern	TIE-MW	800 974	TIE-HW	800 652	TIE-SW	800 552	TIE-NW	800 003
-20°C	-45 to -27	intern	-	-	-	-	TI-SAD-20	800 554	-	-
		extern	-	-	-	-	TIE-SAD-20	800 555	-	-
0°C	-45 to -3	intern	-	-	-	-	TI-SW75	800 501	-	-
		extern	-	-	-	-	TIE-SW75	801 331	-	-
+14°C	-45 to +10	intern	TI-MW55	800 543	-	-	-	-	-	-
		extern	TIE-MW55	800 997	-	-	-	-	-	-
+15°C	-45 to +12	intern	-	-	TI-HW100	800 991	-	-	-	-
		extern	-	-	TIE-HW100	800 992	-	-	-	-
+10°C	-45 to 0	intern	-	-	-	-	TI-SAD10	800 962	-	-
		extern	-	-	TIE-HAD10	800 969	TIE-SAD10	800 959	-	-

Inlet: Flare 5/8"-18UNF for 6mm, 8mm, 10mm, 1/4", 5/16" and 3/8" tubes
Outlet: Flare 3/4"-16UNF for 12mm and 1/2" tubes

TIS(E) Valve bodies – solder type metric

Valve bodies without cage and nut

MOP (valve closed)	Evaporating temperature range °C	Equaliser	Refrigerant							
			R 134a alternative R 12, R 401A/B, R 408A/B, R 413A		R 22		R 404A / R 507 alternative R 502, R 402A/B, R 403B, R 407A/B, R 408A		R 407C	
			Type	Part No.	Type	Part No.	Type	Part No.	Type	Part No.
less	-45 to +20	intern	TIS-MW	800 976	TIS-HW	800 947	TIS-SW	800 549	TIS-NW	800 008
		extern	TISE-MW	800 979	TISE-HW	800 950	TISE-SW	800 548	TISE-NW	800 009
-20°C	-45 to -27	intern	-	-	-	-	TIS-SAD-20	800 556	-	-
		extern	-	-	-	-	TISE-SAD-20	800 557	-	-
0°C	-45 to -3	intern	-	-	-	-	TIS-SW75	800 502	-	-
		extern	-	-	-	-	TISE-SW75	800 503	-	-
+14°C	-45 to +10	intern	TIS-MW55	800 546	-	-	-	-	-	-
		extern	TISE-MW55	800 547	-	-	-	-	-	-
+15°C	-45 to +12	intern	-	-	TIS-HW100	800 993	-	-	-	-
		extern	-	-	TISE-HW100	800 994	-	-	-	-
+10°C	-45 to 0	intern	-	-	-	-	TIS-SAD10	800 938	-	-
		extern	-	-	-	-	TISE-SAD10	800 939	-	-

Inlet: Flare 5/8"-18UNF for 6mm, 8mm, 10mm, 1/4", 5/16" and 3/8" tubes
 Outlet: Solder ODF for 12mm tubes

TIS(E) Valve bodies – solder type inch

Valve bodies without cage and nut

MOP (valve closed)	Evaporating temperature range °C	Equaliser	Refrigerant							
			R 134a alternative R 12, R 401A/B, R 408A/B, R 413A		R 22		R 404A / R 507 alternative R 502, R 402A/B, R 403B, R 407A/B, R 408A		R 407C	
			Type	Part No.	Type	Part No.	Type	Part No.	Type	Part No.
less	-45to +20	intern	TIS-MW	800 978	TIS-HW	800 953	TIS-SW	800 551	TIS-NW	800 004
		extern	TISE-MW	800 977	TISE-HW	800 956	TISE-SW	800 550	TISE-NW	800 007
-20°C	-45 to -27	intern	-	-	-	-	TIS-SAD-20	800 558	-	-
		extern	-	-	-	-	TISE-SAD-20	800 559	-	-
0°C	-45 to -3	intern	-	-	-	-	TIS-SW75	800 504	-	-
		extern	-	-	-	-	TISE-SW75	800 505	-	-
+14°C	-45 to +10	intern	TIS-MW55	800 544	-	-	-	-	-	-
		extern	TISE-MW55	800 545	-	-	-	-	-	-
+15°C	-45 to +12	intern	-	-	TIS-HW100	800 995	-	-	-	-
		extern	-	-	TISE-HW100	800 996	-	-	-	-
+10°C	-45 to 0	intern	-	-	-	-	TIS-SAD10	800 989	-	-
		extern	-	-	-	-	TISE-SAD10	800 990	-	-

Inlet: Flare 5/8"-18UNF for 6mm, 8mm, 10mm, 1/4", 5/16" and 3/8" tubes
 Outlet: Solder ODF for 1/2" tubes

Cages with strainer for inlet connection

Type	Part No.	Nominal Capacity Qn (kW)				
		R 134a	R 22	R 404A	R407C	R 507
TIO-00X	800 532	0,3	0,5	0,4	0,5	0,4
TIO-000	800 533	0,8	1,3	1,0	1,4	1,0
TIO-001	800 534	1,9	3,2	2,3	3,5	2,3
TIO-002	800 535	3,1	5,3	3,9	5,7	3,9
TIO-003	800 536	5,0	8,5	6,2	9,2	6,2
TIO-004	800 537	8,3	13,9	10,1	15,0	10,1
TIO-005	800 538	10,1	16,9	12,3	18,3	12,3
TIO-006	800 539	11,7	19,5	14,2	21,1	14,2

Nominal capacity (Qn) is based on the following conditions:

Refrigerant	Evaporating temperature	Condensing temperature	Sub- cooling
R 407C	+4°C dew point	+38°C bubble p. +43°C dew point	1K
R 22, R 134a, R 404A, R 507	+4°C	+38°C	1K

Valve selection for other operating conditions see page 74 or quick selection tables on page 66.

To facilitate valve dimensioning for other than the standard conditions ALCO offers an Excel based Selection Tool. This can be ordered from all Copeland sales offices or downloaded from www.emersonclimate.com/europe.

Accessories

Solder Adapter for TIS(E) with strainer

Type	Part No.	Connection, ODF	
		mm	inch
X 99980	801 046	6,0	–
X 99981	801 049	10,0	–
X 99982	801 047	–	1/4
X 99983	801 048	–	3/8



Quick Selection Tables

Published capacity data at 1 K subcooling at the inlet of the expansion valve and 1.5 bar pressure drop in the refrigeration system. For proper valve selection especially in case of high pressure drops, we recommend the use of correction factors (see page 74).

To facilitate valve dimensioning for other than the standard conditions ALCO offers an Excel based **Selection Tool**. This can be ordered from all Copeland sales offices. See www.emersonclimate.com/europe for contact addresses, email or phone

Condensing Temperature °C	R 22 Capacity kW Valve Type TI...-H....												Cage Size		
	Evaporating Temperature °C														
	+30	+20	+10	+5	0	-5	-10	-15	-20	-25	-30	-35	-40	-45	
50	0,38	0,45	0,50	0,51	0,52	0,53	0,53	0,46	0,41	0,35	0,30	0,26	0,22	0,19	TIO-00X
	0,98	1,17	1,29	1,33	1,35	1,38	1,36	1,20	1,05	0,91	0,78	0,66	0,57	0,48	TIO-000
	2,40	2,86	3,16	3,26	3,32	3,39	3,33	2,95	2,58	2,24	1,91	1,62	1,40	1,19	TIO-001
	4,03	4,78	5,29	4,47	5,56	5,67	5,57	4,95	4,32	3,75	3,20	2,72	2,35	2,00	TIO-002
	6,41	7,64	8,42	8,70	8,85	9,03	8,87	7,88	6,87	5,97	5,10	4,34	3,45	3,18	TIO-003
	10,50	12,51	13,79	14,26	14,50	14,80	14,53	12,90	11,26	9,79	8,35	7,10	6,14	5,21	TIO-004
	12,80	15,24	16,81	17,37	17,67	18,03	17,70	15,72	13,72	11,93	10,18	8,66	7,49	6,35	TIO-005
14,76	17,58	19,38	20,04	20,38	20,79	20,42	18,14	15,82	13,76	11,74	9,98	8,64	7,32	TIO-006	
40	0,24	0,37	0,44	0,46	0,48	0,50	0,49	0,44	0,39	0,34	0,29	0,25	0,22	0,18	TIO-00X
	0,61	0,95	1,14	1,20	1,25	1,29	1,27	1,15	1,01	0,88	0,75	0,64	0,56	0,47	TIO-000
	1,51	2,33	2,78	2,94	3,07	3,17	3,12	2,82	2,47	2,16	1,85	1,58	1,38	1,17	TIO-001
	2,52	3,90	4,66	4,92	5,13	5,30	5,23	4,73	4,14	3,62	3,10	2,65	2,31	1,96	TIO-002
	4,02	6,21	7,42	7,84	8,18	8,44	8,33	7,53	6,59	5,76	4,94	4,23	3,68	3,12	TIO-003
	6,59	10,17	12,16	12,85	13,39	13,83	13,65	12,33	10,79	9,44	8,10	6,92	6,03	5,12	TIO-004
	8,03	12,40	14,82	15,65	16,32	16,85	16,63	15,03	13,15	11,50	9,87	8,44	7,35	6,23	TIO-005
9,26	14,30	17,09	18,05	18,82	19,43	19,18	17,33	15,17	13,26	11,38	9,73	8,48	7,19	TIO-006	
35	0,30	0,40	0,43	0,45	0,47	0,48	0,43	0,38	0,33	0,29	0,24	0,21	0,18	TIO-00X	
	0,79	1,03	1,11	1,17	1,22	1,23	1,11	0,98	0,85	0,74	0,63	0,55	0,47	TIO-000	
	1,93	2,53	2,72	2,88	3,00	3,01	2,71	2,40	2,09	1,81	1,55	1,35	1,15	TIO-001	
	3,24	4,23	4,56	4,82	5,02	5,03	4,54	4,02	3,50	3,03	2,60	2,27	1,93	TIO-002	
	5,16	6,74	7,27	7,68	8,00	8,01	7,23	6,40	5,57	4,83	4,14	3,61	3,07	TIO-003	
	8,45	11,04	11,90	12,58	13,11	13,13	11,85	10,49	9,13	7,92	6,78	5,92	5,03	TIO-004	
	10,30	13,46	14,50	15,32	15,97	16,00	14,44	12,78	11,12	9,65	8,27	7,21	6,13	TIO-005	
11,87	15,52	16,73	17,67	18,42	18,45	16,65	14,74	12,83	11,13	9,53	8,32	7,07	TIO-006		
30	0,21	0,34	0,38	0,41	0,44	0,44	0,41	0,36	0,31	0,27	0,24	0,21	0,18	TIO-00X	
	0,55	0,89	0,99	1,07	1,13	1,15	1,05	0,93	0,81	0,70	0,61	0,53	0,46	TIO-000	
	1,35	2,19	2,44	2,63	2,78	2,81	2,57	2,29	1,99	1,72	1,50	1,31	1,12	TIO-001	
	2,26	3,67	4,09	4,41	4,66	4,71	4,30	3,83	3,33	2,88	2,52	2,20	1,88	TIO-002	
	3,59	5,84	6,51	7,02	7,42	7,50	6,84	6,10	5,30	4,59	4,01	3,51	2,99	TIO-003	
	5,89	9,56	10,66	11,50	12,16	12,28	11,21	10,00	8,68	7,51	6,57	5,75	4,90	TIO-004	
	7,18	11,65	12,99	14,02	14,81	14,97	13,66	12,18	10,58	9,16	8,01	7,01	5,98	TIO-005	
8,28	13,44	14,98	16,16	17,08	17,26	15,76	14,05	12,20	10,56	9,24	8,08	6,89	TIO-006		
25	0,28	0,33	0,38	0,40	0,41	0,38	0,34	0,30	0,26	0,23	0,20	0,17	TIO-00X		
	0,71	0,85	0,97	1,04	1,07	0,98	0,88	0,78	0,68	0,59	0,51	0,44	TIO-000		
	1,76	2,10	2,37	2,56	2,62	2,40	2,16	1,91	1,67	1,44	1,26	1,08	TIO-001		
	2,94	3,51	3,97	4,29	4,39	4,03	3,62	3,21	2,79	2,42	2,12	1,81	TIO-002		
	4,68	5,59	6,33	6,84	7,00	6,41	5,77	5,11	4,45	3,85	3,37	2,88	TIO-003		
	7,67	9,16	10,36	11,20	11,46	10,50	9,46	8,37	7,29	6,31	5,52	4,72	TIO-004		
	9,35	11,16	12,63	13,64	13,96	12,80	11,52	10,19	8,89	7,69	6,73	5,75	TIO-005		
10,79	12,88	14,57	15,74	16,11	14,76	13,29	11,76	10,25	8,87	7,76	6,64	TIO-006			
20	0,18	0,26	0,31	0,35	0,38	0,35	0,32	0,28	0,25	0,22	0,19	0,16	TIO-00X		
	0,45	0,67	0,81	0,91	0,97	0,91	0,83	0,73	0,64	0,56	0,49	0,42	TIO-000		
	1,12	1,65	2,00	2,24	2,38	2,22	2,03	1,79	1,58	1,37	1,21	1,04	TIO-001		
	1,87	2,77	3,34	3,76	3,98	3,72	3,39	3,00	2,65	2,30	2,02	1,74	TIO-002		
	2,98	4,41	5,33	5,99	6,34	5,92	5,40	4,78	4,22	3,66	3,22	2,77	TIO-003		
	4,88	7,22	8,72	9,80	10,38	9,70	8,85	7,84	6,91	6,00	5,28	4,54	TIO-004		
	5,95	8,80	10,63	11,95	12,65	11,83	10,79	9,55	8,42	7,31	6,44	5,53	TIO-005		
6,86	10,15	12,26	13,78	14,59	13,64	12,44	11,02	9,72	8,43	7,42	6,38	TIO-006			

Thermo®-Expansion Valve Series TX6

Hermetic Design

Features

- Balanced port design for constant superheat operation over a wide application range under variation of condensing pressure
- Hermetic monobloc design with solder connections for minimal leakage
- Large diaphragm eliminates disturbances to the valve and provides smoother and consistent valve control
- Tailored charges for different applications
- External equalizer
- External superheat adjustment
- PS: TX6-H/N/M/Sxx : 31bar, TX6-Zxx: 42bar
- TS: -45 ... +65°C
- No CE marking according art. 3.3 PED 97/23 EC



TX6

Standard-MOP

Refrigerant	MOP Code	MOP (bar)	Valve closed	Evaporating temperature range
R 134a	M1	3,8	+14°C	-45 to +10°C
R 22	H1	6,9	+15°C	-45 to +12°C
R 407C	N1	6,9	+17°C	-45 to +14°C
R 410A	Z1	12,1	+16°C	-45 to +14°C

Note: All temperatures are saturated/dew point. Pressures are given in gauge pressure.

Selection Charts

Nominal Capacity Q_n kW	R 134a				Connection straight through Solder/ODF
	less MOP		with Standard-MOP		
	Type	Part No.	Type	Part No.	
10,3	TX6 - M02	801 543	TX6 - M12	801 547	12 mm x 16 mm
10,3	TX6 - M02	801 541	TX6 - M12	801 545	1/2" x 5/8"
18,4	TX6 - M03	801 544	TX6 - M13	801 548	12 mm x 16 mm
18,4	TX6 - M03	801 542	TX6 - M13	801 546	1/2" x 5/8"
25,6	TX6 - M04	801 569	TX6 - M14	801 577	16 mm x 22 mm
25,6	TX6 - M04	801 565	TX6 - M14	801 573	5/8" x 7/8"
32,5	TX6 - M05	801 570	TX6 - M15	801 578	16 mm x 22 mm
32,5	TX6 - M05	801 566	TX6 - M15	801 574	5/8" x 7/8"
48,1	TX6 - M06	801 571	TX6 - M16	801 579	22 mm x 28 mm
48,1	TX6 - M06	801 567	TX6 - M16	801 575	7/8" x 1-1/8"
62,8	TX6 - M07	801 572	TX6 - M17	801 580	22 mm x 28 mm
62,8	TX6 - M07	801 568	TX6 - M17	801 576	7/8" x 1-1/8"

Nominal capacity (Q_n) is based on the following conditions:

Refrigerant	Evaporating temperature	Condensing temperature	Sub-cooling
R 407C	+4°C dew point	+38°C bubble p. +43°C dew point	1K
R 22, R 134a, R 410A	+4°C	+38°C	1K

Valve selection for other operating conditions see page 74 or use the Excel based ALCO Selection Tool. This can be ordered from all Copeland sales offices or downloaded from www.emersonclimate.com/europe.

R 407C					
Nominal Capacity Q kW	less MOP		with Standard-MOP		Connection straight through Solder/ODF
	Type	Part No.	Type	Part No.	
14,4	TX6 - N02	801 651	TX6 - N12	801 655	12 mm x 16 mm
14,4	TX6 - N02	801 653	TX6 - N12	801 534	1/2" x 5/8"
25,6	TX6 - N03	801 652	TX6 - N13	801 656	12 mm x 16 mm
25,6	TX6 - N03	801 654	TX6 - N13	801 535	1/2" x 5/8"
35,7	TX6 - N04	801 659	TX6 - N14	801 667	16 mm x 22 mm
35,7	TX6 - N04	801 663	TX6 - N14	801 536	5/8" x 7/8
45,2	TX6 - N05	801 660	TX6 - N15	801 668	16 mm x 22 mm
45,2	TX6 - N05	801 664	TX6 - N15	801 537	5/8" x 7/8
66,9	TX6 - N06	801 661	TX6 - N16	801 669	22 mm x 28 mm
66,9	TX6 - N06	801 665	TX6 - N16	801 538	7/8" x 1-1/8"
87,3	TX6 - N07	801 662	TX6 - N17	801 670	22 mm x 28 mm
87,3	TX6 - N07	801 666	TX6 - N17	801 539	7/8" x 1-1/8"

R 22					
Nominal Capacity Q kW	less MOP		with Standard-MOP		Connection straight through Solder/ODF
	Type	Part No.	Type	Part No.	
13,3	TX6 - H02	801 551	TX6 - H12	801 555	12 mm x 16 mm
13,3	TX6 - H02	801 549	TX6 - H12	801 553	1/2" x 5/8"
23,7	TX6 - H03	801 552	TX6 - H13	801 556	12 mm x 16 mm
23,7	TX6 - H03	801 550	TX6 - H13	801 554	1/2" x 5/8"
33,0	TX6 - H04	801 585	TX6 - H14	801 593	16 mm x 22 mm
33,0	TX6 - H04	801 581	TX6 - H14	801 589	5/8" x 7/8
41,8	TX6 - H05	801 586	TX6 - H15	801 594	16 mm x 22 mm
41,8	TX6 - H05	801 582	TX6 - H15	801 590	5/8" x 7/8
61,9	TX6 - H06	801 587	TX6 - H16	801 595	22 mm x 28 mm
61,9	TX6 - H06	801 583	TX6 - H16	801 591	7/8" x 1-1/8"
80,8	TX6 - H07	801 588	TX6 - H17	801 596	22 mm x 28 mm
80,8	TX6 - H07	801 584	TX6 - H17	801 592	7/8" x 1-1/8"

R 410A					
Nominal Capacity Q kW	less MOP		with Standard-MOP		Connection straight through Solder/ODF
	Type	Part No.	Type	Part No.	
16.0	-	-	TX6 - Z12	801 510	12 mm x 16 mm
16.0	-	-	TX6 - Z12	801 511	1/2" x 5/8"
28.0	-	-	TX6 - Z13	801 512	12 mm x 16 mm
28.0	-	-	TX6 - Z13	801 513	1/2" x 5/8"
40.0	-	-	TX6 - Z14	801 514	16 mm x 22 mm
40.0	-	-	TX6 - Z14	801 515	5/8" x 7/8
50.0	-	-	TX6 - Z15	801 516	16 mm x 22 mm
50.0	-	-	TX6 - Z15	801 517	5/8" x 7/8
74.0	-	-	TX6 - Z16	801 518	22 mm x 28 mm
74.0	-	-	TX6 - Z16	801 519	7/8" x 1-1/8"
97.0	-	-	TX6 - Z17	801 520	22 mm x 28 mm
97.0	-	-	TX6 - Z17	801 521	7/8" x 1-1/8"

Nominal capacity (Qn) is based on the following conditions:

Refrigerant	Evaporating temperature	Condensing temperature	Sub-cooling
R 407C	+4°C dew point	+38°C bubble p. +43°C dew point	1K
R 22, R 134a, R 410A	+4°C	+38°C	1K

Valve selection for other operating conditions see page 74 or use the Excel based ALCO Selection Tool. This can be ordered from all Copeland sales offices or downloaded from www.emersonclimate.com/europe.

Thermo®-Expansion Valve Series T

Exchangeable Power Assemblies and Orifices

Features

- Modular design for economical logistics and easy assembly and servicing
- Very good stability is attained because of the large forces generated by the large diaphragm diameter
- High quality materials and processes for high reliability and long lifetime
- Superior partial load performance due to double seat orifice design (TJRE, TERE, TIRE & THRE)
- Biflow capability for applications in heat pumps
- Capillary tube length 1.5 m (TCLE, TJRE) and 3m (TERE, TIRE & THRE)
- PS: 31 bar, TS: -45 ... +65°C
- No CE marking according art. 3.3 PED 97/23 EC



TCLE

Type Code

TCL E 100 H W 100 WL 10x16

Valve Series

External Equalizer

Capacity Code

Refrigerant Code

Charge Code

MOP Code

Flange Style

WL= Angle Style

DL = Straight through

Connection

Selection Chart for Orifices

Series	R 134a		R 22		R 404A/R 507		R 407C		Orifice
	Type	Nominal Capacity kW	Type	Nominal Capacity kW	Type	Nominal Capacity kW	Type	Nominal Capacity kW	
TCLE	25 MW	1,5	50 HW	1,9	25 SW	1,3	50 NW	2,1	X 22440-B1B
	75 MW	2,9	100 HW	3,7	75 SW	2,6	100 NW	4,0	X 22440-B2B
	150 MW	6,1	200 HW	7,9	150 SW	5,6	200 NW	8,5	X 22440-B3B
	200 MW	9,3	250 HW	11,9	200 SW	8,4	300 NW	12,9	X 22440-B3,5B
	250 MW	13,5	300 HW	17,3	250 SW	12,2	400 NW	18,7	X 22440-B4B
	350 MW	17,3	500 HW	22,2	400 SW	15,7	550 NW	24,0	X 22440-B5B
	550 MW	23,6	750 HW	30,4	600 SW	21,5	750 NW	32,9	X 22440-B6B
	750 MW	32,0	1000 HW	41,1	850 SW	29,0	1000 NW	44,4	X 22440-B7B
TJRE	11 MW	45	14 HW	58	12 SW	40	14 NW	62	X 11873-B4B
	13 MW	57	18 HW	74	14 SW	51	17 NW	80	X 11873-B5B
TERE	16 MW	71	22 HW	91	18 SW	63	21 NW	99	X 9117-B6B
	19 MW	81	26 HW	104	20 SW	72	25 NW	112	X 9117-B7B
	25 MW	112	35 HW	143	27 SW	99	33 NW	155	X 9117-B8B
	31 MW	135	45 HW	174	34 SW	120	42 NW	188	X 9117-B9B
TIRE	45 MW	174	55 HW	223	47 SW	154	52 NW	241	X 9166-B10B
THRE	55 MW	197	75 HW	253	61 SW	174	71 NW	273	X 9144-B11B
	68 MW	236	100 HW	302	77 SW	209	94 NW	327	X 9144-B13B

MOP		Evaporating Temperature Range °C				
Code	bar	R 134a	R 22	R 404A	R 407C	R 507
15	1,0	-45 .. -16				
35	2,4	-45 .. 0	-45 .. -15			
40	2,8			-45 .. -18		-45 .. -18
55	3,8	-45 .. 11		-45 .. -10		-45 .. -10
65	4,5		-45 .. 0			
75	5,2			-45 .. -2		-45 .. -2
80	5,5			-45 .. 0		-45 .. 0
100	6,9		-45 .. 13		-45 .. 14	

Nominal capacity (Qn) is based on the following conditions:

Refrigerant	Evaporating temperature	Condensing temperature	Sub-cooling
R 407C	+4°C dew point	+38°C bubble p. +43°C dew point	1K
R 22, R 134a, R 404A/R 507	+4°C	+38°C	1K

Valve selection for other operating conditions see page 74 or use the Excel based ALCO Selection Tool. This can be ordered from all Copeland sales offices or downloaded from www.emersonclimate.com/europe.

Available upon special request:

- Power assembly with solder connection for external pressure equalization
- Non-standard MOPs
- Non-standard charges
- Non-standard connection sizes, see page 86

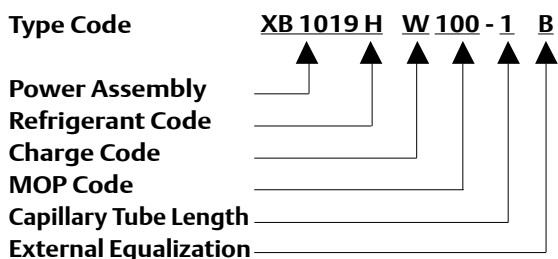

Selection Chart for Power Assemblies and Recommended Flanges

	Orifice	Connection		Power Assembly
		Standard-Flange, Angle Solder/ODF		
		mm	inch	
	X 22440-B1B	C 501 - 5 mm 10 x 16	C 501 - 5 3/8 x 5/8	XB1019...1B
	X 22440-B2B			
	X 22440-B3B			
	X 22440-B3,5B			
	X 22440-B4B			
	X 22440-B5B	C 501 - 7 mm 12 x 16	C 501 - 7 1/2 x 5/8	
	X 22440-B6B			
	X 22440-B7B	A 576 mm 16 x 22 (22 x 28 ODM)	A 576 5/8 x 7/8 (7/8 x 1 1/8 ODM)	
	X 22440-B8B			
	X 11873-B4B			
	X 11873-B5B			
	X 9117-B6B	9153 22 x 22	9153 7/8 x 7/8 (1 1/8 x 1 1/8 ODM)	XC726...2B
	X 9117-B7B			
	X 9117-B8B			
	X 9117-B9B			
	X 9166-B10B			
	X 9144-B11B	9149 22 x 22	9149 7/8 x 7/8 (1 1/8 x 1 1/8 ODM)	
	X 9144-B13B			

Accessories

	Type	Part No.
Gasket Set for T Series Valves	X 13455 -1	027 579
Service Tool for T Series	X 99999	800 005
Steel screws for following flange types: C501 , 9761 , 6346 , A576 9148 , 9149, 9152, 9153, 10331 , 10332	Screw ST 32 Screw ST 48	803 573 803 574



Correction Tables for Thermo®-Expansion Valves Series TI, TX6, T and L

Valve selection for operating conditions other than nominal conditions:

Alternatively download the Excel based ALCO Selection Tool from www.emersonclimate.com/europe.

$$Q_n = Q_o \times K_t \times K_{\Delta p}$$

Q_n : Nominal valve capacity

K_t : Correction factor for evaporating and liquid temperature

Q_o : Required cooling capacity

$K_{\Delta p}$: Correction factor for pressure drop at valve

Liquid Temperature entering Valve °C	Correction Factor K_t															
	R 410A (TX6 only)															
	Evaporating Temperature °C															
	+20	+15	+10	+5	0	-5	-10	-15	-20	-25	-30	-35	-40	-45		
+65	1,75	1,76	1,78	1,80	1,83	1,86	1,89	2,18	2,55	3,05	3,69	4,49	5,46	6,62		
+60	1,49	1,50	1,51	1,53	1,54	1,57	1,59	1,83	2,14	2,55	3,08	3,73	4,52	5,45		
+55	1,31	1,32	1,33	1,35	1,36	1,38	1,40	1,61	1,87	2,23	2,68	3,25	3,92	4,72		
+50	1,19	1,20	1,20	1,21	1,23	1,24	1,26	1,44	1,68	2,00	2,40	2,90	3,49	4,20		
+45	1,09	1,09	1,10	1,11	1,12	1,13	1,15	1,32	1,53	1,82	2,18	2,63	3,17	3,80		
+40	1,01	1,01	1,02	1,03	1,04	1,05	1,06	1,21	1,41	1,67	2,01	2,41	2,90	3,48		
+35	0,94	0,94	0,95	0,96	0,97	0,98	0,99	1,13	1,31	1,55	1,86	2,24	2,69	3,21		
+30	0,88	0,89	0,89	0,90	0,91	0,91	0,92	1,06	1,22	1,45	1,74	2,09	2,50	2,99		
+25	0,83	0,84	0,84	0,85	0,85	0,86	0,87	0,99	1,15	1,36	1,63	1,96	2,35	2,80		
+20		0,79	0,80	0,80	0,81	0,81	0,82	0,94	1,09	1,29	1,54	1,84	2,21	2,64		
Correction Factor $K_{\Delta p}$																
Δp (bar)	1	2	3	4	5	6	7	8	9	10	11	12	13	14	15	16
$K_{\Delta p}$	3,74	2,65	2,16	1,87	1,67	1,53	1,41	1,32	1,25	1,18	1,13	1,08	1,04	1	0,97	0,94
Δp (bar)	17	18	19	20	21	22	23	24	25	26	27	28	29	30	31	32
$K_{\Delta p}$	0,91	0,88	0,86	0,84	0,82	0,8	0,78	0,76	0,75	0,73	0,72	0,71	0,69	0,68	0,67	0,66

Liquid Temperature entering Valve °C	Correction Factor K_t															
	R 134a															
	Evaporating Temperature °C															
	+30	+25	+20	+15	+10	+5	0	-5	-10	-15	-20	-25	-30			
+60	1,22	1,25	1,27	1,30	1,33	1,36	1,40	1,44	1,48	1,75	2,08	2,46	2,94			
+55	1,14	1,16	1,18	1,21	1,23	1,26	1,29	1,33	1,36	1,60	1,90	2,25	2,68			
+50	1,07	1,08	1,10	1,13	1,15	1,17	1,20	1,23	1,26	1,48	1,76	2,07	2,46			
+45	1,00	1,02	1,04	1,06	1,08	1,10	1,12	1,15	1,17	1,38	1,63	1,92	2,28			
+40	0,93	0,96	0,98	0,99	1,01	1,03	1,05	1,08	1,10	1,29	1,52	1,79	2,12			
+35	0,90	0,91	0,92	0,94	0,96	0,97	0,99	1,01	1,03	1,21	1,43	1,68	1,99			
+30	0,85	0,86	0,88	0,89	0,91	0,92	0,94	0,96	0,98	1,14	1,35	1,58	1,87			
+25		0,82	0,83	0,85	0,86	0,87	0,89	0,91	0,92	1,08	1,27	1,49	1,76			
+20			0,80	0,81	0,82	0,83	0,85	0,89	0,88	1,02	1,21	1,41	1,67			
+15				0,77	0,78	0,79	0,81	0,82	0,84	0,97	1,15	1,34	1,58			
+10					0,75	0,76	0,77	0,78	0,80	0,93	1,09	1,28	1,51			
+5						0,73	0,74	0,75	0,76	0,89	1,04	1,22	1,44			
0							0,71	0,72	0,73	0,85	1,00	1,17	1,37			
-5								0,69	0,70	0,82	0,96	1,12	1,31			
-10									0,68	0,79	0,92	1,07	1,26			
Correction Factor $K_{\Delta p}$																
Δp (bar)	0,5	1,0	1,5	2,0	2,5	3,0	3,5	4,0	4,5	5,0	5,5	6,0	6,5	7,0	7,5	8,0
$K_{\Delta p}$	3,50	2,48	2,02	1,75	1,57	1,43	1,32	1,24	1,17	1,11	1,06	1,01	0,97	0,94	0,90	0,88
Δp (bar)	8,5	9,0	9,5	10,0	10,5	11,0	11,5	12,0	13,0	14,0	15,0	16,0	17,0	18,0	19,0	20,0
$K_{\Delta p}$	0,85	0,83	0,80	0,78	0,76	0,75	0,73	0,72	0,69	0,66	0,64	0,62	0,60	0,58	0,57	0,55

In cases of subcooling of more than 15K please use additionally the correction factors on page 62 of this brochure.

Liquid Temperature entering Valve °C	R 22															
	Correction Factor K_t															
	Evaporating Temperature °C															
	+30	+25	+20	+15	+10	+5	0	-5	-10	-15	-20	-25	-30	-35	-40	-45
+60	1,22	1,23	1,24	1,25	1,26	1,28	1,30	1,31	1,38	1,58	1,84	2,16	2,56	3,04	3,55	4,23
+55	1,14	1,15	1,16	1,17	1,19	1,20	1,22	1,23	1,29	1,42	1,72	2,02	2,39	2,83	3,30	3,94
+50	1,08	1,09	1,10	1,11	1,12	1,13	1,15	1,16	1,21	1,39	1,62	1,89	2,24	2,66	3,10	3,68
+45	1,02	1,03	1,04	1,05	1,06	1,07	1,08	1,10	1,15	1,31	1,52	1,79	2,11	2,50	2,91	3,46
+40	0,97	0,98	0,99	1,00	1,01	1,02	1,03	1,04	1,09	1,24	1,45	1,69	2,00	2,37	2,75	3,27
+35	0,92	0,93	0,94	0,95	0,96	0,97	0,98	0,99	1,03	1,18	1,37	1,61	1,89	2,24	2,60	3,09
+30	0,88	0,89	0,90	0,91	0,92	0,93	0,94	0,95	0,99	1,13	1,31	1,55	1,83	2,13	2,47	2,93
+25		0,85	0,86	0,87	0,88	0,89	0,89	0,90	0,94	1,08	1,25	1,46	1,72	2,03	2,36	2,80
+20			0,83	0,83	0,84	0,85	0,86	0,87	0,90	1,03	1,19	1,40	1,64	1,94	2,25	2,66
+15				0,80	0,81	0,81	0,82	0,83	0,87	0,99	1,14	1,34	1,57	1,86	2,15	2,55
+10					0,78	0,78	0,79	0,80	0,83	0,95	1,10	1,28	1,51	1,78	2,06	2,44
+5						0,75	0,76	0,77	0,80	0,91	1,06	1,23	1,45	1,71	1,98	2,34
0							0,73	0,74	0,77	0,88	1,02	1,19	1,39	1,65	1,90	2,25
-5								0,71	0,74	0,85	0,98	1,14	1,34	1,58	1,83	2,17
-10									0,72	0,82	0,95	1,10	1,30	1,53	1,77	2,09
Correction Factor $K_{\Delta p}$																
Δp (bar)	0,5	1,0	1,5	2,0	2,5	3,0	3,5	4,0	4,5	5,0	5,5	6,0	6,5	7,0	8,0	9,0
$K_{\Delta p}$	4,25	3,00	2,46	2,13	1,90	1,74	1,61	1,50	1,42	1,35	1,28	1,23	1,18	1,14	1,06	1,00
Δp (bar)	10,0	11,0	12,0	13,0	14,0	15,0	16,0	17,0	18,0	19,0	20,0	21,0	22,0	23,0	24,0	25,0
$K_{\Delta p}$	0,95	0,91	0,87	0,83	0,80	0,78	0,75	0,73	0,71	0,69	0,67	0,66	0,64	0,63	0,61	0,60

Liquid Temperature entering Valve °C	R 404A															
	Correction Factor K_t															
	Evaporating Temperature °C															
	+30	+25	+20	+15	+10	+5	0	-5	-10	-15	-20	-25	-30	-35	-40	-45
+60	1,56	1,59	1,64	1,69	1,74	1,81	1,88	1,96	2,06	2,43	2,95	3,56	4,37	5,38	6,71	8,47
+55	1,32	1,35	1,38	1,42	1,46	1,50	1,55	1,61	1,68	1,96	2,36	2,83	3,43	4,16	5,12	6,34
+50	1,16	1,18	1,20	1,23	1,26	1,30	1,34	1,38	1,43	1,67	1,99	2,37	2,85	3,43	4,18	5,14
+45	1,04	1,05	1,07	1,10	1,12	1,15	1,18	1,22	1,26	1,46	1,74	2,05	2,46	2,95	3,57	4,35
+40	0,94	0,96	0,97	0,99	1,02	1,04	1,07	1,09	1,13	1,30	1,55	1,82	2,17	2,59	3,13	3,80
+35	0,87	0,88	0,90	0,91	0,93	0,95	0,97	1,00	1,02	1,18	1,40	1,64	1,96	2,33	2,80	3,38
+30	0,81	0,82	0,83	0,84	0,86	0,88	0,90	0,92	0,94	1,08	1,28	1,50	1,78	2,11	2,53	3,05
+25		0,76	0,77	0,79	0,80	0,82	0,83	0,85	0,87	1,00	1,18	1,39	1,64	1,94	2,32	2,79
+20			0,73	0,74	0,75	0,77	0,78	0,80	0,81	0,94	1,10	1,29	1,52	1,80	2,15	2,58
+15				0,70	0,71	0,72	0,73	0,75	0,76	0,88	1,03	1,21	1,42	1,68	2,00	2,40
+10					0,67	0,68	0,69	0,71	0,72	0,83	0,97	1,13	1,34	1,58	1,88	2,25
+5						0,65	0,66	0,67	0,68	0,78	0,92	1,07	1,26	1,49	1,77	2,11
0							0,63	0,64	0,65	0,75	0,88	1,02	1,20	1,41	1,67	2,00
-5								0,61	0,62	0,71	0,83	0,97	1,14	1,34	1,59	1,90
-10									0,60	0,68	0,80	0,93	1,09	1,28	1,52	1,81
Correction Factor $K_{\Delta p}$																
Δp (bar)	0,5	1,0	1,5	2,0	2,5	3,0	3,5	4,0	4,5	5,0	5,5	6,0	6,5	7,0	8,0	9,0
$K_{\Delta p}$	4,55	3,21	2,62	2,27	2,03	1,86	1,72	1,61	1,52	1,44	1,37	1,31	1,26	1,21	1,14	1,07
Δp (bar)	10,0	11,0	12,0	13,0	14,0	15,0	16,0	17,0	18,0	19,0	20,0	21,0	22,0	23,0	24,0	25,0
$K_{\Delta p}$	1,02	0,97	0,93	0,89	0,86	0,83	0,80	0,78	0,76	0,74	0,72	0,70	0,69	0,67	0,66	0,64

In cases of subcooling of more than 15K please use additionally the correction factors on page 62 of this brochure.

Liquid Temperature entering Valve °C	R 407C											
	Correction Factor K_t Evaporating Temperature											
	+30	+25	+20	+15	+10	+5	0	-5	-10	-15	-20	-25
+55	1,20	1,21	1,23	1,26	1,28	1,31	1,34	1,37	1,40	1,63	1,98	2,42
+50	1,10	1,11	1,13	1,15	1,17	1,19	1,22	1,24	1,27	1,48	1,79	2,18
+45	1,02	1,03	1,05	1,06	1,08	1,10	1,12	1,14	1,17	1,35	1,64	2,00
+40	0,95	0,96	0,98	0,99	1,01	1,02	1,04	1,06	1,08	1,25	1,52	1,84
+35	0,89	0,90	0,92	0,93	0,94	0,96	0,98	0,99	1,01	1,17	1,41	1,71
+30	0,85	0,85	0,87	0,88	0,89	0,90	0,92	0,93	0,95	1,10	1,32	1,60
+25		0,81	0,82	0,83	0,84	0,85	0,87	0,88	0,90	1,03	1,25	1,51
+20			0,78	0,79	0,80	0,81	0,82	0,84	0,85	0,98	1,18	1,43
+15				0,75	0,76	0,77	0,78	0,80	0,81	0,93	1,12	1,35
+10					0,73	0,74	0,75	0,76	0,77	0,89	1,07	1,29
+5						0,71	0,72	0,73	0,74	0,85	1,02	1,23
0							0,69	0,70	0,71	0,81	0,98	1,18
-5								0,67	0,68	0,78	0,94	1,13
-10									0,65	0,75	0,90	1,08

Correction Factor $K_{\Delta p}$																
Δp (bar)	0,5	1,0	1,5	2,0	2,5	3,0	3,5	4,0	4,5	5,0	5,5	6,0	6,5	7,0	8,0	9,0
$K_{\Delta p}$	4,78	3,33	2,72	2,36	2,11	1,92	1,78	1,67	1,57	1,49	1,42	1,36	1,31	1,26	1,18	1,11
Δp (bar)	10,0	11,0	12,0	13,0	14,0	15,0	16,0	17,0	18,0	19,0	20,0	21,0	22,0	23,0	24,0	25,0
$K_{\Delta p}$	1,05	1,01	0,96	0,92	0,89	0,86	0,83	0,81	0,79	0,76	0,75	0,73	0,71	0,70	0,68	0,67

Liquid Temperature entering Valve °C	R 507															
	Correction Factor K_t Evaporating Temperature															
	+30	+25	+20	+15	+10	+5	0	-5	-10	-15	-20	-25	-30	-35	-40	-45
+60	1,54	1,57	1,61	1,65	1,71	1,76	1,83	1,90	1,98	2,36	2,84	3,44	4,23	5,25	6,61	8,45
+55	1,30	1,33	1,36	1,39	1,43	1,47	1,52	1,57	1,62	1,92	2,29	2,75	3,35	4,11	5,11	6,44
+50	1,15	1,17	1,19	1,22	1,24	1,28	1,31	1,35	1,40	1,64	1,95	2,33	2,81	3,43	4,23	5,29
+45	1,03	1,05	1,07	1,09	1,11	1,14	1,17	1,20	1,23	1,45	1,71	2,04	2,45	2,97	3,64	4,53
+40	0,94	0,96	0,97	0,99	1,01	1,03	1,06	1,08	1,11	1,30	1,53	1,82	2,18	2,63	3,22	3,98
+35	0,87	0,88	0,90	0,91	0,93	0,95	0,97	0,99	1,01	1,18	1,39	1,65	1,97	2,37	2,89	3,56
+30	0,81	0,82	0,83	0,85	0,86	0,88	0,89	0,91	0,93	1,09	1,28	1,51	1,80	2,17	2,63	3,23
+25		0,77	0,78	0,79	0,80	0,82	0,83	0,85	0,87	1,01	1,18	1,40	1,66	1,99	2,42	2,97
+20			0,73	0,74	0,75	0,77	0,78	0,79	0,81	0,94	1,10	1,30	1,54	1,85	2,24	2,74
+15				0,70	0,71	0,72	0,73	0,75	0,76	0,88	1,03	1,21	1,44	1,73	2,09	2,55
+10					0,67	0,68	0,69	0,70	0,72	0,83	0,97	1,14	1,35	1,62	1,95	2,38
+5						0,64	0,65	0,67	0,68	0,78	0,92	1,07	1,27	1,52	1,83	2,23
0							0,62	0,63	0,64	0,74	0,87	1,02	1,20	1,43	1,73	2,10
-5								0,60	0,61	0,70	0,82	0,96	1,14	1,35	1,63	1,98
-10									0,58	0,67	0,78	0,91	1,08	1,28	1,54	1,87

Correction Faktor $K_{\Delta p}$																
Δp (bar)	0,5	1,0	1,5	2,0	2,5	3,0	3,5	4,0	4,5	5,0	5,5	6,0	6,5	7,0	8,0	9,0
$K_{\Delta p}$	4,63	3,27	2,67	2,31	2,07	1,89	1,75	1,64	1,54	1,46	1,40	1,34	1,28	1,24	1,16	1,09
Δp (bar)	10,0	11,0	12,0	13,0	14,0	15,0	16,0	17,0	18,0	19,0	20,0	21,0	22,0	23,0	24,0	25,0
$K_{\Delta p}$	1,03	0,99	0,94	0,91	0,87	0,85	0,82	0,79	0,77	0,75	0,73	0,71	0,70	0,68	0,67	0,65

In cases of subcooling of more than 15K please use additionally the correction factors on page 62 of this brochure.

Thermo®-Expansion Valve Series ZZ

for Low Evaporating Temperatures between -45 and -120°C

Features

- Modular design for economical logistics and easy assembly and servicing
- Very good stability is attained because of the large forces generated by the large diaphragm diameter
- High quality materials and processes for high reliability and long lifetime
- Capillary tube length 3 m
- PS: 31 bar, TS: -120 ... +65°C
- No CE marking according art. 3.3 PED 97/23 EC



ZZCE

Type Code **ZZC E 1 1/2 H W 35 WL 10x16**

Valve Series
 External Equalizer
 Capacity Code
 Refrigerant Code
 Charge Code
 MOP Code
 Flange Style
 WL=Angle Style
 DL=Straight through
 Connection

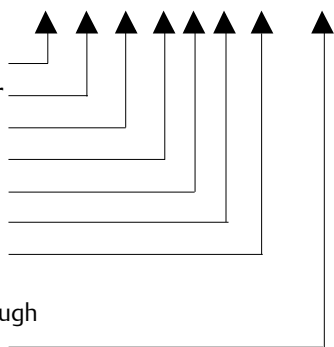

XC 726 H W 35 - 2 B

Power Assembly
 Refrigerant Code
 Charge Code
 MOP Code
 Capillary Tube Length
 External Equalization

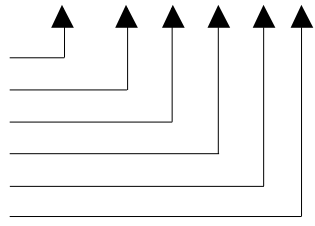

Available upon special request:

- Power assembly with solder connection for external pressure equalization
- Non-standard MOPs
- Non-standard charges
- Non-standard connection sizes (Selection see page 86)

Series	R 22		R 23		R 404A / R 507		Orifice	Connection		Power Assembly
	Type	Nom. Cap. kW	Type	Nom. Cap. kW	Type	Nom. Cap. kW		Standard Flange, Angle Solder/ODF mm	Zoll	
ZZCE	3/4 HW	1,8	2 BG	1,9	3/4 SW	1,2	X 10-B01	C 501 - 5 mm 10 x 16	C 501 - 5 3/8" x 5/8"	XC726... ...2B
	1 1/2 HW	3,8	6 BG	4,0	1 1/2 SW	2,6	X 10-B02			
	2 1/2 HW	6,4	8 BG	6,8	2 1/2 SW	4,4	X 10-B03			
	4 HW	10,2	12 BG	10,8	3 1/2 SW	7,0	X 10-B04	C 501 - 7 mm 12 x 16	C 501 - 7 1/2" x 5/8"	
	6 HW	15,4	17 BG	16,3	5 SW	10,6	X 10-B05			
	8 HW	20,5	25 BG	21,7	8 SW	14,1	X 10-B06	A 576 mm 16 X 22 (22 x 28 ODM)	A 576 5/8" x 7/8" (7/8" x 1 1/8" ODM)	
	10 HW	25,6	31 BG	27,1	9 SW	17,6	X 10-B07			

Attention: To withstand stress at extremely low temperatures, thermo expansion valves series ZZ feature bronze bolts.

Nominal capacity is based on the following conditions:

Refrigerant	Evaporating temperature	Condensing temperature	Sub-cooling
R 22, R 23, R 404A, R 507	+4°C	+38°C	1K

Valve selection at other operating conditions see page 78.

Preferred MOPs

MOP Code	MOP		Evaporating Temperature Range (°C)		
	bar	T _{max}	R 22	R 23	R 404A / R 507
20	1,4	-66°C		-100 .. -71	
35	2,4	-11°C	-70 .. -15		
40	2,8	-14°C			-75 .. -18
55	3,8	-7°C			-75 .. -10
60	4,1	-48°C		-100 .. -51	
125	8,6	-32°C		-100 .. -33	

Accessories

	Type	Part No.
Gasket Set for ZZ Series Valves	X 13455 -1	027 579
Service Tool for ZZ Series	X 99999	800 005
Bronze screws for following flange types (ZZ-Valves): C501 , 9761 , 6346 , A576 9152, 9153, 10331 , 10332	Screw BZ 32 Screw BZ 48	803 575 803 576

Correction Tables for Series ZZ

Valve selection for operating conditions other than specified on page 77:

$$Q_n = Q_o \times K_t \times K_{\Delta p}$$

Q_n : Nominal valve capacity
 Q_o : Required cooling capacity
 K_t : Correction factor for evaporating and liquid temperature
 $K_{\Delta p}$: Correction factor for pressure drop at valve

Liquid Temperature entering valve °C	Correction Factor K_t											
	Evaporating Temperature °C											
	-45	-50	-55	-60	-65	-70						
+10	1,02	1,21	1,42	1,66	1,97	2,30						
0	0,94	1,12	1,30	1,53	1,75	2,02						
-10	0,88	1,04	1,21	1,42	1,61	1,83						
-20	0,82	0,98	1,13	1,32	1,50	1,71						
-30	0,77	0,92	1,05	1,23	1,39	1,56						
-40		0,86	1,00	1,15	1,30	1,47						
-50				1,09	1,25	1,42						
Correction Factor $K_{\Delta p}$												
Δp (bar)	0,5	1,0	1,5	2,0	2,5	3,0	3,5	4,0	4,5	5,0	6,0	7,0
$K_{\Delta p}$	4,40	3,10	2,50	2,20	2,00	1,80	1,70	1,60	1,50	1,40	1,30	1,20
Δp (bar)	8,0	9,0	10,0	11,0	12,0	13,0	14,0	15,0	16,0	17,0	18,0	19,0
$K_{\Delta p}$	1,10	1,04	0,98	0,94	0,90	0,87	0,83	0,81	0,78	0,76	0,74	0,72

For the proper sizing of thermo expansion valves in cases of sub-cooling of more than 15K please use additionally the correction factors on page 62 of this brochure.

Liquid Temperature entering valve °C	Correction Factor K_t											
	Evaporating Temperature °C											
	-45	-50	-55	-60	-65	-70	-75	-80	-85	-90	-95	-100
-10	1,18	1,18	1,19	1,21	1,28	1,48	1,86	2,21	2,73	3,36	4,15	5,06
-15	1,11	1,11	1,12	1,13	1,20	1,39	1,74	2,07	2,56	3,14	3,88	4,72
-20	1,04	1,05	1,06	1,07	1,13	1,31	1,64	1,95	2,41	2,95	3,64	4,43
-25	0,99	0,99	1,00	1,01	1,07	1,24	1,55	1,84	2,27	2,78	3,43	4,17
-30	0,94	0,94	0,95	0,96	1,02	1,17	1,47	1,75	2,15	2,63	3,24	3,94
-35	0,89	0,90	0,91	0,91	0,97	1,12	1,40	1,66	2,04	2,50	3,08	3,74
-40	0,85	0,86	0,86	0,87	0,92	1,06	1,33	1,58	1,94	2,38	2,92	3,55
-45		0,82	0,83	0,83	0,88	1,02	1,27	1,51	1,85	2,27	2,79	3,38
-50			0,79	0,80	0,84	0,97	1,22	1,44	1,77	2,17	2,86	3,23
-55				0,76	0,81	0,93	1,17	1,38	1,70	2,07	2,55	3,09
-60					0,78	0,90	1,12	1,33	1,63	1,99	2,44	2,96
-65						0,86	1,08	1,27	1,57	1,91	2,35	2,84
-70							1,04	1,23	1,51	1,84	2,26	2,73
-75								1,18	1,45	1,77	2,18	2,63
-80									1,40	1,71	2,10	2,54
Correction Factor $K_{\Delta p}$												
Δp (bar)	0,5	1,0	1,5	2,0	2,5	3,0	3,5	4,0	4,5	5,0	6,0	7,0
$K_{\Delta p}$	4,20	2,97	2,43	2,10	1,88	1,72	1,59	1,49	1,40	1,33	1,21	1,12
Δp (bar)	8,0	9,0	10,0	11,0	12,0	13,0	14,0	15,0	16,0	17,0	18,0	19,0
$K_{\Delta p}$	1,05	0,99	0,94	0,90	0,86	0,82	0,79	0,77	0,74	0,72	0,70	0,68

Liquid Temperature entering valve °C	R 404A							
	Correction Factor K_t							
	Evaporating Temperature °C							
	-40	-45	-50	-55	-60	-65	-70	-75
+40	1,40	1,76	2,21	2,77	3,56	4,30	4,87	5,61
+35	1,24	1,55	1,94	2,42	3,09	3,71	4,17	4,77
+30	1,12	1,39	1,73	2,15	2,74	3,27	3,66	4,17
+25	1,02	1,26	1,57	1,94	2,46	2,93	3,27	3,70
+20	0,94	1,16	1,44	1,77	2,24	1,66	2,96	3,34
+15	0,87	1,07	1,33	1,63	2,06	2,44	2,71	3,05
+10	0,81	1,00	1,23	1,52	1,91	2,26	2,49	2,80
+5	0,76	0,94	1,15	1,42	1,78	2,10	2,32	2,60
0	0,71	0,88	1,08	1,33	1,67	1,97	2,17	2,43
-5	0,68	0,83	1,02	1,25	1,57	1,85	2,04	2,28
-10	0,64	0,79	0,97	1,19	1,49	1,75	1,92	2,14
-15	0,61	0,75	0,92	1,13	1,41	1,66	1,82	2,03
-20	0,58	0,72	0,88	1,07	1,34	1,57	1,73	1,92
-25	0,56	0,69	0,84	1,03	1,28	1,50	1,65	1,83
-30	0,54	0,66	0,80	0,98	1,22	1,43	1,57	1,75
-35	0,51	0,63	0,77	0,94	1,17	1,36	1,49	1,66
-40		0,60	0,74	0,90	1,12	1,31	1,43	1,59
-45			0,71	0,86	1,07	1,25	1,37	1,52
-50				0,83	1,03	1,21	1,32	1,46

Correction Factor $K_{\Delta p}$												
Δp (bar)	0,5	1	1,5	2	2,5	3	3,5	4	4,5	5	6	7
$K_{\Delta p}$	4,73	3,34	2,73	2,36	2,11	1,93	1,79	1,67	1,58	1,5	1,37	1,26
Δp (bar)	8	9	10	11	12	13	14	15	16	17	18	19
$K_{\Delta p}$	1,18	1,11	1,06	1,01	0,97	0,93	0,89	0,86	0,84	0,8	0,79	0,77

For the proper sizing of thermo expansion valves in cases of sub-cooling of more than 15K please use additionally the correction factors on page 62 of this brochure.

Liquid Temperature entering valve °C	R 507					
	Correction Factor K_t					
	Evaporating Temperature °C					
	-45	-50	-55	-60	-65	-70
+30	1,26	1,67	2,10	2,68	3,48	4,58
+20	1,07	1,41	1,77	2,25	2,89	3,78
+10	0,94	1,22	1,52	1,92	2,46	3,23
0	0,83	1,08	1,33	1,68	2,16	2,82
-10	0,75	0,95	1,19	1,49	1,92	2,48
-20	0,67	0,86	1,07	1,34	1,70	2,20
-30	0,61	0,78	0,96	1,21	1,54	2,00
-40	0,55	0,71	0,86	1,08	1,38	1,79
-50			0,79	0,99	1,24	1,62

Correction Factor $K_{\Delta p}$												
Δp (bar)	0,5	1,0	1,5	2,0	2,5	3,0	3,5	4,0	4,5	5,0	6,0	7,0
$K_{\Delta p}$	4,77	3,37	2,75	2,38	2,13	1,95	1,80	1,69	1,59	1,51	1,38	1,27
Δp (bar)	8,0	9,0	10,0	11,0	12,0	13,0	14,0	15,0	16,0	17,0	18,0	19,0
$K_{\Delta p}$	1,19	1,12	1,07	1,02	0,97	0,94	0,90	0,87	0,84	0,82	0,79	0,77

For the proper sizing of thermo expansion valves in cases of sub-cooling of more than 15K please use additionally the correction factors on page 62 of this brochure.

Liquid Injection Valve Series L

Exchangeable Power Assemblies and Orifices

Features

- Applications for Series L valves include super-heat control (desuperheating of suction gas i.e. in hotgas bypass systems and interstage cooling in multiple stage compressors)
- Modular design for economical logistics and easy assembly and servicing
- Very good stability is attained because of the large forces generated by the large diaphragm diameter
- High quality materials and processes for high reliability and long lifetime
- Superior partial load performance due to seat orifice design (LJRE, LERE & LIRE)
- Capillary tube length 3 m
- PS: 31 bar, TS: -45 ... +65°C
- No CE marking according art. 3.3 PED 97/23 EC



LCLE

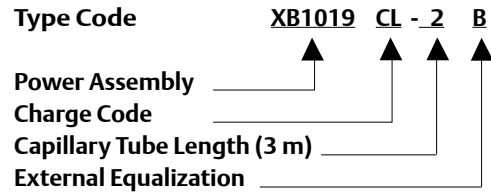
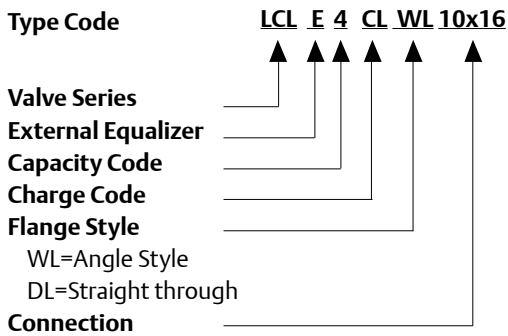

Series	Nominal Capacity Q _n kW					Orifice	Connections Standard Flange, Angle Solder/ODF		Power Assembly
	R 134a	R 22	R 404A	R 407C	R 507		mm	inch	
LCLE	1 *	1,5	1,9	1,3	2,1	1,3	C 501 – 5 mm 10 x 16	C 501 – 5 3/8 x 5/8	XB1019...2B
	2 *	2,9	3,7	2,6	4,0	2,6			
	3 *	6,1	7,9	5,6	8,5	5,6			
	3,5 *	9,3	11,9	8,4	12,9	8,4			
	4 *	13,5	17,3	12,2	18,7	12,2	C 501 – 7 mm 12 x 16	C 501 – 7 1/2 x 5/8	
	6 *	17,3	22,2	15,7	24,0	15,7			
	7 *	23,6	30,4	21,5	32,9	21,5	A 576 mm 16 x 22 (22 x 28 ODM)	A 576 5/8 x 7/8 (7/8 x 1 1/8 ODM)	
	9 *	32,0	41,1	29,0	44,4	29,0			
	10 *	37,2	47,8	33,8	51,7	33,8			
	11 *	45	58	40	62	40			
LJRE	12 *	57	74	51	80	51	10331 22 x 22	10331 7/8 x 7/8 (1 1/8 x 1 1/8 ODM)	
	13 *	71	91	63	99	63	9153 22 x 22	9153 7/8 x 7/8 (1 1/8 x 1 1/8 ODM)	
LERE	14 *	81	104	72	112	72			
	15 *	112	143	99	155	99			
	16 *	135	174	120	188	120			
LIRE	17 *	174	223	154	241	154	X 9166-B10B	X 9166-B10B	XC726...2B

Superheat selection

* Charge Code	Refrigerant				
	R 134a	R 22	R 404A	R 407C	R 507
CL	–	15 K	22 K	13 K	22 K
GL	15 K	30 K	35 K	25 K	35 K
UL	30 K	45 K		40 K	

* Please indicate designation character for desired superheat

Nominal capacity (Q_n) is based on the following conditions:

Refrigerant	Evaporating temperature	Condensing temperature	Sub-cooling
R 407C	+4°C dew point	+38°C bubble p. +43°C dew point	1K
R 22, R 134a, R 404A, R 507	+4°C	+38°C	1K

Valve selection at other operating conditions see page 74.

Available upon special request

- Power assembly with solder connection for external pressure equalization
- Non-standard connection sizes see page 86.

Accessories

	Type	Part No.
Gasket Set for L Series Valves	X 13455 -1	027 579
Service Tool for L Series	X 99999	800 005
Steel screws for following flange types: C501 , 9761 , 6346 , A576 9152, 9153, 10331 , 10332	Screw ST 32 Screw ST 48	803 573 803 574

Correction Tables for Series L

Valve selection for desuperheating of suction gas:

The required desuperheating capacity Q_{des} has to be multiplied with the correction factors on page 74.

$$Q_{des} \times K_t \times K_{\Delta p} = Q_n$$

- Q_{des} : Required desuperheating capacity
- K_t : Correction factor for evaporating and liquid temperature
- $K_{\Delta p}$: Correction factor for pressure drop at valve
- Q_n : Nominal valve capacity

Valve selection for desuperheating of suction gas in conjunction with hotgas-bypass regulation:

The required bypass capacity Q_{Byp} has to be multiplied with correction factor K_{ti} per table below.

$$Q_{Byp} \times K_{ti} = Q_n$$

- Q_{Byp} : Required bypass capacity
- K_{ti} : Correction factor for evaporating temperature
- Q_n : Nominal valve capacity

Condensing Temperature Bubble point °C	Refrigerant	Correction Factor K_{ti}							
		Evaporating Temperature °C							
		+10	+5	0	-10	-20	-30	-40	-50
+50 (R 407C: +54 dew point)	R 22	0,33	0,36	0,40	0,47	0,56	0,66	0,78	0,93
	R 407 C	0,41	0,45	0,49	0,58	0,69			
	R 134a	0,38	0,42	0,44	0,54	0,64			
	R 507 / R 404A	0,50	0,54	0,59	0,70	0,83	0,98	1,18	1,38
+40 (R 407C: +45 dew point)	R 22	0,26	0,29	0,32	0,38	0,46	0,55	0,66	0,78
	R 407 C	0,32	0,35	0,39	0,46	0,55			
	R 134a	0,31	0,33	0,36	0,44	0,52			
	R 507 / R 404A	0,38	0,42	0,45	0,54	0,64	0,76	0,90	1,08
+30 (R 407C: +35 dew point)	R 22	0,20	0,22	0,25	0,31	0,38	0,46	0,55	0,66
	R 407 C	0,25	0,28	0,31	0,37	0,45			
	R 134a	0,24	0,26	0,29	0,35	0,43			
	R 507 / R 404A	0,29	0,32	0,35	0,42	0,51	0,60	0,72	0,86
+20 (R 407C: +26 dew point)	R 22	0,15	0,17	0,19	0,25	0,31	0,38	0,46	0,56
	R 407 C	0,19	0,21	0,24	0,30	0,37			
	R 134a	0,18	0,20	0,22	0,28	0,35			
	R 507 / R 404A	0,22	0,25	0,27	0,33	0,40	0,48	0,58	0,70

Correction factors based on 20K superheat suction gas at the inlet of compressor, discharge temperature 28K above isentropic compression and 1K subcooling.

Liquid Injection Valves Series 935

Exchangeable Power Assemblies and Orifices

Applications

- Series 935 valves are applied as temperature controls. Applications include:
 - Desuperheating of discharge gas on compressors. In this case bulbs are mounted on the high pressure outlet of the compressor
 - Control of compressor oil temperatures
- Series 935 valves shall not be used to control superheat

Features

- Modular design for economical logistics and easy assembly and servicing
- Very good stability because of the large forces generated by the large diaphragm diameter
- High quality materials and processes for high reliability and long lifetime
- Combinations of different charges with various orifice springs cover a very large application range
- PS: 31 bar, TS: -45 ... +65°C
- No CE marking according art. 3.3 PED 97/23 EC
- Non-standard connection sizes see page 86



935

Type Code

935 - 7 - B WL 10x16

Valve Series
 Temperature Code
 Capacity Code
 Flange Style
 WL=Angle Style
 DL=Straight through
 Connection Size

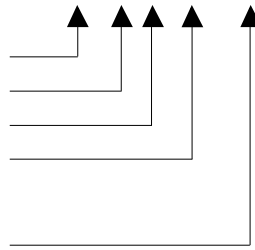

Type Code

XB1019 YL -2A

Power Assembly
 Charge Code
 Capillary Tube Length (3m)

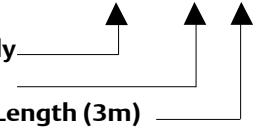

Series	Nominal Capacity Q _n kW					Orifice	Standard Flange, Angle Solder/ODF		Power Assembly
	R 134a	R 22	R 404A	R 407C	R 507		mm	Inch	
935-*	A	4,0	5,2	3,8	5,6	3,8	C 501 - 5 mm 10 x 16	C 501 - 5 3/8 x 5/8	XB1019 - * - 2A
	B	7,8	10,1	7,4	10,9	7,4			
	C	11,1	14,2	10,3	15,4	10,3			
	D	16,3	21,1	15,6	22,8	15,6	C 501 - 7 mm 12 x 16	C 501 - 7 1/2 x 5/8	
	E	22,5	28,9	21,0	31,2	21,0	A 576 mm 16 x 22 (22 x 28 ODM)	A 576 5/8 x 7/8 (7/8 x 1-1/8 ODM)	
	G	32,0	41,2	29,9	44,5	29,9			
	X	46,6	60,0	43,5	64,9	43,5			
* = Temperature Code		Temperature Range °C				* = Spring Code		* = Charge Code	
3		-1 / +17				B		UL	
6		+14 / +38				C		KL	
7		+36 / +50				A		YL	
105		+44 / +70				C		YL	
106		+66 / +94				C		JL	
100		+94 / +121				C		LL	

Nominal capacity (Q_n) is based on the following conditions:

Refrigerant	Evaporating temperature	Condensing temperature	Sub-cooling
R 407C	+4°C dew point	+38°C bubble p. +43°C dew point	1K
R 22, R 134a, R 404A, R 507	+4°C	+38°C	1K

Valve selection at other operating conditions see page 83.

Accessories

Description	Type	Part No.
Gasket Set for 935 Series Valves	X 13455 -1	027 579
Service Tool for 935 Series	X 99999	800 005
Steel screws for following flange types: C501 , 9761 , 6346 , A576	Screw ST 32	803 573

Correction Tables for Series 935

Valve selection for operating conditions other than nominal conditions:

$$Q_n = Q_o \times K_t \times K_{\Delta p}$$

- Q_n : Nominal valve capacity
- Q_o : Required cooling or desuperheating capacity
- K_t : Correction factor for evaporating and liquid temperature
- $K_{\Delta p}$: Correction factor for pressure drop at valve

Liquid Temperature entering Valve °C	R 134a															
	Correction Factor K_t Evaporating Temperature °C															
	+30	+25	+20	+15	+10	+5	0	-5	-10	-15	-20	-25	-30			
+60	1,22	1,25	1,27	1,30	1,33	1,36	1,40	1,44	1,48	1,51	1,56	1,61	1,67			
+55	1,14	1,16	1,18	1,21	1,23	1,26	1,29	1,33	1,36	1,39	1,43	1,47	1,52			
+50	1,07	1,08	1,10	1,13	1,15	1,17	1,20	1,23	1,26	1,28	1,32	1,36	1,39			
+45	1,00	1,02	1,04	1,06	1,08	1,10	1,12	1,15	1,17	1,19	1,22	1,26	1,29			
+40	0,93	0,96	0,98	0,99	1,01	1,03	1,05	1,08	1,10	1,12	1,14	1,17	1,20			
+35	0,90	0,91	0,92	0,94	0,96	0,97	0,99	1,01	1,03	1,05	1,07	1,10	1,12			
+30	0,85	0,86	0,88	0,89	0,91	0,92	0,94	0,96	0,98	0,99	1,01	1,03	1,06			
+25		0,82	0,83	0,85	0,86	0,87	0,89	0,91	0,92	0,94	0,95	0,97	1,00			
+20			0,80	0,81	0,82	0,83	0,85	0,89	0,88	0,89	0,91	0,92	0,94			
+15				0,77	0,78	0,79	0,81	0,82	0,84	0,84	0,86	0,88	0,89			
+10					0,75	0,76	0,77	0,78	0,80	0,81	0,82	0,84	0,85			
+5						0,73	0,74	0,75	0,76	0,77	0,78	0,80	0,81			
0							0,71	0,72	0,73	0,74	0,75	0,76	0,78			
-5								0,69	0,70	0,71	0,72	0,73	0,74			
-10									0,68	0,68	0,69	0,70	0,71			
Correction Factor $K_{\Delta p}$																
Δp (bar)	0,5	1,0	1,5	2,0	2,5	3,0	3,5	4,0	4,5	5,0	5,5	6,0	6,5	7,0	7,5	8,0
$K_{\Delta p}$	3,50	2,48	2,02	1,75	1,57	1,43	1,32	1,24	1,17	1,11	1,06	1,01	0,97	0,94	0,90	0,88
Δp (bar)	8,5	9,0	9,5	10,0	10,5	11,0	11,5	12,0	13,0	14,0	15,0	16,0	17,0	18,0	19,0	20,0
$K_{\Delta p}$	0,85	0,83	0,80	0,78	0,76	0,75	0,73	0,72	0,69	0,66	0,64	0,62	0,60	0,58	0,57	0,55

Liquid Temperature entering Valve °C	R 22															
	Correction Factor K_t Evaporating Temperature °C															
	+30	+25	+20	+15	+10	+5	0	-5	-10	-15	-20	-25	-30	-35	-40	-45
+60	1,22	1,23	1,24	1,25	1,27	1,28	1,30	1,32	1,34	1,36	1,38	1,41	1,44	1,47	1,50	1,53
+55	1,15	1,16	1,17	1,18	1,19	1,20	1,22	1,24	1,25	1,27	1,29	1,32	1,34	1,37	1,39	1,42
+50	1,08	1,09	1,10	1,11	1,12	1,14	1,15	1,16	1,18	1,20	1,22	1,24	1,26	1,28	1,30	1,33
+45	1,03	1,04	1,04	1,05	1,06	1,07	1,09	1,10	1,12	1,13	1,15	1,17	1,18	1,20	1,23	1,25
+40	0,98	0,99	0,99	1,00	1,01	1,02	1,03	1,04	1,06	1,07	1,09	1,10	1,12	1,14	1,16	1,18
+35	0,93	0,94	0,95	0,95	0,96	0,97	0,98	0,99	1,01	1,02	1,03	1,05	1,06	1,08	1,10	1,12
+30	0,89	0,90	0,90	0,91	0,92	0,93	0,94	0,95	0,96	0,97	0,98	1,00	1,01	1,03	1,04	1,06
+25		0,86	0,87	0,87	0,88	0,89	0,90	0,91	0,92	0,93	0,94	0,95	0,96	0,98	0,99	1,01
+20			0,83	0,84	0,84	0,85	0,86	0,87	0,88	0,89	0,90	0,91	0,92	0,93	0,95	0,96
+15				0,80	0,81	0,82	0,82	0,83	0,84	0,85	0,86	0,87	0,88	0,89	0,91	0,92
+10					0,78	0,79	0,79	0,80	0,81	0,82	0,83	0,84	0,85	0,86	0,87	0,88
+5						0,76	0,76	0,77	0,78	0,79	0,79	0,80	0,81	0,82	0,83	0,85
0							0,74	0,74	0,75	0,76	0,77	0,77	0,78	0,79	0,80	0,81
-5								0,72	0,72	0,73	0,74	0,75	0,75	0,76	0,77	0,78
-10									0,70	0,71	0,71	0,72	0,73	0,71	0,74	0,75
Correction Factor $K_{\Delta p}$																
Δp (bar)	0,5	1,0	1,5	2,0	2,5	3,0	3,5	4,0	4,5	5,0	5,5	6,0	6,5	7,0	8,0	9,0
$K_{\Delta p}$	4,25	3,00	2,46	2,13	1,90	1,74	1,61	1,50	1,42	1,35	1,28	1,23	1,18	1,14	1,06	1,00
Δp (bar)	10,0	11,0	12,0	13,0	14,0	15,0	16,0	17,0	18,0	19,0	20,0	21,0	22,0	23,0	24,0	25,0
$K_{\Delta p}$	0,95	0,91	0,87	0,83	0,80	0,78	0,75	0,73	0,71	0,69	0,67	0,66	0,64	0,63	0,61	0,60

Liquid Temperature entering Valve °C	R 404A															
	Correction Factor K_t Evaporating Temperature °C															
	+30	+25	+20	+15	+10	+5	0	-5	-10	-15	-20	-25	-30	-35	-40	-45
+60	1,56	1,59	1,64	1,69	1,74	1,81	1,88	1,96	2,06	2,16	2,28	2,42	2,57	2,75	2,95	3,19
+55	1,32	1,35	1,38	1,42	1,46	1,50	1,55	1,61	1,68	1,75	1,83	1,92	2,01	2,13	2,25	2,39
+50	1,16	1,18	1,20	1,23	1,26	1,30	1,34	1,38	1,43	1,48	1,54	1,61	1,68	1,75	1,84	1,94
+45	1,04	1,05	1,07	1,10	1,12	1,15	1,18	1,22	1,26	1,30	1,34	1,39	1,45	1,51	1,57	1,64
+40	0,94	0,96	0,97	0,99	1,02	1,04	1,07	1,09	1,13	1,16	1,20	1,24	1,28	1,33	1,38	1,43
+35	0,87	0,88	0,90	0,91	0,93	0,95	0,97	1,00	1,02	1,05	1,08	1,11	1,15	1,19	1,23	1,27
+30	0,81	0,82	0,83	0,84	0,86	0,88	0,90	0,92	0,94	0,96	0,99	1,02	1,05	1,08	1,11	1,15
+25		0,76	0,77	0,79	0,80	0,82	0,83	0,85	0,87	0,89	0,92	0,94	0,97	0,99	1,02	1,05
+20			0,73	0,74	0,75	0,77	0,78	0,80	0,81	0,83	0,85	0,87	0,90	0,92	0,95	0,97
+15				0,70	0,71	0,72	0,73	0,75	0,76	0,78	0,80	0,82	0,84	0,86	0,88	0,90
+10					0,67	0,68	0,69	0,71	0,72	0,74	0,75	0,77	0,79	0,81	0,83	0,85
+5						0,65	0,66	0,67	0,68	0,70	0,71	0,73	0,74	0,76	0,78	0,80
0							0,63	0,64	0,65	0,66	0,68	0,69	0,71	0,72	0,74	0,75
-5								0,61	0,62	0,63	0,65	0,66	0,67	0,69	0,70	0,72
-10									0,60	0,61	0,62	0,63	0,64	0,65	0,67	0,68
Correction Factor $K_{\Delta p}$																
Δp (bar)	0,5	1,0	1,5	2,0	2,5	3,0	3,5	4,0	4,5	5,0	5,5	6,0	6,5	7,0	8,0	9,0
$K_{\Delta p}$	4,55	3,21	2,62	2,27	2,03	1,86	1,72	1,61	1,52	1,44	1,37	1,31	1,26	1,21	1,14	1,07
Δp (bar)	10,0	11,0	12,0	13,0	14,0	15,0	16,0	17,0	18,0	19,0	20,0	21,0	22,0	23,0	24,0	25,0
$K_{\Delta p}$	1,02	0,97	0,93	0,89	0,86	0,83	0,80	0,78	0,76	0,74	0,72	0,70	0,69	0,67	0,66	0,64

Liquid Temperature entering Valve °C	R 407C											
	Correction Factor K_t Evaporating Temperature °C											
	+30	+25	+20	+15	+10	+5	0	-5	-10	-15	-20	-25
+55	1,20	1,21	1,23	1,26	1,28	1,31	1,34	1,37	1,40	1,44	1,48	1,52
+50	1,10	1,11	1,13	1,15	1,17	1,19	1,22	1,24	1,27	1,30	1,33	1,37
+45	1,02	1,03	1,05	1,06	1,08	1,10	1,12	1,14	1,17	1,19	1,22	1,25
+40	0,95	0,96	0,98	0,99	1,01	1,02	1,04	1,06	1,08	1,11	1,13	1,16
+35	0,89	0,90	0,92	0,93	0,94	0,96	0,98	0,99	1,01	1,03	1,05	1,07
+30	0,85	0,85	0,87	0,88	0,89	0,90	0,92	0,93	0,95	0,97	0,99	1,01
+25		0,81	0,82	0,83	0,84	0,85	0,87	0,88	0,90	0,91	0,93	0,95
+20			0,78	0,79	0,80	0,81	0,82	0,84	0,85	0,86	0,88	0,90
+15				0,75	0,76	0,77	0,78	0,80	0,81	0,82	0,84	0,85
+10					0,73	0,74	0,75	0,76	0,77	0,78	0,80	0,81
+5						0,71	0,72	0,73	0,74	0,75	0,76	0,77
0							0,69	0,70	0,71	0,72	0,73	0,74
-5								0,67	0,68	0,69	0,70	0,71
-10									0,65	0,66	0,67	0,68

Correction Factor $K_{\Delta p}$																
Δp (bar)	0,5	1,0	1,5	2,0	2,5	3,0	3,5	4,0	4,5	5,0	5,5	6,0	6,5	7,0	8,0	9,0
$K_{\Delta p}$	4,78	3,33	2,72	2,36	2,11	1,92	1,78	1,67	1,57	1,49	1,42	1,36	1,31	1,26	1,18	1,11
Δp (bar)	10,0	11,0	12,0	13,0	14,0	15,0	16,0	17,0	18,0	19,0	20,0	21,0	22,0	23,0	24,0	25,0
$K_{\Delta p}$	1,05	1,01	0,96	0,92	0,89	0,86	0,83	0,81	0,79	0,76	0,75	0,73	0,71	0,70	0,68	0,67

Note: See page 62 for determining of conditions for systems with R 407C.

Liquid Temperature entering Valve °C	R 507															
	Correction Factor K_t Evaporating Temperature °C															
	+30	+25	+20	+15	+10	+5	0	-5	-10	-15	-20	-25	-30	-35	-40	-45
+60	1,54	1,57	1,61	1,65	1,71	1,76	1,83	1,90	1,98	2,08	2,18	2,30	2,43	2,58	2,75	2,95
+55	1,30	1,33	1,36	1,39	1,43	1,47	1,52	1,57	1,62	1,69	1,76	1,83	1,92	2,02	2,12	2,25
+50	1,15	1,17	1,19	1,22	1,24	1,28	1,31	1,35	1,40	1,44	1,49	1,55	1,61	1,68	1,76	1,84
+45	1,03	1,05	1,07	1,09	1,11	1,14	1,17	1,20	1,23	1,27	1,31	1,36	1,40	1,46	1,52	1,58
+40	0,94	0,96	0,97	0,99	1,01	1,03	1,06	1,08	1,11	1,14	1,17	1,21	1,25	1,29	1,34	1,39
+35	0,87	0,88	0,90	0,91	0,93	0,95	0,97	0,99	1,01	1,04	1,07	1,10	1,13	1,16	1,20	1,24
+30	0,81	0,82	0,83	0,85	0,86	0,88	0,89	0,91	0,93	0,96	0,98	1,01	1,03	1,06	1,09	1,13
+25		0,77	0,78	0,79	0,80	0,82	0,83	0,85	0,87	0,89	0,91	0,93	0,95	0,98	1,01	1,03
+20			0,73	0,74	0,75	0,77	0,78	0,79	0,81	0,83	0,85	0,87	0,89	0,91	0,93	0,96
+15				0,70	0,71	0,72	0,73	0,75	0,76	0,78	0,79	0,81	0,83	0,85	0,87	0,89
+10					0,67	0,68	0,69	0,70	0,72	0,73	0,74	0,76	0,78	0,79	0,81	0,83
+5						0,64	0,65	0,67	0,68	0,69	0,70	0,72	0,73	0,75	0,76	0,78
0							0,62	0,63	0,64	0,65	0,66	0,68	0,69	0,70	0,72	0,73
-5								0,60	0,61	0,62	0,63	0,64	0,65	0,66	0,68	0,69
-10									0,58	0,59	0,60	0,61	0,62	0,63	0,64	0,65

Correction Factor $K_{\Delta p}$																
Δp (bar)	0,5	1,0	1,5	2,0	2,5	3,0	3,5	4,0	4,5	5,0	5,5	6,0	6,5	7,0	8,0	9,0
$K_{\Delta p}$	4,63	3,27	2,67	2,31	2,07	1,89	1,75	1,64	1,54	1,46	1,40	1,34	1,28	1,24	1,16	1,09
Δp (bar)	10,0	11,0	12,0	13,0	14,0	15,0	16,0	17,0	18,0	19,0	20,0	21,0	22,0	23,0	24,0	25,0
$K_{\Delta p}$	1,03	0,99	0,94	0,91	0,87	0,85	0,82	0,79	0,77	0,75	0,73	0,71	0,70	0,68	0,67	0,65

Flanges for Valves

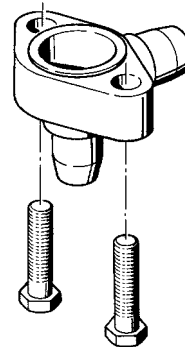

**Angle Style Flange
(WL)**

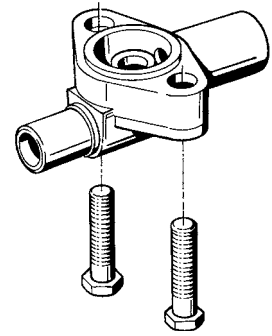

**Straight Through Flange
(DL)**

Angle Style		Straight Through		Connections				for Valve Series
Type	Part No.	Type	Part No.	mm		inch		
				Solder ODF	Solder ODM	Solder ODF	Solder ODM	
C 501 - 5	803 232	9761 - 3	803 240	—	—	3/8 x 5/8	—	TCLE
C 501 - 5 MM	803 233	9761 - 3 MM	803 241	10 x 16	—	—	—	ZZCE
C 501 - 7	803 234	9761 - 4	803 350	—	—	1/2 x 5/8	—	LCLE
C 501 - 7 MM	803 235	9761 - 4 MM	803 243	12 x 16	—	—	—	935 A-X
—	—	6346 - 17	803 330	16 x 22	—	5/8 x 7/8	—	CPHE 1
A 576	803 238	—	—	—	—	5/8 x 7/8	7/8 x 1-1/8	CPHE 2
A 576 - MM	803 239	—	—	16 x 22	22 x 28	—	—	
10331	803 338	10332	803 324	22 x 22	—	7/8 x 7/8	1-1/8 x 1-1/8	TJRE ZZJRE LJRE CPHE 3
9153 9153 MM	803 244 803 245	9152 9152 MM	803 286 803 287	— 22 x 22	— 28 x 28	7/8 x 7/8 —	1-1/8 x 1-1/8	TERE TIRE ZZERE ZZIRE LERE LIRE CPHE 3,5 CPHE 4 CPHE 5
9149	803 284	9148	803 283	22 x 22	—	7/8 x 7/8	1-1/8 x 1-1/8	THRE CPHE 6

Solenoid Valves

2-Way Solenoid Valves

Basic Terms and Technical Information

Operating principles

Directly actuated: The magnetic field of the solenoid coil forces a movement of the plunger and thus causes the opening of the valve seat.

Servo actuated: The magnetic field of the solenoid coil is only utilized for the opening of the pilot valve seat. The necessary energy to actuate the piston or diaphragm of the main valve seat is provided by the refrigerant flow and results in a certain pressure drop.

Minimum pressure drop

Directly actuated solenoid valves do not require a minimum pressure drop for proper operation. Servo operated solenoid valves require a minimum pressure drop of approximately 0.05 bar to remain fully open. In case of insufficient refrigerant flow this value will not be reached and the solenoid valve may close unintentionally. These closures may lead to malfunctions and oscillations in the refrigeration circuit. Improper sizing of solenoid valves (i.e. use of excessively large solenoid valves) is the main cause of this effect. This is particularly important in capacity controlled refrigeration circuits.

Therefore the decisive factor for proper solenoid valve sizing is the respective capacity of the valve and not its connection size.

Formula for calculating the actual pressure drop of a solenoid valve:

$$\Delta_{p1} = \Delta_{p2} \times (Q_{n1}/Q_{n2})^2$$

- Δ_{p1} : Actual pressure drop
- Δ_{p2} : Nominal pressure drop at Q_{n1}
- Q_{n1} : Calculated nominal capacity
- Q_{n2} : Nominal capacity of selected valve

Maximum Operating Pressure Differential (MOPD)

MOPD is the maximum pressure differential between inlet and outlet of the solenoid valve which permits proper opening of the valve. When used with ALCO AC solenoid coils all ALCO solenoid valves employ 25 bar MOPD.

Operation in conjunction with DC solenoid coils lead to reduced MOPD values depending on valve type and size.

The **DS2 Chopper Plugs** allow the use of 24VAC coils with 24VDC by converting the DC in an AC voltage. Please contact ALCO application engineering for additional details.

Selection Guide for Solenoid Valves

Selection Criteria	Series						
	110 RB	200 RB	240 RA		540 RA		M36
			8/9/12/16T9	16T11/20	8/9/12/16	20	
2-Way	+	+	+	+	+	+	
3-Way							+
Normally Closed (NC)	+	+	+	+			
Normally Open (NO)					+	+	
Min. Pressure Differential (bar)	0.00	0.05	0.05	0.05	0.05	0.05	
MWP (bar)	35	35	35	31	35	28	35
Media Temp. Range (°C)	-40 / +120	-40 / +120	-40 / +120	-40 / +120	-40 / +120	-40 / +120	-40 / +120
Coil Type	ASC	ASC	ASC	ASC	ASC	ASC	ASC
Catalogue Page	90	90	90	90	91	91	94

Type Code

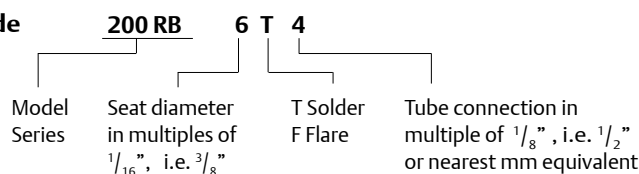

Coils ASC

Standards

- ALCO ASC Coils and cable assemblies conform to Low Voltage Directive



ASC

Type	Part No.	Voltage	Power Input	Electr. Connection	Protection
ASC 230V / 50Hz	801 064	AC	8 W	without plug, see cable assemblies	IP65 with plug / cable assembly
ASC 120V / 50Hz	801 063				
ASC 24V / 50Hz	801 062				
ASC 12V	801 054	DC	15 W		
ASC 120V	801 050				
ASC 230V	801 056				

Note: Coils are delivered with mounting clip.
Please order cable assemblies separately.



ASC-N15

Cable Assemblies for ASC Coils

Type	Part No.	Temperature Range	Cable length	Wire diameter	Connector Type
ASC-N15	804 570	-25 ..+80°C	1,5m	3 x 0,75 mm ²	loose wires
ASC-N30	804 571		3,0m		
ASC-N60	804 572		6,0m		
ASC-L15	804 573	-50..+80°C	1,5m		
ASC-L30	804 574		3,0m		
ASC-L60	804 575		6,0m		

Cable Assemblies with 24V DC Chopper Plug

- Enables standard 24V AC Coil to be used for DC applications
- Low power assumption (3W only)
- No MOPD degradation



DS2-N15

Type	Part No.	Temperature Range	Cable length	Wire diameter	Connector Type
DS2-N15	804 620	-25 .. +80°C	1,5m	2 x 0,75 mm ²	loose wires
DS2-N30	804 621		3,0m		
DS2-N60	804 622		6,0m		

Other Accessories for Solenoid Valves

Type	Part No.	Description
X 11981 - 1	027 451	Service tool for 110RB, 240RA, 540RA, 3031
X 13983 -1	027 622	Mounting bracket for 240RA
X 13740 -1	027 600	Clip for coil
PG9 Plug	801 012	Plug according to DIN 43650 with cable gland PG 9
PG11 Plug	801 013	Plug according to DIN 43650 with cable gland PG 11

2-Way Solenoid Valves Series 110, 200, 240

Normally Closed

Features

- Compact size
- Snap-on clip for attaching solenoid coils
- No disassembly necessary for soldering

Standards

- 240 RA 16T11 and 20 are CE marked per PED

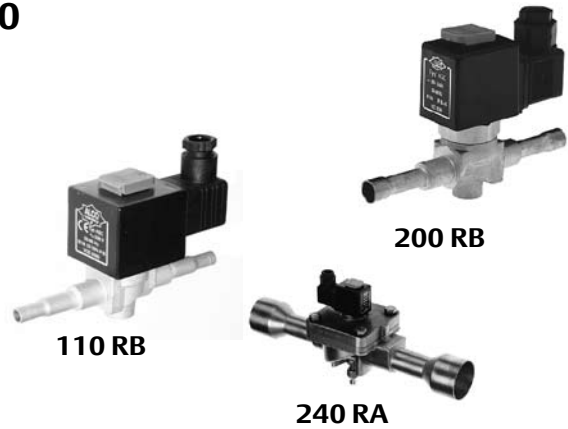

Capacity Data

Type	Nominal Capacity Q_n (kW)												kv-value m ³ /h	Δp min bar
	Liquid				Hot Gas				Suction Gas					
	R 134a	R 22	R 404A		R 134a	R 22	R 404A		R 134a	R 22	R 507	R 407C		
110 RB 2	3,5	3,8	2,5	3,6	1,6	2,0	1,7	2,1					0,2	0
200 RB 3	6,6	7,1	4,6	6,8	3,0	3,7	3,2	3,9					0,4	0,05
200 RB 4	15,5	16,8	10,9	16,1	7,1	8,8	7,5	9,2					0,9	0,05
200 RB 6	27,3	29,5	18,9	28,0	12,5	15,4	13,1	16,1					1,6	0,05
240 RA 8	36,3	39,3	25,2	37,3	16,7	20,5	17,4	21,4	4,2	5,6	4,6	5,2	2,3	0,05
240 RA 9	76,2	82,5	52,9	78,4	35,1	43,1	36,5	44,9	8,8	11,7	9,7	10,9	4,8	0,05
240 RA 12	85,7	92,8	59,5	88,1	39,4	48,4	41,1	50,5	9,9	13,1	10,9	12,3	5,4	0,05
240 RA 16	139,1	150,5	96,5	142,9	64,0	78,5	66,6	81,9	16,0	21,3	17,7	19,9	8,8	0,05
240 RA 20	202,6	219,3	140,7	208,3	93,2	114,4	97,1	119,3	33,0	31,0	25,7	29,0	12,8	0,05

Selection Guide

Type	Part No.	Connection Solder / ODF	
		mm	Inch
110 RB 2	T2	801 217	6
	T2	801 210	1/4
	T3	801 209	10
200 RB 3	T3	801 239	10
200 RB 4	T3	801 176	10
	T3	801 190	3/8
	T4	801 178	12
	T4	801 179	1/2
200 RB 6	T4	801 182	12
	T4	801 183	1/2
	T5	801 186	16
240 RA 8	T5	801 160	5/8
	T7	801 143	7/8
240 RA 9	T5	801 161	16
	T7	801 162	22
	T9	801 142	1-1/8
240 RA 12	T7	801 163	22
	T9	801 144	1-1/8
240 RA 16	T9	801 164	1-1/8
	T11	801 166	35
240 RA 20	T11-M	801 172	35
	T13-M	801 224	42
	T13-M	801 173	1-5/8
	T17-M	801 174	54

Nominal capacities at +38°C condensing temperature, +4°C evaporating temperature, 0.15 bar pressure drop between valve inlet and outlet in liquid applications (for hot gas applications 1 bar pressure drop and +18°C suction gas temperature); subcooling 1 K.

Correction tables for other operating conditions see page 92.

Special Versions:

- Manual stems available upon request for Series 240 RA 8 to 240 RA 16 (Type M).

Manual stems standard on Series 240 RA 20.

Options:

- Actuation coils available for various voltages, see page 89.

2-Way Solenoid Valves Series 540

Normally Open

Features

- Compact size
- Snap-on clip for attaching solenoid coils
- No disassembly necessary for soldering



540 RA

Capacity Data

Type	Nominal Capacity Q_n (kW)												kv-value m ³ /h	Δp min bar
	Liquid				Hot Gas				Suction Gas					
	R 134a	R 22	R 404A R 507	R 407C	R 134a	R 22	R 404A R 507	R 407C	R 134a	R 22	R 507	R 407C		
540 RA 8	36,3	39,3	25,2	37,3	16,7	20,5	17,4	21,4	4,2	5,6	4,6	5,2	2,3	0,05
540 RA 9	76,2	82,5	52,9	78,4	35,1	43,1	36,5	44,9	8,8	11,7	9,7	10,9	4,8	0,05
540 RA 12	85,7	92,8	59,5	88,1	39,4	48,4	41,1	50,5	9,9	13,1	10,9	12,3	5,4	0,05
540 RA 16	139,1	150,5	96,5	142,9	64,0	78,5	66,6	81,9	16,0	21,3	17,7	19,9	8,8	0,05
540 RA 20	202,6	219,3	140,7	208,3	93,2	114,4	97,1	119,3	23,3	31,0	25,7	29,0	12,8	0,05

Nominal capacities at +38°C condensing temperature, +4°C evaporating temperature, 0.15 bar pressure drop between valve inlet and outlet in liquid applications (for hot gas applications 1 bar pressure drop and +18 °C suction gas temperature); subcooling 1 K.

Correction tables for other operating conditions see page 92.

Selection Guide

Type	Part No.	Connection Solder /ODF	
		mm	Inch
540 RA 8	T5	046 265	5/8
540 RA 9	T5	046 266	5/8
	T7	046 268	22
540 RA 12	T7	046 269	22
540 RA 16	T9	046 270	1-1/8
540 RA 20	T11	047 953	35

Options:

- Actuation coils and cable assemblies available for various voltages, see page 89.

Accessories and spare parts for solenoid valves

Description	Type	Part No.
Service tool for 110 RB, 240 RA, 540 RA	X 11981 - 1	027 451
Mounting bracket for 240 RA / 540 RA	X 13983 - 1	027 622
Changeover kit T to M		
240RA8	KS 30066	801 265
240RA9/12	KS 30067	801 261
240RA16	KS 30068	801 266
240RA20	KS 30098	801 267
Gasket kits		
110RB	KS 30040-2	801 232
200RB	KS 30039-1	801 233
240RA8	KS 30061-1	801 234
240RA9/12	KS 30062-1	801 235
240RA16	KS 30065-1	801 236
240RA20	KS 30097-1	801 237

Repair Kits	Type	Part No.
110RB	KS 30040-1	801 206
200RB	KS 30039 / KS 30109	801 205
240RA8	KS 30061	801 262
240RA9	KS 30062	801 263
240RA12	KS 30063	801 264
240RA16	KS 30065	801 200
240RA20	KS 30097	801 216

Correction Tables for the Selection of Solenoid Valves

For use with 110 RB, 200 RB, 240 RA and 540 RA Series

Valve selection for operating conditions other than nominal:

The pressure drop can be calculated with the following formula:

$$Q_n = Q_o \times K_t \times K_{\Delta p}$$

$$\Delta P_o = \Delta P_n \times \frac{Q_o^2}{Q_n^2}$$

- Q_n : Nominal valve capacity
- K_t : Correction factor for evaporating and liquid temperature
- $K_{\Delta p}$: Correction factor for pressure drop at valve
- Q_o : Required cooling capacity

- $\Delta P_n = 0,15 \text{ bar}$
- ΔP_n : Pressure drop under nominal conditions

1. Suction Gas Application

Evaporating Temperature °C	Correction Factor K_t										
	Condensing Temperature °C										
	+60	+55	+50	+45	+40	+35	+30	+25	+20		
+10	1,03	0,97	0,92	0,88	0,84	0,80	0,76	0,74	0,71		
0	1,40	1,32	1,25	1,20	1,14	1,10	1,04	1,01	0,96		
-10	1,71	1,62	1,53	1,47	1,40	1,34	1,27	1,23	1,18		
-20	2,20	2,08	1,97	1,88	1,80	1,72	1,64	1,58	1,51		
-30	2,79	2,63	2,50	2,39	2,27	2,19	2,07	2,01	1,92		
-40	3,68	3,47	3,29	3,15	3,00	2,89	2,73	2,65	2,53		
Correction Factor $K_{\Delta p}$											
Δp (bar)	0,05	0,10	0,15	0,20	0,25	0,30	0,35	0,40	0,45	0,50	0,55
$K_{\Delta p}$	1,73	1,22	1,00	0,87	0,77	0,71	0,65	0,61	0,48	0,55	0,52

2. Liquid Application

Liquid Temperature entering Valve °C	Correction Factor K_t														
	R 134a					R 22									
	Evaporating Temperature °C														
	+10	0	-10	-20	-30	+10	0	-10	-20	-30	-40				
+60	1,33	1,40	1,48	1,56	1,67	1,26	1,30	1,38	1,38	1,44	1,50				
+55	1,23	1,29	1,36	1,43	1,52	1,19	1,22	1,29	1,29	1,34	1,39				
+50	1,15	1,20	1,26	1,32	1,39	1,12	1,15	1,21	1,22	1,26	1,30				
+45	1,08	1,12	1,17	1,22	1,29	1,06	1,08	1,15	1,15	1,18	1,23				
+40	1,01	1,05	1,10	1,14	1,20	1,01	1,03	1,09	1,09	1,12	1,16				
+35	0,96	0,99	1,03	1,07	1,12	0,96	0,98	1,03	1,03	1,06	1,10				
+30	0,91	0,94	0,98	1,01	1,06	0,92	0,94	0,99	0,98	1,01	1,04				
+25	0,86	0,89	0,92	0,95	1,00	0,88	0,89	0,94	0,94	0,96	0,99				
+20	0,82	0,85	0,88	0,91	0,94	0,84	0,86	0,90	0,90	0,92	0,95				
+15	0,78	0,81	0,84	0,86	0,89	0,81	0,82	0,87	0,86	0,88	0,91				
+10	0,75	0,77	0,80	0,82	0,85	0,78	0,79	0,83	0,83	0,85	0,87				
+5		0,74	0,76	0,78	0,81		0,76	0,80	0,79	0,81	0,83				
0		0,71	0,73	0,75	0,78		0,73	0,77	0,77	0,78	0,80				
-5			0,70	0,72	0,74			0,74	0,74	0,75	0,77				
-10			0,68	0,69	0,71			0,72	0,71	0,73	0,74				
Correction Factor $K_{\Delta p}$															
Δp (bar)	0,05	0,10	0,15	0,20	0,25	0,30	0,35	0,40	0,45	0,50	0,55	0,60	0,65	0,70	0,75
$K_{\Delta p}$	1,73	1,22	1,00	0,87	0,77	0,71	0,65	0,61	0,58	0,55	0,52	0,50	0,48	0,46	0,45

2. Liquid Application

Liquid Temperature entering Valve °C	R 404A						Correction Factor K_t Evaporating Temperature °C						R 507					
	+10	0	-10	-20	-30	-40	+10	0	-10	-20	-30	-40	+10	0	-10	-20	-30	-40
+60	1,74	1,88	2,06	2,28	2,57	2,95	1,71	1,83	1,98	2,18	2,43	2,75						
+55	1,46	1,55	1,68	1,83	2,01	2,25	1,43	1,52	1,62	1,76	1,92	2,12						
+50	1,26	1,34	1,43	1,54	1,68	1,84	1,24	1,31	1,40	1,49	1,61	1,76						
+45	1,12	1,18	1,26	1,34	1,45	1,57	1,11	1,17	1,23	1,31	1,40	1,52						
+40	1,02	1,07	1,13	1,20	1,28	1,38	1,01	1,06	1,11	1,17	1,25	1,34						
+35	0,93	0,97	1,02	1,08	1,15	1,23	0,93	0,97	1,01	1,07	1,13	1,20						
+30	0,86	0,90	0,94	0,99	1,05	1,11	0,86	0,89	0,93	0,98	1,03	1,09						
+25	0,80	0,83	0,87	0,92	0,97	1,02	0,80	0,83	0,87	0,91	0,95	1,01						
+20	0,75	0,78	0,81	0,85	0,90	0,95	0,75	0,78	0,81	0,85	0,89	0,93						
+15	0,71	0,73	0,76	0,80	0,84	0,88	0,71	0,73	0,76	0,79	0,83	0,87						
+10	0,67	0,69	0,72	0,75	0,79	0,83	0,67	0,69	0,72	0,74	0,78	0,81						
+5		0,66	0,68	0,71	0,74	0,78		0,65	0,68	0,70	0,73	0,76						
0		0,63	0,65	0,68	0,71	0,74		0,62	0,64	0,66	0,69	0,72						
-5			0,62	0,65	0,67	0,70			0,61	0,63	0,65	0,68						
-10			0,60	0,62	0,64	0,67			0,58	0,60	0,62	0,64						

Liquid Temperature entering Valve °C	R 407C				Correction Factor K_t Evaporating Temperature °C													
	+10	0	-10	-20														
+60																		
+55	1,28	1,34	1,40	1,48														
+50	1,17	1,22	1,27	1,33														
+45	1,08	1,12	1,17	1,22														
+40	1,01	1,04	1,08	1,13														
+35	0,94	0,98	1,01	1,05														
+30	0,89	0,92	0,95	0,99														
+25	0,84	0,87	0,90	0,93														
+20	0,80	0,82	0,85	0,88														
+15	0,76	0,78	0,81	0,84														
+10	0,73	0,75	0,77	0,80														
+5		0,72	0,74	0,76														
0		0,69	0,71	0,73														
-5			0,68	0,70														
-10			0,65	0,67														

Correction Factor $K_{\Delta p}$															
Δp (bar)	0,05	0,10	0,15	0,20	0,25	0,30	0,35	0,40	0,45	0,50	0,55	0,60	0,65	0,70	0,75
$K_{\Delta p}$	1,73	1,22	1,00	0,87	0,77	0,71	0,65	0,61	0,58	0,55	0,52	0,50	0,48	0,46	0,45

3. Hot Gas Application

K_t	Correction Factor K_t Evaporating Temperature °C											
	+10	+5	0	-5	-10	-15	-20	-25	-30	-35	-40	
K_t	0,96	1,00	1,03	1,06	1,10	1,13	1,17	1,20	1,24	1,29	1,33	

Correction Factor $K_{\Delta p}$										
Δp (bar)	0,35	0,50	0,70	1,00	1,50	2,00	2,50	3,00	4,00	
$K_{\Delta p}$	1,72	1,49	1,22	1,00	0,86	0,78	0,73	0,70	0,65	

3-Way Solenoid Valves Series M36

Features

- For heat reclaim application
- Pilot connection to suction line required, no minimum pressure drop
- Compact size
- Snap-on clip for attaching solenoid coils
- No disassembly necessary for brazing
- Max. working pressure PS: 35 bar

Options:

- Actuation coil and cable assemblies available for various voltages, see page 89



M36-118 M36-078 with ASC Coil and DS2 Chopper Plug

Capacity Data

Type	Part No.	Connection Solder/ODF		Nominal Capacity Q_n (kW)			kv-Value m^3/h	Coil Type
		mm	inch	R 134a	R 22	R 404A / R 507		
M36-078	801 420	22	7/8	28,9	35,1	31,3	6,7	ASC (Page 89)
M36-118	801 421		1-1/8					

Nominal capacities at +38°C condensing temperature, +4°C evaporating temperature (saturated pressures / dew point), 0.15 bar pressure drop between valve inlet and outlet.

For other operating conditions multiply required capacity Q_o with correction factors K_t and $K_{\Delta p}$.

$$Q_o \times K_t \times K_{\Delta p} = Q_n$$

- Q_o : Required cooling capacity
- K_t : Correction factor for evaporating and liquid temperature
- $K_{\Delta p}$: Correction factor for pressure drop at valve
- Q_n : Nominal valve capacity

Correction Tables

Correction Factor K_t											
Evaporating Temperature (°C)											
	10	5	0	-5	-10	-15	-20	-25	-30	-35	-40
K_t	0,96	1,00	1,03	1,06	1,10	1,13	1,17	1,20	1,24	1,29	1,33

Correction Factor $K_{\Delta p}$											
Pressure drop across Valve (bar)											
	0,10	0,14	0,20	0,30	0,40	0,50	0,60	0,70	0,80	0,90	1,00
$K_{\Delta p}$	1,22	1,00	0,87	0,71	0,61	0,55	0,50	0,46	0,43	0,41	0,39

Accessories and spare parts for series M36

Description	Part No.
Repair Kit for M36-UNF (O-Ring Gasket & pilot assembly)	801 440

Conversion Table 3031 Series to M36

3031 Series has been replaced by M36 Series

former type	Part No.	replacement	Part No.
3031 RC 12S7	055 939	M36-078	801 420
3031 RC 12S9	055 940	M36-118	801 421

Mechanical Pressure Regulators



Pressure Regulators

Basic Terms and Technical Information

Capacity regulators

Regulator series ACP and CPHE are hot gas bypass regulators and serve the purpose of compensating excess compressor capacity.

Thus they prevent the generation of evaporator pressures below predetermined levels.

In case of hot gas injection into the suction line, a liquid injection valve in conjunction with a solenoid valve is required to desuperheat the excessively hot suction gas. The capacity should not be reduced below 60 % of maximum in this application to avoid oil return problems.

With hot gas injection at the evaporator inlet, no liquid injection valve is necessary. The injection must be such that the incremental gas volume is taken into account. No problems with oil return should be expected even when regulating 100% of capacity.

Condensing pressure regulators

The HP series regulator are designed to keep condensing pressures above certain levels in case of low ambient temperatures.

Thus they ensure sufficient pressure at the inlet port of the expansion valve and permit trouble free start-up of the refrigerant circuit independent of ambient temperatures.

This kind of refrigeration circuit design is “flooding the condenser” at low ambient conditions and therefore requires increased receiver capacity.

Evaporator pressure regulators

Series PRE regulators serve the purpose of maintaining evaporator pressure above certain predetermined levels.

The most important application is the use of several evaporators with different evaporating temperatures in conjunction with a common suction line.

The freezing of water in water chillers and air-conditioning systems can be safely prevented if evaporating temperatures are kept above 0°C, even when loads are greatly reduced.

Crankcase pressure regulators

Series PRC regulators serve the purpose of preventing excessively high suction pressures to protect compressor motors from overloading.

Excessively high suction pressures can occur at start-up of a refrigeration circuit in case of high loads and after defrost. Crankcase regulators are adjusted to the maximum allowed suction pressure rating of the compressors as given by the compressor manufacturers.

Selection Guide for Pressure Regulators

Selection Criteria	Series				
	ACP	CPHE	HP	PRE	PRC
Head Pressure Control			+		
Capacity Control	+	+			
Evaporator Pressure Regulator				+	
Crankcase Pressure Regulator					+
Receiver Pressure Regulator			+		
Catalogue Page	97	97	99	101	102

Hot Gas Bypass Regulators Series ACP

Features

- High quality materials and processes for high reliability and long lifetime
- Internal equalization
- Compact size



ACP

Technical Data

Adjustment Range:	0 ... 5 bar
Factory Setting:	2,7 bar
Max. operating Pressure PS:	31 bar
Operating Temperature Range TS:	-40°C ... 120°C
Ambient Temperature Range:	-40 ... 50°C
Transport Temperature Range:	-40 ... 70°C

Capacity Data

Type	Part No.	Connection, Angle Solder/ODF inch	Nominal Bypass Capacity* Q _n kW			
			R 134a	R 22	R 407C	R 404A / R 507
ACP 1	047 680	1/4 x 3/8"	0.21	0.35	0.41	0.30
ACP 3	047 283	1/4 x 3/8"	0.50	0.77	0.89	0.68
ACP 5	053 374	3/8 x 3/8"	1.18	1.83	2.12	1.59

*) Nominal capacities at +38°C condensing temperature, +4°C evaporating temperature (saturated temperatures / dew point) and 1 K liquid subcooling at the inlet of the expansion valve.

Hot Gas Bypass Regulators Series CPHE

Features

- High quality materials and processes for high reliability and long lifetime
- Superior partial load performance due to double seat orifice design (CPHE-3 to CPHE-6)
- Modular design for economical logistics and easy assembly and servicing
- External equalization

Specific connection sizes and flanges available on request. Selection see page 86.



CPHE

Technical Data

Adjustment Range:	-0,4 ... 5 bar
Factory Setting:	1,4 bar
Max. operating Pressure PS:	28 bar
Operating Temperature Range TS:	-40°C ... 120°C
Ambient Temperature Range:	-40 ... 50°C
Transport Temperature Range:	-40 ... 70°C

Capacity Data CPHE

Type	Nominal Bypass Capacity Q_n kW				Orifice	Standard Flange Solder/ODF		Power Assembly
	R 134a	R 22	R 407C	R 404A/507		mm	inch	
CPHE - 1	3.3	4.6	5.4	4.3	X 22440-B5B	C 501 - 7 mm 12 x 16	C 501 - 7 $\frac{1}{2} \times \frac{5}{8}$	X7118 - 4
CPHE - 2	7.1	10.0	11.6	9.2	X 22440-B8B	A 576 mm 16 x 22 (22 x 28 ODM)	A 576 $\frac{5}{8} \times \frac{7}{8}$ ($\frac{7}{8} \times 1\text{-}\frac{1}{8}$ ODM)	
CPHE - 3	10.8	15.5	17.9	13.8	X 11873-B5B	10331 22 x 22	10331 $\frac{7}{8} \times \frac{7}{8}$ ($1\text{-}\frac{1}{8} \times 1\text{-}\frac{1}{8}$ ODM)	
CPHE - 3,5	15.4	21.7	25.1	19.5	X 9117-B7B	9153 mm 22 x 22	9153 $\frac{7}{8} \times \frac{7}{8}$ ($1\text{-}\frac{1}{8} \times 1\text{-}\frac{1}{8}$ ODM)	X7428 - 2
CPHE - 4	25.6	36.3	42.1	32.5	X 9117-B9B			
CPHE - 5	33.0	46.6	54.0	41.7	X 9166-B10B			
CPHE - 6	44.7	63.1	73.2	56.6	X 9144-B13B	9149 mm 22 x 22	9149 $\frac{7}{8} \times \frac{7}{8}$ ($1\text{-}\frac{1}{8} \times 1\text{-}\frac{1}{8}$ ODM)	

Nominal capacities at +38°C condensing temperature, +4°C evaporating temperature (saturated temperatures / dew point) and 1 K liquid subcooling at the inlet of the expansion valve.

Correction Tables for Series ACP and CPHE

For other evaporating temperatures the bypass capacity Q_{Byp} shall be multiplied with the correction factor K_{Byp} .

$$Q_{Byp} \times K_{Byp} = Q_n$$

- Q_{Byp} : Required bypass capacity
 K_{Byp} : Correction factor for evaporating temperature
 Q_n : Nominal valve capacity

Refrigerant	Condensing Temperature °C	Correction Factor K_{Byp} Evaporating Temperature °C					
		+10	0	-10	-20	-30	-40
R 134a	50	0.78	0.77	0.78	0.80		
	40	0.99	0.94	0.93	0.94		
	30	1.35	1.21	1.15	1.14		
R 22	50	0.80	0.77	0.77	0.77	0.79	0.82
	40	1.00	0.93	0.91	0.91	0.92	0.95
	30	1.34	1.19	1.12	1.10	1.09	1.12
R 407C	50	0.83	0.82	0.83	0.86		
	40	0.99	0.95	0.95	0.97		
	30	1.26	1.17	1.13	1.13		
R 404A / R 507	50	0.86	0.85	0.87	0.91	0.97	1.06
	40	0.99	0.95	0.94	0.96	1.00	1.05
	30	1.26	1.13	1.09	1.08	1.10	1.14

Head Pressure Control Valves Series HP

Features

- Fast attainment of required minimal condensing pressure
- For larger capacities the HP can be applied in parallel
- Compact size; replacing a receiver pressure regulator (or a check valve) and a condensing pressure regulator respectively



HP

Technical Data

Max. Operating Pressure PS:	HP5/HP8	31bar
	HP14	28bar
Max. Test Pressure PT:	HP5/HP8	34,5bar
	HP14	31bar
Operating Temperature Range TS:	-40°C .. 150°C	
Ambient Temperature:	-40 ... 50°C	
Transport Temperature:	-40 ... 70°C	
Max. Body Temperature:	150°C	

Capacity Data

Type	Part No.	Connection Solder/ODF	Nominal Capacity Q _n kW (Minimum Capacity Q _n kW)							
			R134a	R22	R404A / R 507	R 407C				
HP5 T4	-165 803 531	1/2"	16.3	17.6	11.6	16.9				
	-225 803 545		(2.4)	(2.6)	(1.7)	(2.5)				
HP8 T5	-165 803 512	5/8"	43.9	47.5	30.6	45.6				
	-225 803 504						(8.8)	(9.5)	(6.1)	(9.1)
HP8 T7	- 95 803 518	22 mm / 7/8"	109.9	118.9	76.7	114.0				
	-165 803 519						(22.0)	(23.8)	(15.4)	(22.8)
	-225 803 521									
HP14 T11	-165 803 515	35 mm / 1-3/8"								
	-225 803 526									

Nominal capacities at +38°C condensing temperature, +4°C evaporating temperature (saturated temperatures / dew point) and 1 K liquid subcooling at the inlet of the expansion valve. Valve selection for other operating conditions see following page.

Temperature Codes for Minimum Condensing Temperatures

Temperature Code	R 134a	R 22	R 404A / R 507	R 407C
- 95	30°C			
-165	47°C	30°C	25°C	26°C
-225		43°C	35°C	37°C



Correction Tables for Series HP

Valve selection for operating conditions other than +4°C/+38°C and 1 K liquid subcooling:

$$Q_n = Q_o \times K_t \times K_{\Delta p}$$

- Q_n : Nominal valve capacity
- K_t : Correction factor for evaporating and liquid temperature
- $K_{\Delta p}$: Correction factor for pressure drop at valve
- Q_o : Required cooling capacity

Liquid Temperature entering Valve °C	Correction Factor K_t															
	Evaporating Temperature															
	R 134a				R 22						R 404A					
	+10	0	-10	-20	+10	0	-10	-20	-30	-40	+10	0	-10	-20	-30	-40
+60	1,33	1,40	1,48	1,56	1,26	1,30	1,33	1,38	1,44	1,50	1,74	1,88	2,06	2,28	2,57	2,95
+55	1,23	1,29	1,36	1,43	1,19	1,22	1,25	1,29	1,34	1,39	1,46	1,55	1,68	1,83	2,01	2,25
+50	1,15	1,20	1,26	1,32	1,12	1,15	1,18	1,21	1,26	1,30	1,26	1,34	1,43	1,54	1,68	1,84
+45	1,08	1,12	1,17	1,22	1,06	1,08	1,11	1,14	1,18	1,23	1,12	1,18	1,26	1,34	1,45	1,57
+40	1,01	1,05	1,10	1,14	1,01	1,03	1,05	1,08	1,12	1,16	1,02	1,07	1,13	1,20	1,28	1,38
+35	0,96	0,99	1,03	1,07	0,96	0,98	1,00	1,03	1,06	1,10	0,93	0,97	1,02	1,08	1,15	1,23
+30	0,91	0,94	0,98	1,01	0,92	0,94	0,96	0,98	1,01	1,04	0,86	0,90	0,94	0,99	1,05	1,11
+25	0,86	0,89	0,92	0,95	0,88	0,89	0,91	0,94	0,96	0,99	0,80	0,83	0,87	0,92	0,97	1,02
+20	0,82	0,85	0,88	0,91	0,84	0,86	0,87	0,90	0,92	0,95	0,75	0,78	0,81	0,85	0,90	0,95
+15	0,78	0,81	0,84	0,86	0,81	0,82	0,84	0,86	0,88	0,91	0,71	0,73	0,76	0,80	0,84	0,88
+10		0,77	0,80	0,82		0,79	0,81	0,82	0,85	0,87		0,69	0,72	0,75	0,79	0,83
+5		0,74	0,76	0,78		0,76	0,78	0,79	0,81	0,83		0,66	0,68	0,71	0,74	0,78
0			0,73	0,75			0,75	0,76	0,78	0,80			0,65	0,68	0,71	0,74
-5			0,70	0,72			0,74	0,74	0,75	0,77			0,62	0,65	0,67	0,70
-10				0,69				0,71	0,73	0,74				0,62	0,64	0,67

Correction Factor $K_{\Delta p}$														
Δp (bar)	0,10	0,15	0,20	0,25	0,30	0,35	0,40	0,45	0,50	0,55	0,60	0,65	0,70	
$K_{\Delta p}$	1,87	1,53	1,32	1,18	1,08	1,00	0,94	0,88	0,84	0,80	0,76	0,73	0,71	

Liquid Temperature entering Valve °C	Correction Factor K_t															
	Evaporating Temperature															
	R 407C				R 507											
	+10	0	-10	-20	+10	0	-10	-20	-30	-40						
+55	1,28	1,34	1,40	1,48	1,45	1,54	1,65	1,79	1,95	2,16						
+50	1,17	1,22	1,27	1,33	1,27	1,34	1,42	1,52	1,64	1,79						
+45	1,08	1,12	1,17	1,22	1,13	1,19	1,25	1,33	1,43	1,54						
+40	1,01	1,04	1,08	1,13	1,03	1,07	1,13	1,20	1,27	1,36						
+35	0,94	0,98	1,01	1,05	0,94	0,98	1,03	1,09	1,15	1,22						
+30	0,89	0,92	0,95	0,99	0,88	0,91	0,95	1,00	1,05	1,11						
+25	0,84	0,87	0,90	0,93	0,82	0,85	0,88	0,92	0,97	1,02						
+20	0,80	0,82	0,85	0,88	0,77	0,79	0,82	0,86	0,90	0,95						
+15	0,76	0,78	0,81	0,84	0,72	0,75	0,77	0,81	0,84	0,88						
+10		0,75	0,77	0,80		0,70	0,73	0,76	0,79	0,83						
+5		0,72	0,74	0,76		0,67	0,69	0,71	0,74	0,78						
0			0,71	0,73			0,65	0,68	0,70	0,73						
-5			0,68	0,70			0,62	0,64	0,66	0,69						
-10				0,67				0,61	0,63	0,65						

Correction Factor $K_{\Delta p}$														
Δp (bar)	0,10	0,15	0,20	0,25	0,30	0,35	0,40	0,45	0,50	0,55	0,60	0,65	0,70	
$K_{\Delta p}$	1,87	1,53	1,32	1,18	1,08	1,00	0,94	0,88	0,84	0,80	0,76	0,73	0,71	

Evaporator and Crankcase Pressure Regulator Series PRE and PRC

Features

- Compact design permits minimal space requirements
- Schrader valve on Inlet for ease of setting
- Direct operated regulator
- Balanced Port design provides accurate pressure control
- Copper tubes for easy soldering



Technical Data

Refrigerants	HFC, HCFC		Pressure change per turn:	
Oil compatibility	Mineral, Alkyl Benzene and Polyol-Ester (POE) lubricants		Valve size 1	0,6 bar
Max. operating pressure PS:	25 bar		Valve size 2	0,4 bar
Max. test pressure PT:	30 bar		Pressure range:	0,5 to 6,9 bar
Material, housing	CW509L (EN12420)		Factory setting:	2 bar
Temperature range	Storage	-30°C to 80°C	Weight:	
	Medium	TS: -30°C to 80°C	PRC/PRE-1..	0,6 kg
	Ambient	-30°C to 80°C	PRC/PRE-2..	1,3 kg

Evaporator Pressure Regulator Series PRE

Selection

Type	Part No.	Tube Connection ODF	Nominal Capacity* Q _n (kW)			
			R 134a	R 404A / R 507	R 407C	R 22
PRE - 11A	800 380	16 mm - 5/8"	3,0	4,5	4,5	4,8
PRE - 11B	800 381	22 mm - 7/8"				
PRE - 21C	800 382	28 mm	7,4	11,1	11,1	11,9
PRE - 21D	800 383	1 - 1/8"				

*Nominal capacities are based on evaporating Temperature +4°C, condensing temperature +38°C and a pressure drop of 1K.

Correction Table

Selection for operating conditions other than +38°C/+4°C and 1 K liquid subcooling at the inlet of the valve: $Q_n = Q_o \times K_t$

Q_n: Nominal valve capacity
Q_o: Required cooling capacity

Refrigerant	Condensing Temperature °C	Correction Factor K _t				
		Evaporating Temperature °C				
		10	0	-10	-20	-30
R 404A / R 507	60	1,35	1,91	2,77	4,18	6,53
	50	1,05	1,46	2,07	3,05	4,62
	40	0,88	1,22	1,71	2,48	3,69
	30	0,77	1,06	1,48	2,12	3,13
R 407C	55	1,02	1,42	2,04		
	50	0,94	1,31	1,87		
	40	0,84	1,17	1,66		
R 134a	30	0,77	1,06	1,50		
	60	1,04	1,51	2,17		
	50	0,92	1,34	1,91		
R 22	40	0,83	1,20	1,71		
	30	0,76	1,1	1,55		
	60	1,02	1,37	1,87	2,67	3,91
	50	0,93	1,25	1,70	2,42	3,53
R 22	40	0,86	1,15	1,57	2,22	3,23
	30	0,80	1,07	1,45	2,05	2,98

Crankcase Pressure Regulator Series PRC

Selection

Type	Part No.	Tube Connection ODF	Nominal Capacity* Q _n kW			
			R 134a	R 404A / R 507	R 407C	R 22
PRC - 11A	800 384	16 mm - ⁵ / ₈ "	3,0	4,5	4,5	4,8
PRC - 11B	800 385	22 mm - ⁷ / ₈ "				
PRC - 21C	800 386	28 mm	7,4	11,1	11,1	11,9
PRC - 21D	800 387	1 - ¹ / ₈ "				
PRC - 21E	800 388	35 mm - 1 - ³ / ₈ "				

*Nominal capacities are based on evaporating temperature +4°C and condensing temperature +38°C and a pressure drop of 1 K.

Capacity Table

Selection for operating conditions other than +38°C / +4°C and 1 K liquid subcooling at the inlet of the valve:
(capacities are based on a pressure drop of 0,07 bar)

Refrigerant	Evaporating Temperature °C	Capacity (kW)													
		Valve Size 1: PRC-11x							Valve Size 2: PRC-21x						
		Valve setting °C													
		-20	-15	-10	-5	0	5	10	-20	-15	-10	-5	0	5	10
R 22	-29	2,3	3,4	4,4	4,8	4,9			5,8	8,8	10,0	10,0	10,0		
	-21		2,4	4,1	5,4	5,8				6,5	12,1	12,1	12,1		
	-14			2,7	4,9	6,2					8,1	13,8	13,8		
	-8				3,5	5,3						9,0	15,4		
	-3					3,1							9,9		
R 407 C	-6				3,1	4,8						7,9	13,9		
	-1					2,9							9,2		
R 134 a	-6					2,1	3,9	5,3					5,2	10,3	12,9
	1						2,4	4,7						6,1	12,2
	7							3,3							8,1
R 404A / R 507	-27	1,6	2,9	3,7	3,9				4,8	8,2	8,2	8,2			
	-20		1,9	3,5	4,5					5,7	9,8	9,8			
	-14			2,2	4,5						6,8	11,6			
	-10				3,1							8,1			

Pressure Controls and Thermostats

Pressure Controls

Basic Terms and Technical Information

Characteristics

Pressure controls serve various functions, which may be divided into control and protection functions. Examples for control functions are compressor cycling, pump-down or defrost control. Protection functions include, pressure limiting and cut out against excessive pressures, against loss of charge or for freeze protection.

These functions are performed by operating a set of electrical contacts when exceeding a preset lower or upper pressure limit. Depending on whether they are type tested (TÜV approved) or not they may be referred to by the following terms:

without TÜV approval:	Pressure Control
with TÜV approval:	Pressure Limiter, Pressure Cut Out or Safety Pressure Cut Out

Pressure controls with TÜV approval are tested according to EN 12263 as required by DIN 8901 and EN 378.

1. Pressure controls (without TÜV approval)

Pressure controls without type approval may either be of the automatic or manual reset type. Manual reset versions are available for decreasing (manual reset min.) or increasing pressure (manual reset max.)

2. Pressure limiters PSL/PSH

Pressure limiters are of the automatic reset type. Limiters for high pressure applications have a double bellows design to act as fail-safe controls.

3. Pressure cut outs PZH/PZL

Pressure cut outs are of the manual reset type where reset is possible from the outside of the control without the need for a tool (external reset). Cut outs for high pressure applications have a double bellows design to act as fail-safe controls.

4. Safety pressure cut outs PZHH/PZLL

Pressure cut outs are of the manual reset type where the reset requires the use of a tool. Typically, the removal of a cover is required in order to press the reset button (internal reset). Cut outs for high pressure applications have a double bellows design to act as fail-safe controls.

Adjustment of switching points

A pressure gauge should always be used for comparison when adjusting the switching points on pressure controls. The setting scale on the device is intended to serve for orientation, showing the setting range of the upper switching point p_{max} in bar/psig and the value of the pressure differential Δp as difference between upper switching point p_{max} and the lower switching point p_{min} . The upper switching point p_{max} has to be adjusted on the scale, whereas the lower switching point p_{min} is given by adjustment of the desired switching differential Δp .

The formula is:

$$\text{Upper switching point} - \text{Differential} = \text{Lower switching point}$$

$$P_{max} - \Delta p = P_{min}$$

Function of contacts SPDT

On pressure rise above setting 1-2 opens and 1-4 closes. On pressure drop below setting 1-2 closes and 1-4 opens.

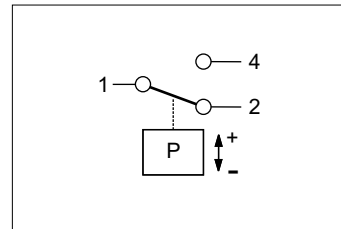

SPDT with manual reset max.

On pressure rise above setting 1-2 opens and 1-4 closes and latches. The device can be manually reset when the pressure has dropped below setting.

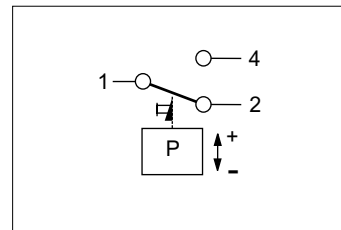

SPDT with manual reset min.

On pressure drop below setting 1-2 closes, 1-4 opens and latches. The device can be manually reset when the pressure has risen above setting.

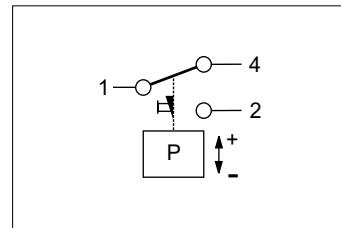

Unit of pressure

All pressures are given in gauge pressure

$$P_{absolute} = P_{gauge} + 1 \text{ bar}$$

$$1 \text{ bar} = 100 \text{ kPa}$$

$$1 \text{ bar} = 14.5 \text{ psi}$$

Pulsation damping

All high pressure controls with A-connection ($7/16$ -20UNF, $1/4$ " SAE male) are equipped with a snubber to protect the pressure element from pulsations.

Standards and Regulations

BGV D4 (VBG20)	Accident prevention regulations for refrigeration plant.
DIN 8901	Heat pumps with fluorocarbon refrigerants. Protection of soil, underground and surface water.
EN 60947-1/ EN 60947-5-1	Specifications for low-voltage switchgear.
EN 378	Refrigerating systems and heat pumps - Safety and environmental requirements.
EN 12263:	Refrigerating systems and heat pumps - Safety switching devices for limiting the pressure requirements and tests.

Selection Guide for Pressure Controls

Series	Selection Criteria						Catalogue Page
	Design	Number of Contacts (SPDT)	Adjustable	Protection DIN 40050 IEC 529	Rated Operational Current at 230 V AC		
					Inductive Amp. AC 15	Motor Rating UL	
PS1	Standard Model	1	yes	IP 44	10 A	24 A	106
PS2	Dual Pressure Switch	1 + 1	yes	IP 44	10 A	24 A	108
PS3	Pressure Switch Standard-Types	1	Factory set to fixed values	IP 30 / IP 65	3 A	6 A	110
PS3	Pressure Switch OEM-Types	1	Fixed values acc. to customer spec. depending on volume	IP 30 / IP 65	3 A	6 A	112
FD 113	Differential Pressure Switch	1	yes pressure diff. + time delay	IP 30	3 A / 6 A	—	113

Pressure Controls Series PS1 / PS2

Features

- Adjustable pressure range
- Automatic and manual reset versions
- Flare and solder connections
- Shatter resistant contacts
- High operational current, locked rotor max. 144 Amps (LRA)
- Standard SPDT with same operational current rating for both contacts
- Dual pressostat with two separate SPDT for high and low pressure side
- Adjustment screw sealable

Options

- Convertible reset to reduce stock
- Further pressure connections
- Factory set to customer specification



PS1



PS2

Standards

- per Low Voltage Directive
- per PED Directive 97/23 EG, TÜV appr. versions only
- Manufactured and tested to standards on our own responsibility
- US LISTED Underwriter Laboratories
- German Lloyd for use on ships, when equipped with marine-type cable gland

Technical Data PS1 / PS2

Type of Contacts	1 SPDT for PS1 2 separate SPDT for PS2	Protection acc. DIN 40050 / IEC 529	IP 44
Inductive Amp. (AC15)	10 A / 230V AC	Ambient Temperature Range	-50°C .. +70°C
Inductive Amp. (DC13)	0,1 A / 230V DC	Max. Temperature at Pressure Connection	+70°C
Motor Rating, Full Load Amp.	24 A / 120/240V AC	Vibration Resistance (10 to 1000 Hz)	4 g
Motor Rating, Locked Rotor Amp.	144 A / 120/240V AC	Cable Entry	Grommet PG 16
		Locking Device	Blocking Plate
		Mounting Screws	M4 / UNC 8-32

Single Pressure Controls PS1

Type	Part No.	Adjustment Range		Lowest Setpoint bar	Factory Setting bar	Leakage Test Pressure bar	Pressure Connection
		Upper Setpoint bar	Differential bar				

Low Pressure Controls

Part No.	Adjustment Range	Lowest Setpoint bar	Factory Setting bar	Leakage Test Pressure bar	Pressure Connection
PS1-A3A	4 370 700	-0.5 ... 7	3.5 / 4.5	25	7/16"-20 UNF
PS1-A3K	4 370 600				capillary/nut
PS1-A3L	4 714 945				cap./solder
PS1-A3U	4 712 201				solder 6 mm
PS1-A3X	4 713 430				solder 1/4"
PS1-R3A	4 350 100	-0.5 ... 7	3.5	25	7/16"-20 UNF
PS1-R3K	4 713 431				capillary nut
PS1-R3L	4 715 135				cap./solder
PS1-R3U	4 713 432				solder 6 mm
PS1-R3X	4 713 433				solder 1/4"

High Pressure Controls

Part No.	Adjustment Range	Lowest Setpoint bar	Factory Setting bar	Leakage Test Pressure bar	Pressure Connection
PS1-A5A	4 350 500	6 ... 31	16 / 20	36	7/16"-20 UNF
PS1-A5K	4 370 400				capillary/nut
PS1-A5L	4 715 136				cap./solder
PS1-A5U	4 713 325				solder 6 mm
PS1-A5X	4 713 434				solder 1/4"
PS1-R5A	4 350 700	6 ... 31	20	36	7/16"-20 UNF
PS1-R5K	4 370 300				capillary/nut
PS1-R5L	4 715 137				cap./solder
PS1-R5U	4 713 435				solder 6 mm
PS1-R5X	4 713 436				solder 1/4"

Single Pressure Controls Series PS1 TÜV / EN 12263

Type	Part No.	Adjustment Range		Lowest Setpoint bar	Factory Setting bar	Leakage Test Pressure bar	Pressure Connection
		Upper Setpoint bar	Differential Setpoint bar				

Pressure Limiter for Low Pressure Protection PSL - Automatic Reset

PS1-W3A	4 368 300	-0.5 ... 7	0.5 ... 5	-0.9	3.5 / 4.5	25	7/16"-20 UNF
PS1-W3K	4 321 400						capillary/nut
PS1-W3L	4 715 138						cap./solder
PS1-W3U	4 713 437						solder 6 mm
PS1-W3X	4 713 438						solder 1/4"

Pressure Cut Out for Low Pressure Protection PZL - External Reset

PS1-B3A	4 470 400	-0.5 ... 7	external reset approx. 1 bar above setpoint	-0.9	3.5	25	7/16"-20 UNF
PS1-B3K	4 715 139						capillary/nut
PS1-B3L	4 715 140						cap./solder
PS1-B3U	4 715 141						solder 6 mm
PS1-B3X	4 715 142						solder 1/4"

Pressure Limiter for High Pressure Protection PSH - Automatic Reset

PS1-W5A	4 353 200	6 ... 31	2 ... 15	3	16 / 20	36	7/16"-20 UNF
PS1-W5K	4 359 100						capillary/nut
PS1-W5L	4 715 143						cap./solder
PS1-W5U	4 713 439						solder 6 mm
PS1-W5X	4 713 440						solder 1/4"

Pressure Cut Out for High Pressure Protection PZH - External Manual Reset

PS1-B5A	4 353 300	6 ... 31	external reset approx. 3 bar under setpoint	-	20	36	7/16"-20 UNF
PS1-B5K	4 359 200						capillary/nut
PS1-B5L	4 715 144						cap./solder
PS1-B5U	4 712 332						solder 6 mm
PS1-B5X	4 713 441						solder 1/4"

Safety Pressure Cut Out for High Pressure Protection PZHH - Internal Manual Reset

PS1-S5A	4 368 400	6 ... 31	internal reset approx. 3 bar under setpoint	-	21	36	7/16"-20 UNF
PS1-S5K	4 359 400						capillary/nut
PS1-S5L	4 715 145						cap./solder
PS1-S5U	4 711 591						solder 6 mm
PS1-S5X	4 713 442						solder 1/4"



Dual Pressure Controls Series PS2

PS2

Type	Part No.	Adjustment Range				Factory Setting		Leakage Test Pressure		Pressure Connection
		Upper Setpoint left bar	right bar	Differential left bar	right bar	left bar	right bar	left bar	right bar	

Combined Low and High Pressure Controls

PS2-A7A	4 353 400	-0.5 ... 7	6 ... 31	0.5 ^a ... 5	ca. 4 fix	3.5 / 4.5	20	25	36	7/16"-20 UNF
PS2-A7K	4 350 900									capillary/nut
PS2-A7L	4 713 565									cap./solder
PS2-A7U	4 713 415									solder 6 mm
PS2-A7X	4 713 416									solder 1/4"
PS2-L7A	4 351 100	-0.5 ... 7	6 ... 31	0.5 ^a ... 5	external reset approx. 4 bar under setpoint	3.5 / 4.5	20	25	36	7/16"-20 UNF
PS2-L7K	4 370 500									capillary nut
PS2-L7L	4 440 800									cap./solder
PS2-L7U	4 713 417									solder 6 mm
PS2-L7X	4 713 418									solder 1/4"
PS2-R7A	4 351 300	-0.5 ... 7	6 ... 31	0.5 ^a ... 5	external reset approx. 1 bar above setpoint	3.5	20	25	36	7/16"-20 UNF
PS2-R7K	4 713 421									capillary nut
PS2-R7L	4 715 134									cap./solder
PS2-R7U	4 713 419									solder 6 mm
PS2-R7X	4 713 420									solder 1/4"

Dual Pressure Controls PS2 TÜV / EN 12263

Combined Pressure Limiter for Low Pressure / High Pressure Protection

PSL / PSH - automatic / automatic

PS2-W7A	4 360 100	-0.5 ... 7	6 ... 31	0.5 ^a ... 5	ca. 4 fix	3.5 / 4.5	20	25	36	7/16"-20 UNF
PS2-W7K	4 450 200									capillary/nut
PS2-W7L	4 450 300									cap./solder
PS2-W7U	4 712 436									solder 6 mm
PS2-W7X	4 713 429									solder 1/4"

Combined Pressure Limiter / Pressure Cut Out for Low Pressure / High Pressure Protection

PSL / PZH - automatic / external manual reset

PS2-C7A	4 353 500	-0.5 ... 7	6 ... 31	0.5 ^a ... 5	external reset approx. 4 bar under setpoint	3.5 / 4.5	20	25	36	7/16"-20 UNF
PS2-C7K	4 348 400									capillary/nut
PS2-C7L	5 715 131									cap./solder
PS2-C7U	4 713 422									solder 6 mm
PS2-C7X	4 713 423									solder 1/4"

Combined Pressure Limiter / Safety Pressure Cut Out for Low Pressure / High Pressure Protection

PSL / PZHH - automatic / internal manual reset

PS2-T7A	4 368 500	-0.5 ... 7	6 ... 31	0.5 ^a ... 5	internal reset approx. 4 bar under setpoint	3.5 / 4.5	21	25	36	7/16"-20 UNF
PS2-T7K	4 448 000									capillary/nut
PS2-T7L	4 715 132									cap./solder
PS2-T7U	4 713 424									solder 6 mm
PS2-T7X	4 713 425									solder 1/4"

^{a)} lowest possible setpoint: -0.9 bar

Dual Pressure Controls PS2 TÜV / EN 12263

Type	Part No.	Adjustment Range				Factory Setting		Leakage Test		Pressure Connection
		Upper Setpoint left bar	right bar	Differential left bar	right bar	Pressure left bar	right bar	Pressure left bar	right bar	

Combined Pressure Cut Out for Low Pressure / High Pressure Protection

PZL / PZH external manual reset / external manual reset

PS2-B7A	4 360 200	-0.5 ... 7	6 ... 31	external reset	external reset	3.5	20	25	36	$7/16$ "-20 UNF
PS2-B7K	4 446 600			approx.	approx.					capillary nut
PS2-B7L	4 446 700			1 bar above setpoint	4 bar under setpoint					cap./solder
PS2-B7U	4 449 400			solder 6 mm						
PS2-B7X	4 713 426			solder 1/4"						

Combined Pressure Cut Out / Safety Pressure Cut Out for High Pressure / High Pressure Protection

PZH / PZHH external manual reset / internal manual reset

PS2-G8A	4 368 600	6 ... 31	6 ... 31	external reset	internal reset	20	21	36	36	$7/16$ "-20 UNF
PS2-G8K	4 445 500			approx.	approx.					capillary/nut
PS2-G8L	4 715 133			4 bar under setpoint	4 bar under setpoint					cap./solder
PS2-G8U	4 713 427			solder 6 mm						
PS2-G8X	4 713 428			solder 1/4"						

Accessories

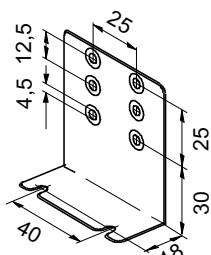

**Mounting
bracket angle**
Part No.: 803 799

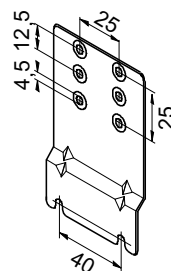

**Mounting plate for
units with hood**
Part No.: 803 801

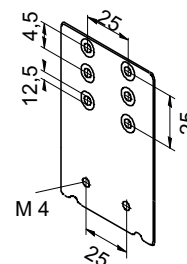

Extension bracket
Part No.: 803 800

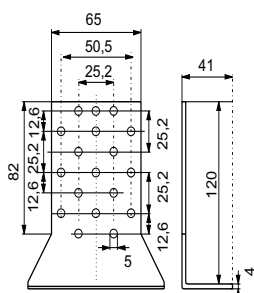

**Universal
mounting
bracket**
Part No.: 803 798

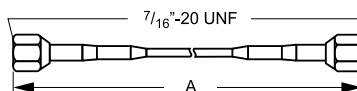

**Capillary Tube with two
flare nuts $7/16$ "-20 UNF, R $1/4$ "**
1,5m
Part No.: 803 804

Copper Gasket Set for R $1/4$ "
($7/16$ "-20 UNF, female)
100 pcs package
Part No.: 803 780

Pressure Controls Series PS3 / Standard types

Compact Pressure Switch with fixed switch-point settings

Features

- **Maximum operating pressure up to 43 bar / test pressure up to 48 bar**
- Standard factory settings from stock in small volumes
- High and low pressure switches
- High temperature version with snubber for direct compressor mounting (range 6)
- Direct mounting reduces the number of joints and thus avoiding potential leakage
- Precise setting and repeatability
- IP 65 protection if used with PS3-Nxx and PS3-Lxx cables with plug (acc. EN 175301-803), no additional gasket required (molded into plug)
- Cables with plug to be ordered separately



PS3

Standards

- per Low Voltage Directive
- per PED Directive 97/23 EG, TÜV appr. versions only
- Manufactured and tested to standards on our own responsibility
- Underwriter Laboratories

Technical Data

Protection acc. to DIN 40050 / IEC 529	IP 00 IP 30 with terminal cover IP 65 with PS3-Nxx/-Lxx cables with plug or Plug DIN 43650	Temperature range TS * ambient, storage and transportation medium	-40 °C .. 70 °C -40 °C .. 70 °C (150°C range 6)
Inductive Amp. (AC)	3A / 230V AC	Pressure Range PS	- 0,6 .. 43 bar
Inductive Amp. (DC)	0.1A / 230V DC	Vibration resistance (10..1000 Hz)	4 g
Motor rating, full load Amp.	6A / 120/240V AC	Type of contacts	1 SPDT
Motor rating, locked rotor Amp.	36A / 120/240V AC	Medium compatibility	HFC, HCFC

*) Note: For high temperature applications, i. e. medium temperatures between 70 °C and 150 °C, the maximum ambient temperature must be derated as per drawing.
E.g.: on medium temperature 120 °C the ambient temperature of 55 °C around the switch housing should not be exceeded.

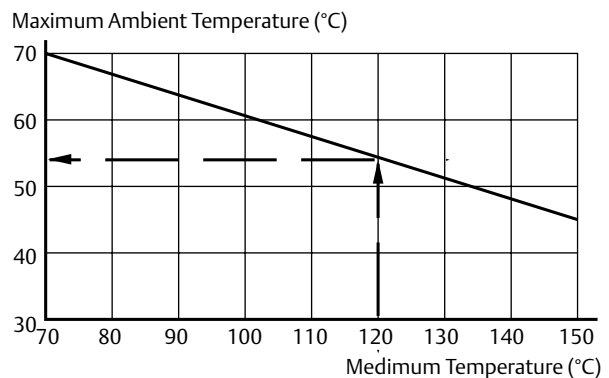

Pressure Controls Series PS3 / Standard types

Pressure Control Type	Part No.	Fixed setting		Reset	Max. Temperature		Leakage Test Press. bar	Pressure Connection
		Cut out bar	Cut in bar		Ambient °C	Pressure °C		

High Pressure Controls

PS3-A6S	0 715 603	16,0	11,0	auto	+70	+150	48	7/16"-20UNF female thread with Schrader opener
PS3-A6S	0 715 604	19,0	15,0					
PS3-A6S	0 715 600	26,5	22,5					

Low Pressure Controls / Pressure Limiter for low pressure protection PSL TÜV / EN 12263

PS3-W1S	0 714 760	-0,3	1,2	auto	+70	+70	30	7/16"-20UNF female thread with Schrader opener
PS3-W1S	0 714 761	0,3	1,8					
PS3-W1S	0 714 762	2,0	3,5					

Pressure Limiter for high pressure protection PSH TÜV / EN 12263

PS3-W6S	0 715 831	14,0	10,0	auto	+70	+150	48	7/16"-20UNF female thread with Schrader opener and snubber
PS3-W6S	0 715 556	21,0	16,0					
PS3-W6S	0 715 555	25,0	20,0					
PS3-W6S	0 715 567	29,0	23,0					
PS3-W6S	0 715 550	33,5	27,5					
PS3-W6S	0 715 553	40,0	33,0					

Pressure Cut Out for high pressure protection PZH with snubber for direct compressor mounting TÜV / EN 12263

PS3-B6S	0 715 568	19,2	approx. 5 bar below cut-out	external manual reset	+70	+150	48	7/16"-20UNF female thread with Schrader opener and snubber
PS3-B6S	0 715 564	22,7						
PS3-B6S	0 715 563	27,3						
PS3-B6S	0 715 569	29,5						
PS3-B6S	0 715 560	36,0						

Selection Chart Cable Assemblies

Temperature Range -25 to 80°C / no UL		Temperature Range -50 to 80°C / UL appr.		Length (mtr.)	Leads
Type	Part No.	Type	Part No.		
PS3-N15	804 580	PS3-L15	804 583	1.5	3 x 0.75 mm ²
PS3-N30	804 581	PS3-L30	804 584	3.0	
PS3-N60	804 582	PS3-L60	804 585	6.0	



Accessories

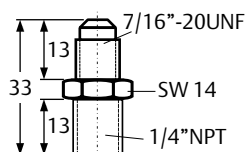

Adapter 1/4" NPT male - 7/16"-20UNF - male
for compressor direct mounting
Part No.: 800 315

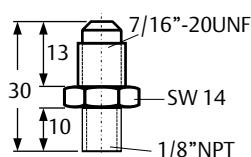

Adapter 1/8" NPT male - 7/16"-20UNF - male
for compressor direct mounting
Part No.: 800 316

Pressure Controls Series PS3 / Special types

For OEM use with settings according to customer's specification, minimum order quantity 100 pcs.

Features

- **Maximum Operating Pressure up to 43 bar / Test Pressure up to 48 bar**
- For direct mounting on a pressure connection (free standing) or with a capillary tube
- Direct mounting reduces the number of joints and thus avoiding potential leakage
- Direct mounting saves cost for flexible hose and additional fittings
- Precise setting and repeatability
- High temperature version with snubber, for direct compressor mounting (range 6)
- Micro switch for narrow pressure differentials
- Gold plated contacts for low voltage / current applications
- Worldwide approvals
- Easy mounting

Options

- Low pressure switch with automatic or manual reset
- High pressure switch with automatic or manual reset, standard or high temperature version
- Pressure limiter PSH - standard or high temperature version
- Pressure cut-out PZH - external reset, standard or high temperature version
- Safety pressure cut-out PZHH - internal reset, standard or high temperature version

Electrical connections (optional)

- Cables with plug in lengths of 1.5m, 3.0m and 6.0m available. No additional gasket required.
- Appliance socket DIN 43650

Type of contacts (optional)

- Standard (SPDT)
- Micro switch (SPDT)
- Gold plated contacts upon request



PS3

Standards

- per Low Voltage Directive
- per PED Directive 97/23 EG, TÜV appr. versions only
- Manufactured and tested to standards on our own responsibility
- Underwriter Laboratories

Pressure connections

- S: $\frac{7}{16}$ "-20UNF, female with Schrader opener and snubber (snubber only with high temperature diaphragm)
- A: $\frac{7}{16}$ "- 20UNF, $\frac{1}{4}$ " SAE male
- U: 6 mm solder, 80 mm length, ODF
- X: $\frac{1}{4}$ " solder, 80 mm length, ODF
- K: 1 m capillary tube with $\frac{1}{4}$ " SAE flare nut and Schrader opener
- L: 1 m capillary tube and $\frac{1}{4}$ " ODM solder connector

Installation

- Depending on pressure connection, free-standing or with console.

Technical Data

Protection acc. to DIN 40050 / IEC 529	IP 00 IP 30 with terminal cover IP 65 with PS3-Nxx/-Lxx cables with plug or Plug DIN 43650
Inductive Amp. (AC15)	3 A / 230V AC 1.5 A with microswitch standard 0.1 A with gold plated contacts
Inductive Amp. (DC)	0.1 A / 230V DC
Motor rating, full load Amp.	6 A / 120/240V AC 2.5 A with microswitch
Motor rating, locked rotor Amp.	36 A / 120/240V AC 15 A with microswitch

Temperature range TS * ambient, storage and transportation medium	see temp. deration page 110 -40 °C .. 70 °C -40 °C .. 70 °C (150°C range 6)
Pressure Range PS	- 0.6 .. 43 bar
Vibration resistance	4 g (10 to 1000 Hz)
Type of contacts	1 SPDT
Medium compatibility	HFC, HCFC
Available approvals	TÜV, UL
Weight (approx.)	0.1 kg

For more information see datasheet PS3_e35003.

Differential Pressure Controls Series FD 113

Features

- Immediate reset (no cooling down period)
- Precise timing
- Adjustable time delay from 20 to 150 sec (ZU types)
- Separate output signals for operation and alarm
- Suitable for supply voltage 24 to 240 V AC / V DC
- Pressure connection: Flare $\frac{7}{16}$ "-20 UNF, $\frac{1}{4}$ " SAE male

Standards

- per Low Voltage Directive
- Manufactured and tested to standards on our own responsibility



FD 113

Differential Pressure Controls Type	Part No.	Time Delay		Cut out		Cut in Fixed Setting bar	Max. Differential Pressure bar	Max. Proof Pressure bar
		adjustable Sec.	Factory Setting Sec.	Adjusting Range Δp bar	Factory Setting bar			
FD 113	0 710 173	—	—	0.3 ... 4.5	0.7	0.2 above cut out	-0,8 ... 12	25
FD 113 ZU	3 465 300	20 ... 150	120					
FD 113 ZU (A22-057) Copeland-Version	0 711 195	—	115 fix	—	0.63 fix	appr. 0.9		

Technical Data

Inductive Amp. (AC)	3.0 A / 230 V AC
Inductive Amp. (DC)	0.1 A / 230 V DC
Protection acc. to EN 60 529	IP 30
Nominal Voltage FD 113 ZU	24 ... 240V AC / DC

Ambient Temperature Range	-20°C to +70°C
Max. Temperature at Pressure Connection	+70°C
Vibration resistance (10 to 1000 Hz)	4 g

Accessories

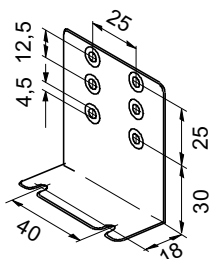

Mounting bracket angle
Part No.: 803 799

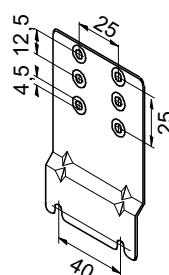

Mounting plate for units with hood
Part No.: 803 801

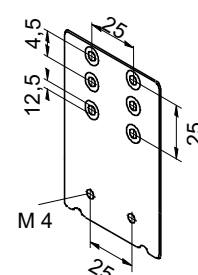

Extension bracket
Part No.: 803 800

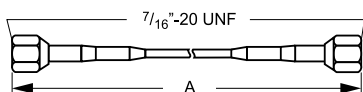

Capillary Tube with two flare nuts $\frac{7}{16}$ "-20 UNF, R $\frac{1}{4}$ "
1,5m
Part No.: 803 804

Copper Gasket Set for R $\frac{1}{4}$ " ($\frac{7}{16}$ "-20 UNF, female)
100 pcs package
Part No.: 803 780

Thermostats

Basic Terms and Technical Information

Characteristics

ALCO thermostats are electric circuit control devices which open or close an electric contact depending on temperature changes at the bulb.

Description of bulb charges

The application range of thermostats is mainly determined by the charge. Accordingly various bulb shapes and sizes are necessary.

- **Vapour charge, bulb type A, E, P**

The thermosystem is filled with a medium in vapour phase. A thermostat with vapour charge operates in accordance with temperature changes at the bulb as long as the bulb is the coldest part in the whole system (bellows, capillary tube, bulb). ALCO thermostats are equipped with a bellows heater (82 k Ohm, 230 V) to avoid such conditions. On applications with low current the bellows heater has to be removed. Max. bulb temperature is 150°C (70°C for bulb type E). Response time is very fast.

- **Liquid charge**

Bulb type C: Bulb must be warmer than capillary tube and bellow (i.e. for heating purpose). Max. bulb temperature is 210°C. Response time is fast.

- **Adsorption charge, bulb type F**

This charge only reacts on temperature changes at the bulb. Max. bulb temperature is 100°C. Response time is slow but perfectly suitable for common refrigeration systems.

Adjustment of switching points

A thermometer should always be used for comparison when adjusting the switching points on temperature controls. The setting scale on the device is intended to serve for orientation, showing the setting range of the upper switching point t_{max} in °C and °F and the value of the temperature differential Δt in K as difference between the upper switching point t_{max} and the lower switching point t_{min} . The upper switching point t_{max} has to be adjusted on the scale, whereas the lower switching point t_{min} is given by adjustment of the desired switching differential Δt . The formula is:

$$\text{Upper switching point} - \text{Differential} = \text{Lower switching point}$$

$$t_{max} - \Delta t = t_{min}$$

Important!

The differential Δt mentioned on the differential scale and in the technical data refers to the upper part of the setting range and the upper switching point. In the lower part of the setting range an increase of the differential Δt can be expected. The lowest possible lower switching point t_{min} is mentioned in the selection tables and is helpful to select switching points with large differentials Δt in the lower temperature range.

Bulb Sizes

A	E	P	C	F
Vapour 2m, capillary with bulb	Vapour coil, 0m	Vapour 2m, capillary with function C and D 6m	Liquid 2m, capillary with bulb	Adsorption 2m, capillary with bulb

Function of contacts

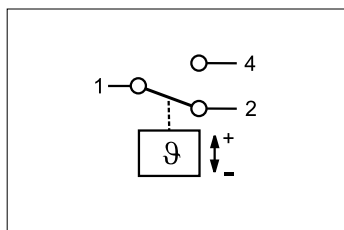

SPDT

- On temperature rise above setting 1-2 opens and 1-4 closes.
- On temperature drop below setting 1-2 closes and 1-4 opens.

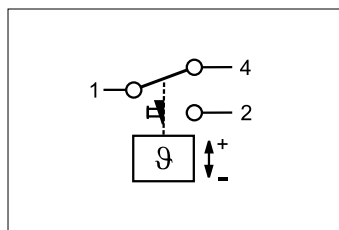

SPDT with manual reset min.

- On temperature drop below setting 1-2 closes, 1-4 opens and latches.
- The device can be manually reset when the temperature has risen at least 2K above setting.

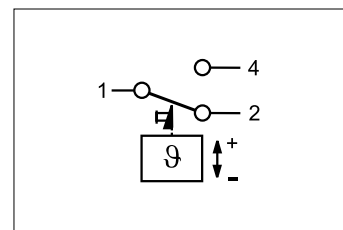

SPDT with manual reset max.

- On temperature rise above setting 1-2 opens and 1-4 closes and latches.
- The device can be manually reset when the temperature has dropped 2K below setting.

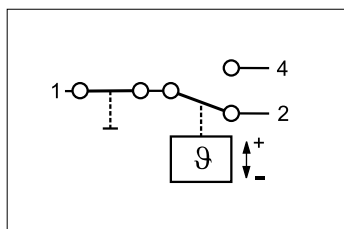

SPDT with off switch AUTOmatic - STOP

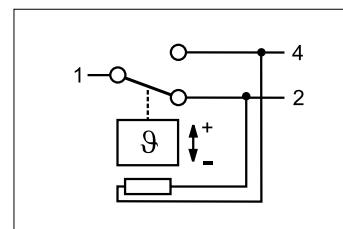

SPDT with bellows heater includes a 82 k Ohm, 230 V AC/DC resistor

Standards and regulations

Important for the installation of thermostats:

EN 60730-2-9 Specification for temperature controls and temperature cut-outs.

EN 60947-1/ Specifications for low-voltage
EN 60947-5-1 switchgear.

EN 378: Refrigerating systems and heat-pumps. Safety and environmental requirements.

Thermostats Series TS1

Features

- Adjustable temperatures and differentials
- Shatter resistant contacts
- High operational current, locked rotor max. 144 Amps (LRA)
- Standard SPDT with same operational current rating for both contacts
- Captive terminal and cover screws
- Range and differential individually lockable



TS1 Top Operated



TS1 Flush Mounted



TS1 Front Operated

Technical Data

Type of Contacts	1 SPDT
Inductive Amp. (AC15)	10 A / 230 V AC
Inductive Amp. (DC13)	0.1 A / 230 V DC
Heating load (AC1)	24 A / 230 V AC
Motor Rating, Full Load Amp.	24 A / 120/240V AC
Motor Rating, Locked Rotor Amp.	144 A / 120/240V AC
Ambient Temperature Range	-50°C to +70°C
Vibration Resistance (10 to 1000 Hz)	4 g
Cable Entry	Grommet PG 16
Protection acc. to	IP 44 (IP 30 with Selector Switch)
DIN 40050 / IEC 529	
Bellows Heater at Vapour Charge	82 K Ohm, 230 V AC / DC (12 and 24 V DC upon request)

Standards

- per Low Voltage Directive
- Manufactured and tested to standards on our own responsibility
- US LISTED Underwriter Laboratories

Type	Part No.	Adjustment Range		Lowest Setpoint	Factory Setting	Max. Bulb Temp.	Temperature Sensor	
		Upper Setpoint	Differential Setpoint ΔT				Charge	Cap. tube length
		°C	K	°C	°C	°C		

Thermostats Top Operated

Thermostats without Off-Switch

Type	Part No.	Adjustment Range	Differential Setpoint ΔT	Lowest Setpoint	Factory Setting	Max. Bulb Temp.	Temperature Sensor Charge	Cap. tube length
TS1-A2P	4 530 400	-30 ... +15	1.5 ... 16	-36	-1 / -6	+150	Vapour	2m capillary
TS1-R2P	4 715 170	-30 ... +15	man. reset ca. 2.5 fix	-32	+2			
Low temp cut out								
TS1-A3P	4 356 700	-10 ... +35	1.5 ... 16	-23	+3 / -2	+150	Vapour	2m capillary and bulb
TS1-A1A	4 351 500	-45 ... -10	1.5 ... 16	-55	-18 / -20			
TS1-A2A	4 351 600	-30 ... +15	1.5 ... 16	-36	-1 / -6			
TS1-A3A	4 352 500	-10 ... +35	1.5 ... 16	-23	+3 / -2			
TS1-A4F	4 351 800	-30 ... +35	2.8 ... 20	-35	+5 / 0			
Defrost- and Universal Thermostat						+100	Adsorption	
TS1-A5F	4 458 400	+20 ... +60	3 ... 10	+10	+35 / +30			

Thermostats with Off-Switch

Type	Part No.	Adjustment Range	Differential Setpoint ΔT	Lowest Setpoint	Factory Setting	Max. Bulb Temp.	Temperature Sensor Charge	Cap. tube length
TS1-B1A	4 366 700	-45 ... -10	1.5 ... 16	-55	-18 / -20	+150	Vapour	2m capillary and bulb
TS1-B2A	4 366 800	-30 ... +15	1.5 ... 16	-36	-1 / -6			
TS1-B3A	4 366 900	-10 ... +35	1.5 ... 16	-23	+3 / -2			
TS1-B4F	4 367 000	-30 ... +35	2.8 ... 20	-35	+5 / 0	+100	Adsorption	

Frost Monitors Top Operated

Frost Monitors without Off-Switch

Type	Part No.	Adjustment Range	Differential Setpoint ΔT	Lowest Setpoint	Factory Setting	Max. Bulb Temp.	Temperature Sensor Charge	Cap. tube length
TS1-C0P	4 352 100	+4.5 ... +20	2.5 fix	+2	4.5 / +2	+150	Vapour	6m capillary
TS1-D0P	4 352 200	+4.5 ... +20	man. reset ca. 2.5 fix	+2	+2			
Low temp. cut out								

Type	Part No.	Adjustment Range		Lowest Setpoint °C	Factory Setting °C	Max. Bulb Temp. °C	Temperature Sensor	
		Upper Setpoint °C	Differential Setpoint ΔT K				Charge	Cap. tube length

Room Thermostats Top Operated

Room Thermostats without Off-Switch, including insulation console

TS1-A1E	4 362 800	-45 ... -10	1.5 ... 16	-55	-18 / -20	+70	Vapour	0m coil
TS1-A2E	4 355 200	-30 ... +15		-36	+4 / +2			
TS1-A3E	4 355 300	-10 ... +35		-23	+20 / +18			

Room Thermostats with Off-Switch, including insulation console

TS1-B1E	4 344 300	-45 ... -10	1.5 ... 16	-55	-18 / -20	+70	Vapour	0m coil
TS1-B2E	4 344 400	-30 ... +15		-36	+4 / +2			
TS1-B3E	4 344 500	-10 ... +35		-23	+20 / +18			

Thermostats Front Operated

Thermostats without Off-Switch

TS1-E1A	4 361 000	-45 ... -10	2 ... 16	-55	-18 / -20	+150	Vapour	2m capillary and bulb
TS1-E2A	4 356 200	-30 ... +10	1.5 ... 15	-36	+4 / +2			
TS1-E3A	4 365 200	-10 ... +25	1.5 ... 15	-23	+3 / -2			
TS1-E4F	4 367 500	-25 ... +30	2.8 ... 20	-30	+5 / 0	+100	Adsorption	
Defrost- and universal thermostat								
TS1-E5F	4 338 100	+20 ... +60	3 ... 10	+10	+35 / +30			
TS1-E7F	4 367 600	+0 ... +10	2.5 fix	-2.5	+5.5 / +3	Milk and beer cooler thermostat		

Thermostats with Off-Switch

TS1-F1A	4 367 100	-45 ... -10	2 ... 16	-55	-18 / -20	+150	Vapour	2m capillary and bulb
TS1-F2A	4 367 200	-30 ... +10	1.5 ... 15	-36	-1 / -6			
TS1-F3A	4 367 400	-10 ... +25	1.5 ... 15	-23	+3 / -2			

Room Thermostats Front Operated

Room Thermostats without Off-Switch, including insulation console

TS1-E1E	4 365 300	-45 ... -10	2 ... 16	-55	-18 / -20	+70	Vapour	0m coil
TS1-E2E	4 356 800	-30 ... +10	1.5 ... 15	-36	+4 / +2			
TS1-E3E	4 356 900	-10 ... +25	1.5 ... 15	-23	+20 / +18			

Room Thermostats with Off-Switch, including insulation console

TS1-F1E	4 368 000	-45 ... -10	2 ... 16	-55	-18 / -20	+70	Vapour	0m coil
TS1-F2E	4 368 100	-30 ... +10	1.5 ... 15	-36	+4 / +2			
TS1-F3E	4 368 200	-10 ... +25	1.5 ... 15	-23	+20 / +18			
TS1-F4E	4 465 000	0 ... +40	2 ... 16	-7	+20 / +18			

Thermostats for Flush Mounting

Thermostats for Flush Mounting without Off-Switch

TS1-G1A	4 364 700	-45 ... -10	1.5 ... 15	-55	-18 / -20	+150	Vapour	2m capillary and bulb
TS1-G2A	4 355 400	-30 ... +15	1.5 ... 15	-36	+4 / +2			
TS1-G3A	4 364 800	-10 ... +35	1.5 ... 15	-23	+20 / +18			
TS1-G4F	4 355 600	-30 ... +35	2.8 ... 20	-35	+5 / 0	Adsorption	bulb	
Defrost- and universal thermostat								
TS1-G7F	4 356 000	0 ... +10	2.5 fix	-2.5	+5.5 / +3			
Milk and beer cooler thermostat								

Thermostats for Flush Mounting with Off-Switch

TS1-H1A	4 364 600	-45 ... -10	1.5 ... 15	-55	-18 / -20	+150	Vapour	2m capillary and bulb
TS1-H2A	4 355 500	-30 ... +15	1.5 ... 15	-36	-1 / -6			
TS1-H3A	4 367 900	-10 ... +35	1.5 ... 15	-23	+3 / +2			
TS1-H4F	4 355 800	-30 ... +35	2.8 ... 20	-35	+5 / 0	+100	Adsorption	
TS1-H7F	4 365 500	0 ... +10	2.5 fix	-2.5	+5.5 / 3			
Milk and beer cooler thermostat								

Thermostats for flush mounting are delivered with mounting angle Order No. 803 805.

Accessories & Spare Parts

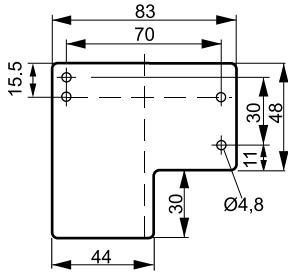

Insulation Console
for Room Thermostats standard
Part No.: 803 777

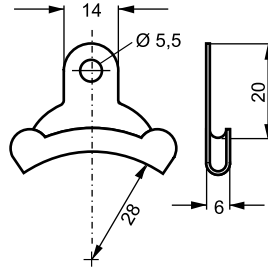

Capillary Tube Holder
for Frost Monitors standard
Part No.: 803 778

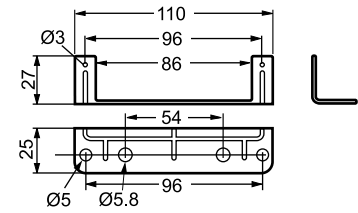

Mounting angle
for TS1-Gxx / TS1-Hxx
Part No.: 803 805

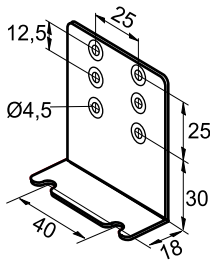

Mounting bracket angle
Part No.: 803 799

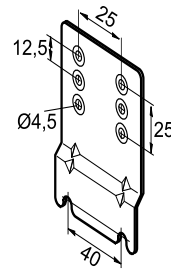

Mounting plate
for units with hood
Part No.: 803 801

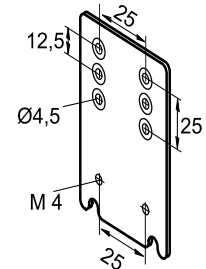

Extension bracket
Part No.: 803 800

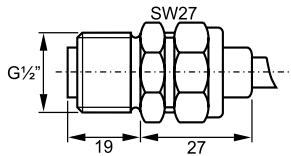

Capillary Tube Gland, Brass
for Bulb Style A / C
Part No.: 803 807

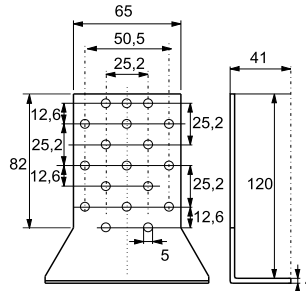

Universal mounting bracket
Part No.: 803 798

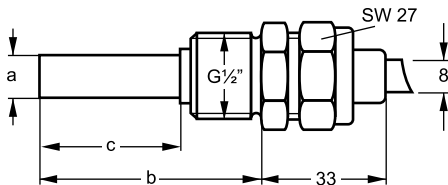

Sensing Bulb Wells

Dimensions in mm

for Bulb	Part No.	Ø a	c	b
A	803 808	14.0	47.0	66.0
C	803 809	14.0	37.0	56.0
F	803 810	12.0	66.5	86.0

System Protectors, Moisture Indicators

Filter Driers

Basic Terminology and Technical Information

Function

The purpose of filter driers is to keep the refrigeration circuit clean of water, acid and solid contaminants. In case of contamination, corrosion and ice building can occur, as well as malfunction of the compressor.

Property of desiccants

Molecular sieves

This kind of desiccant has a very good drying effect independent of the oil content of the refrigerant. Molecular sieve is a fast acting desiccant and will remove moisture even when the water content of the refrigerant is low and when the temperature of the liquid refrigerant is high.

Activated alumina

Activated alumina incorporate an excellent acid capacity.

By selecting a specific mixture of both desiccants an optimum effect can be achieved to cover the requirements of all kinds of applications. Liquid filter driers are especially designed for a high water capacity whereas suction line filter driers feature a high acid and filtration capacity.

Flow capacity

Flow capacity refers to ARI-Standard 710-86 and DIN 8949 and is based on a pressure drop of 0.07 bar, +30°C liquid temperature and -15°C evaporating temperature for common refrigerants.

The flow capacities are given at two levels of pressure drop: 0.07 and 0.14 bar.

For Filter drier selection under other operating conditions use the correction factors on page 129/130.

Water capacity

The water capacity for R 22 refers to ARI 710-86 and DIN8948 is based on a liquid temperature of 24/52°C and an equilibrium point dryness (EPD) of 60 PPM water in refrigerant. The EPD for other refrigerants according to DIN 8949 is as follows:

Refrigerant	EPD (PPM)
R 134a	50
R 407C	50
R 404A	50
R 507	50
R 410A	50

Selection Guide for Filter and Filter Driers

Selection criteria	Series												
	BFK	ADK-Plus	FDB	ADKS with core H/S/W48		FDS48 with core H/S/W48		FDS-24 with core S24		ASF	ASD	BTAS with core AF	
				F48	F48	F24	F24					AF-D	
Hermetic design	+	+	+							+	+		
For exchangeable cores				+	+	+	+	+	+			+	+
Quick cap flange						+	+	+	+				
Filter					+		+		+	+		+	
Filter drier	+	+	+	+		+		+			+		+
For liquid service	+	+	+	+		+		+					
For suction service					+		+	+	+	+	+	+	+
For Heat Pumps (Bi-Flow)	+												
Shell material	Steel	Steel	Steel	Steel		Steel		Steel		Steel	Steel	Brass	
Catalogue page	121	122	124	126		128		127		131	131	132	

Bi-flow Filter Driers Series BFK

Features

- Solid block style
- Integrated check valves insure Bi-flow capability, eliminate the need for external check valves and reduce the external piping
- ODF Copper fittings for easy soldering
- Pattern flow for non-turbulent performance
- High water, acid adsorption capacity
- Temperature range TS: -40°C to +65°C
- Max. operating pressure PS: 43 bar
- No CE marking according art. 3.3 PED 97/23 EC
- HP marking according to German Pressurized Vessel Directive
- Underwriter Laboratories



BFK

Type	Part No.	Connection size & type	Nominal Flow Capacity (kW)									
			at 0.07bar pressure drop					at 0.14 bar pressure drop				
			R 134a	R 22	R 407C	R 404A R 507	R 410A	R 134a	R 22	R 407C	R 404A R 507	R 410A
BFK-052	007 343	1/4" (6mm) SAE	5.2	5.7	5.4	3.7	5.6	8.0	8.8	8.4	5.7	8.7
BFK-052S	007 344	1/4" ODF	6.7	7.3	7.0	4.8	7.2	10.1	11.1	10.6	7.2	10.9
BFK-083	007 345	3/8" (10mm) SAE	10.6	11.5	11.0	7.5	11.4	16.9	18.4	17.6	12.0	18.2
BFK-083S	007 346	3/8" ODF	12.0	13.1	12.5	8.5	12.9	20.6	22.5	21.5	14.7	22.2
BFK-084	007 347	1/2" (12mm) SAE	15.2	16.6	15.8	10.8	16.4	25.8	28.1	26.8	18.3	27.8
BFK-084S	007 348	1/2" ODF	15.6	17.0	16.2	11.1	16.8	28.7	31.3	29.9	20.4	30.9
BFK-163	007 349	3/8" (10mm) SAE	13.6	14.9	14.2	9.7	14.7	21.0	22.9	21.8	14.9	22.6
BFK-163S	007 350	3/8" ODF	15.5	16.9	16.1	11.0	16.7	23.8	26.0	24.8	17.0	25.7
BFK-164	007 351	1/2" (12mm) SAE	20.3	22.1	21.1	14.4	21.9	27.5	30.0	28.6	19.6	29.6
BFK-164S	007 352	1/2" ODF	24.3	26.5	25.3	17.3	26.1	34.4	37.6	35.9	24.5	37.1
BFK-165	007 353	5/8" (16mm) SAE	25.1	27.4	26.2	17.9	27.1	35.3	38.5	36.8	25.1	38.0
BFK-165S	007 354	5/8" ODF	25.6	28.0	26.7	18.3	27.6	37.0	40.4	38.5	26.3	39.9
BFK-305	007 355	5/8" (16mm) SAE	26.4	28.8	27.5	18.8	28.5	41.6	45.4	43.3	29.6	44.8
BFK-305S	007 356	5/8" (16mm) ODF	34.1	37.3	35.6	24.3	36.8	52.8	57.7	55.0	37.6	56.9
BFK-307S	007 357	7/8" (22mm) ODF	40.6	44.3	42.3	28.9	43.7	65.7	71.7	68.4	46.8	70.8
BFK-309S	007 358	1 1/8" ODF	47.0	51.3	49.0	33.5	50.7	79.9	87.2	83.2	56.9	86.1

The rated flow capacities are in accordance with ARI standard 710-86 and DIN 8949 at +30°C liquid temperature and -15°C evaporating temperature.

Selection method for other conditions:

1. Determine the correction factor (page 129) based on type of refrigerant, liquid and evaporating temperature.
2. Multiply the correction factor by cooling capacity or heating capacity whatever is more.
3. Select the filter drier according to determined capacity corresponding to flow capacity at 0.07 bar pressure drop.

Water and Acid Adsorption Capacity

Type	Water adsorption capacity (gram)										Acid Adsorption Capacity (g)
	Liquid Temperature 24°C					Liquid Temperature 52°C					
	R 134a	R 22	R 404A / R 507	R 407C	R 410A	R 134a	R 22	R 404A / R 507	R 407C	R 410A	
BFK-05...	4.4	4.1	4.5	3.4	2.8	4.1	3.8	4.3	2.8	2.2	0.3
BFK-08...	9.6	9.0	9.9	7.5	6.2	8.9	8.2	9.4	6.0	4.7	0.6
BFK-16...	18.9	17.7	19.5	14.8	12.2	17.5	16.2	18.5	11.9	9.3	1.2
BFK-30...	34.5	32.3	35.6	27.1	22.4	31.9	29.6	33.7	21.7	17.0	2.0

Filter Driers Series ADK-Plus

Hermetic Design, for Liquid Refrigerants

Features

- Robust block with optimum blend of molecular sieve and activated alumina
- ODF Copper fittings for easy soldering
- High water and acid capacity
- Filtration down to 20 micron
- Temperature range TS: -40°C to +65°C
- Max. working pressure PS: 43 bar
- No CE marking according art. 3.3 PED 97/23 EC
- HP marking according to German Pressurized Vessel Directive
- US LISTED Underwriter Laboratories



ADK-Plus

Type	Part No.	Nominal Flow Capacity (kW)											
		at 0.07 bar pressure drop						at 0.14 bar pressure drop					
		R 22	R 134a	R 404A R 507	R 407C	R 410A	R 744	R 22	R 134a	R 404A R 507	R 407C	R 410A	R 744
ADK-032	003 595	7,3	6,7	4,8	7,0	7,2	8,2	10,6	9,7	6,9	10,1	10,5	11,9
ADK-036MMS	003 597	8,0	7,3	5,2	7,6	7,9	9,0	12,0	11,0	7,8	11,4	11,8	13,5
ADK-032S	003 596	8,8	8,1	5,7	8,4	8,7	9,9	12,9	11,8	8,4	12,3	12,7	14,5
ADK-052	003 598	7,6	6,9	4,9	7,2	7,5	8,5	11,0	10,1	7,2	10,5	10,9	12,4
ADK-056MMS	003 600	10,0	9,2	6,5	9,5	9,9	11,2	15,0	13,7	9,8	14,3	14,8	16,8
ADK-052S	003 599	10,8	9,9	7,0	10,3	10,7	12,1	17,1	15,6	11,1	16,3	16,9	19,2
ADK-053	003 601	14,2	13,0	9,2	13,5	14,0	15,9	21,3	19,5	13,9	20,3	21,0	23,9
ADK-0510MMS	003 603	16,4	15,0	10,7	15,6	16,1	18,4	24,1	22,1	15,7	23,0	23,8	27,1
ADK-053S	003 602	16,4	15,0	10,7	15,6	16,1	18,4	24,1	22,1	15,7	23,0	23,8	27,1
ADK-082	003 604	7,8	7,1	5,1	7,4	7,7	8,7	11,3	10,4	7,4	10,8	11,2	12,7
ADK-086MMS	003 606	10,7	9,8	7,0	10,2	10,5	12,0	16,0	14,7	10,4	15,3	15,8	18,0
ADK-082S	003 605	11,9	10,9	7,8	11,4	11,8	13,4	17,3	15,9	11,3	16,5	17,1	19,4
ADK-083	003 607	16,4	15,0	10,7	15,6	16,2	18,4	23,9	21,9	15,6	22,8	23,6	26,9
ADK-0810MMS	003 609	16,4	15,0	10,7	15,6	16,2	18,4	24,1	22,1	15,7	23,0	23,8	27,1
ADK-083S	003 608	16,4	15,0	10,7	15,7	16,2	18,4	24,1	22,1	15,7	23,0	23,8	27,1
ADK-084	003 610	25,7	23,5	16,7	24,5	25,3	28,8	39,1	35,8	25,5	37,3	38,6	43,9
ADK-0812MMS	003 612	26,3	24,1	17,2	25,1	26,0	29,6	39,5	36,2	25,8	37,7	39,0	44,3
ADK-084S	003 611	26,8	24,5	17,5	25,6	26,4	30,1	40,4	37,0	26,3	38,5	39,8	45,3
ADK-162	003 613	8,0	7,3	5,2	7,6	7,8	8,9	11,5	10,5	7,5	10,9	11,3	12,9
ADK-163	003 614	16,8	15,4	10,9	16,0	16,5	18,8	24,1	22,1	15,7	23,0	23,8	27,1
ADK-1610MMS	003 616	18,7	17,1	12,2	17,8	18,5	21,0	26,8	24,5	17,5	25,6	26,5	30,1
ADK-163S	003 615	18,7	17,2	12,2	17,9	18,5	21,0	26,8	24,5	17,5	25,6	26,5	30,1
ADK-164	003 617	31,3	28,7	20,4	29,9	30,9	35,2	47,1	43,2	30,7	45,0	46,5	52,9
ADK-1612MMS	003 619	32,3	29,6	21,1	30,8	31,9	36,3	48,5	44,4	31,6	46,3	47,9	54,5
ADK-164S	003 618	36,0	33,0	23,5	34,3	35,5	40,4	49,9	45,7	32,6	47,6	49,3	56,1
ADK-165	003 620	44,8	41,1	29,2	42,8	44,3	50,3	66,5	60,9	43,4	63,5	65,7	74,7
ADK-165S	003 621	49,7	45,6	32,4	47,4	49,1	55,8	72,4	66,3	47,2	69,1	71,5	81,3
ADK-303	003 622	17,7	16,2	11,5	16,9	17,5	19,9	25,4	23,2	16,5	24,2	25,0	28,5
ADK-304	003 623	31,3	28,7	20,4	29,9	30,9	35,2	47,1	43,2	30,7	45,0	46,5	52,9
ADK-304S	003 624	36,0	33,0	23,5	34,4	35,6	40,5	51,6	47,2	33,6	49,2	50,9	57,9
ADK-305	003 626	52,6	48,2	34,3	50,2	52,0	59,1	72,1	66,0	47,0	68,7	71,1	80,9
ADK-305S	003 627	52,8	48,4	34,4	50,4	52,1	59,3	72,9	66,8	47,6	69,6	72,0	81,9
ADK-307S	003 628	66,3	60,7	43,2	63,2	65,4	74,4	104,6	95,8	68,2	99,8	103,2	117,4
ADK-414	003 629	36,8	33,7	24,0	35,1	36,3	41,3	55,2	50,6	36,0	52,7	54,5	62,0
ADK-415	003 632	58,6	53,7	38,2	55,9	57,8	65,8	87,9	80,5	57,3	83,9	86,8	98,7
ADK-415S	003 633	63,0	57,7	41,1	60,1	62,2	70,7	94,5	86,6	61,6	90,2	93,3	106,1
ADK-417S	003 634	77,9	71,4	50,8	74,3	76,9	87,5	116,9	107,1	76,2	111,5	115,4	131,2
ADK-757S	003 635	105,5	96,7	68,8	100,7	104,2	118,5	158,3	145,0	103,2	151,0	156,2	177,7
ADK-759S	003 636	117,2	107,4	76,4	111,8	115,7	131,6	175,8	161,0	114,6	167,7	173,5	197,4

Nominal Operating Conditions

Nominal capacity (Qn) is based on the following conditions:

Refrigerant	Evaporating temperature	Liquid temperature
R 744	-10°C	+9°C
R 22, R 134a, R 404A, R 407C, R 410A, R 507	-15°C	+30°C

Correction factors for other than the nominal conditions see page 129/130.

Connections

Type	Part No.	Connection			
		Solder/ODF		Flare/SAE	
		mm	inch	mm	inch
ADK-032	003 595			6	1/4
ADK-036MMS	003 597	6			
ADK-032S	003 596		1/4		
ADK-052	003 598			6	1/4
ADK-056MMS	003 600	6			
ADK-052S	003 599		1/4		
ADK-053	003 601			10	3/8
ADK-0510MMS	003 603	10			
ADK-053S	003 602		3/8		
ADK-082	003 604			6	1/4
ADK-086MMS	003 606	6			
ADK-082S	003 605		1/4		
ADK-083	003 607			10	3/8
ADK-0810MMS	003 609	10			
ADK-083S	003 608		3/8		
ADK-084	003 610			12	1/2
ADK-0812MMS	003 612	12			
ADK-084S	003 611		1/2		
ADK-162	003 613			6	1/4
ADK-163	003 614			10	3/8

Type	Part No.	Connection			
		Solder/ODF		Flare/SAE	
		mm	inch	mm	inch
ADK-1610MMS	003 616	10			
ADK-163S	003 615		3/8		
ADK-164	003 617			12	1/2
ADK-1612MMS	003 619	12			
ADK-164S	003 618		1/2		
ADK-165	003 620			16	5/8
ADK-165S	003 621		5/8		
ADK-303	003 622			10	3/8
ADK-304	003 623			12	1/2
ADK-304S	003 624		1/2		
ADK-305	003 626			16	5/8
ADK-305S	003 627		5/8		
ADK-307S	003 628	22	7/8		
ADK-414	003 629			12	1/2
ADK-415	003 632			16	5/8
ADK-415S	003 633		5/8		
ADK-417S	003 634	22	7/8		
ADK-757S	003 635	22	7/8		
ADK-759S	003 636		1-1/8		

Water and Acid Capacity

Size	Water adsorption capacity (gram)										Acid Adsorption Capacity (gram)
	Liquid Temperature 24°C					Liquid Temperature 52°C					
	R 134a	R 22	R 404A/R 507	R 407C	R 410A	R 134a	R 22	R 404A/R 507	R 407C	R 410A	
ADK-03	4.9	4.5	4.9	3.4	2.8	4.4	4.0	4.6	2.9	2.4	0.8
ADK-05	11.8	10.8	11.8	8.2	6.8	10.6	9.6	10.9	7.0	5.8	2.3
ADK-08	17.9	16.4	18.0	12.4	10.3	16.2	14.6	16.6	10.7	8.8	3.3
ADK-16	23.0	21.0	23.1	16.0	13.2	20.8	18.8	21.3	13.8	11.4	4.5
ADK-30	51.8	48.6	53.5	36.9	30.6	47.4	43.3	49.3	31.8	26.3	11.3
ADK-41	81.7	76.6	84.3	58.2	48.3	74.8	68.3	77.8	50.2	41.4	16.8
ADK-75	143.5	134.5	148.1	102.1	84.8	131.4	120.0	136.6	88.1	72.8	29.9

Filter Driers Series FDB

Hermetic design, bead style, for liquid refrigerants

Features

- Compacted bead style (spring loaded)
- Optimum blend of molecular sieve and activated alumina combined with high filtration capacity
- Final filtration 20 micron
- Filtration first for more effective use of surface area of desiccant
- High water and acid capacity
- Cushioned flow for non-turbulent performance
- ODF Copper fittings for easy soldering
- Rugged steel shells
- Corrosion resistant epoxy paint
- Temperature range TS: -40°C to +65°C
- Max. working pressure PS: 43 bar
- No CE marking according art. 3.3 PED 97/23 EC
- HP marking according to German Pressurized Vessel Directive
- Underwriter Laboratories



FDB

Type	Part No.	Nominal Flow Capacity (kW)									
		at 0.07 bar pressure drop					at 0.14 bar pressure drop				
		R 134a	R 22	R 407C	R 404A / R 507	R 410A	R 134a	R 22	R 407C	R 404A / R 507	R 410A
FDB-032	059 305	6,3	6,9	6,6	4,5	6,8	8,9	9,7	9,3	6,3	9,6
FDB-032S	059 306	9,7	10,6	10,1	6,9	10,5	13,7	15,0	14,3	9,8	14,8
FDB-052	059 307	6,5	7,1	6,8	4,6	7,0	9,3	10,2	9,7	6,7	10,1
FDB-052S	059 309	9,7	10,6	10,1	6,9	10,5	13,7	15,0	14,3	9,8	14,8
FDB-053	059 308	15,5	16,9	16,1	11,0	16,7	22,2	24,2	23,1	15,8	23,9
FDB-053S	059 310	19,3	21,1	20,1	13,8	20,8	27,6	30,1	28,7	19,6	29,7
FDB-082	059 311	6,8	7,4	7,1	4,8	7,3	9,8	10,7	10,2	7,0	10,6
FDB-082S	059 314	9,9	10,8	10,3	7,0	10,7	14,2	15,5	14,8	10,1	15,3
FDB-083	059 312	15,8	17,2	16,4	11,2	17,0	22,6	24,7	23,6	16,1	24,4
FDB-083S	059 315	19,8	21,6	20,6	14,1	21,3	28,4	31,0	29,6	20,2	30,6
FDB-084	059 313	26,4	28,8	27,5	18,8	28,4	37,7	41,2	39,3	26,9	40,7
FDB-084S	059 316	28,3	30,9	29,5	20,1	30,5	40,4	44,1	42,1	28,8	43,5
FDB-162	059 317	6,8	7,4	7,1	4,8	7,3	9,8	10,7	10,2	7,0	10,6
FDB-163	059 318	16,2	17,7	16,9	11,5	17,5	23,1	25,2	24,0	16,4	24,9
FDB-163S	059 321	23,0	25,1	23,9	16,4	24,8	32,9	35,9	34,2	23,4	35,4
FDB-164	059 319	27,9	30,5	29,1	19,9	30,1	39,9	43,6	41,6	28,4	43,0
FDB-164S	059 322	36,0	39,3	37,5	25,6	38,8	51,5	56,2	53,6	36,6	55,5
FDB-165	059 320	36,6	40,0	38,2	26,1	39,5	52,4	57,2	54,6	37,3	56,5
FDB-165S	059 323	48,8	53,3	50,8	34,8	52,6	69,7	76,1	72,6	49,6	75,1
FDB-303	059 324	18,0	19,7	18,8	12,8	19,4	25,7	28,1	26,8	18,3	27,7
FDB-304	059 325	31,8	34,7	33,1	22,6	34,2	45,3	49,5	47,2	32,3	48,9
FDB-304S	003 667	38,0	41,5	39,6	27,1	41,0	54,2	59,2	56,5	38,6	58,4
FDB-305	059 326	40,3	44,0	42,0	28,7	43,4	57,7	63,0	60,1	41,1	62,2
FDB-305S	059 327	53,8	58,7	56,0	38,3	57,9	76,9	83,9	80,0	54,7	82,8
FDB-307S	059 328	60,5	66,1	63,1	43,1	65,2	86,6	94,5	90,2	61,6	93,3
FDB-415	059 329	49,7	54,3	51,8	35,4	53,6	71,1	77,6	74,0	50,6	76,6
FDB-417S	059 330	77,2	84,3	80,4	55,0	83,2	110,3	120,4	114,9	78,5	118,8

Connections

Type	Part No.	Connection	
		Solder/ODF or Flare/SAE inch	Solder/ODF or Flare/SAE mm
FDB-032	059 305	1/4" SAE	6mm SAE
FDB-032S	059 306	1/4" ODF	
FDB-052	059 307	1/4" SAE	6mm SAE
FDB-052S	059 309	1/4" ODF	
FDB-053	059 308	3/8" SAE	10mm SAE
FDB-053S	059 310	3/8" ODF	
FDB-082	059 311	1/4" SAE	6mm SAE
FDB-082S	059 314	1/4" ODF	
FDB-083	059 312	3/8" SAE	10mm SAE
FDB-083S	059 315	3/8" ODF	
FDB-084	059 313	1/2" SAE	12mm SAE
FDB-084S	059 316	1/2" ODF	
FDB-162	059 317	1/4" SAE	6mm SAE
FDB-163	059 318	3/8" SAE	10mm SAE

Type	Part No.	Connection	
		Solder/ODF or Flare/SAE inch	Solder/ODF or Flare/SAE mm
FDB-163S	059 321	3/8" ODF	
FDB-164	059 319	1/2" SAE	12mm SAE
FDB-164S	059 322	1/2" ODF	
FDB-165	059 320	5/8" SAE	16mm SAE
FDB-165S	059 323	5/8" ODF	
FDB-303	059 324	3/8" SAE	10mm SAE
FDB-304	059 325	1/2" SAE	12mm SAE
FDB-304S	003 667	1/2" ODF	
FDB-305	059 326	5/8" SAE	16mm SAE
FDB-305S	059 327	5/8" ODF	
FDB-307S	059 328	7/8" ODF	
FDB-415	059 329	5/8" SAE	16mm SAE
FDB-417S	059 330	7/8" ODF	

Water Adsorption Capacity

Type	Unit size	Water adsorption capacity (net) in grams							
		25°C liquid refrigerant				52°C liquid refrigerant			
		R 134a	R 22	R 407C	R 404A / R 507	R 134a	R 22	R 407C	R 404A / R 507
FDB-03...	3	1.9	2.0	1.7	1.9	1.8	1.7	1.6	1.9
FDB-05...	5	5.5	5.8	5.0	5.5	5.2	4.9	4.5	5.3
FDB-08...	8	8.8	9.3	8.0	8.8	8.4	7.9	7.2	8.5
FDB-16...	16	17.7	18.5	15.9	17.6	16.8	15.7	14.5	17.1
FDB-30...	30	31.7	33.0	28.5	31.6	30.1	28.2	26.0	30.5
FDB-41...	41	44.2	46.2	39.9	44.1	42.1	39.4	36.3	42.7

The water capacities are according to ARI-Standard 710 for R-22 and are based on an equilibrium point dryness (EPD) of 60 PPM water in refrigerant. ARI-standard does not refer to new alternative refrigerants.

The water capacities for new alternative refrigerants are based on the following equilibrium point dryness (EPD):

Refrigerant	EPD
R-134a	60 PPM
R-407C	60 PPM
R-404A	50 PPM
R-507	50 PPM

Filter Drier Shells Series ADKS-Plus

for Liquid- and Suction Applications with Replaceable Cores

Features of Shells

- Rustproof Aluminum flange cover with notch hole for ease of mounting
- Rigid core holder from steel (no plastic)
- Service friendly core holder and flange cover
- Optimum flow capacity at low pressure drop
- ODF Copper fittings for easy soldering
- Temperature range TS: -45°C to +65°C
- Max. working pressure PS:
34,5 bar (-10°C to +65°C)
25,9 bar (-45°C to -10°C)
- CE marking according PED 97/23 EC



ADKS-Plus



Core S48

Type ADKS-Plus	Part No.	Connection Solder/ODF mm inch		Nominal Flow Capacity (kW)										Number of Blocks S48, H48 W48, F48
				Pressure Drop 0,07 bar					Pressure Drop 0,14 bar					
				R 22	R 134a	R 507 R 404A	R 407C	R 410A	R 22	R 134a	R 507 R 404A	R 407C	R 410A	
Conformity assessment cat. I, procedure module D1 (applied higher module as required)														
485T	883 551	16	5/8"	78	72	51	75	77	100	92	65	95	99	1
487T	883 552	22	7/8"	145	133	95	138	143	182	167	119	174	180	
489T	883 553		1-1/8"	204	187	133	195	202	262	240	171	250	258	
4811T	883 554	35	1-3/8"	285	261	186	272	281	355	325	231	338	350	
4813T MM	883 836	42		310	284	202	296	306	390	357	254	372	385	
4817	882 603	54	2-1/8"	Primary for suction line applications										
967T	883 555	22	7/8"	159	146	104	152	157	199	182	129	189	196	2
969T	883 556		1-1/8"	250	229	163	239	247	300	275	196	286	296	
9611T	883 557	35	1-3/8"	305	279	199	291	301	402	369	262	384	397	
9613T	883 558		1-5/8"	350	321	228	334	345	470	431	306	448	464	
9613T MM	883 559	42		355	325	231	339	350	480	440	313	458	474	
9617	887 215	54		350	321	228	334	345	470	431	306	448	464	
1449T	883 560		1-1/8"	252	231	165	241	249	313	287	204	299	309	3
14411T	883 561	35	1-3/8"	351	322	229	335	347	438	401	285	417	432	
14413T	883 562		1-5/8"	354	325	231	338	350	482	441	314	460	476	
14413T MM	883 563	42		360	330	235	343	355	490	449	319	467	484	
14417T	883 564	54	2-1/8"	420	385	274	401	415	560	513	365	534	553	
Conformity assessment cat. II, procedure module D1														
19211T	883 565	35	1-3/8"	358	328	233	342	353	440	403	287	419	434	4
19213T	883 566		1-5/8"	395	362	258	377	390	506	464	330	483	500	
19213T MM	883 567	42		400	366	261	382	395	510	467	333	487	503	
19217T	883 568	54	2-1/8"	430	394	281	411	425	567	519	370	541	560	

Correction factors for other than the nominal conditions see page 129.

Cores for ADKS-Plus and FDH have to be ordered separately

Size	Part No.	Water Adsorption Capacity (gram)								Acid Adsorption capacity (g)
		Liquid Temperature 24°C				Liquid Temperature 52°C				
		R134a	R22	R404A / R507	R407C	R134a	R22	R404A / R507	R407C	
S48	003 508	79.7	74.7	82.3	56.7	73.0	66.7	75.9	48.9	16.3
H48	006 969	35.0	31.7	37.0	24.4	29.0	24.5	28.9	18.1	44.6
W48	006 970	24.7	22.1	26.2	17.1	19.9	16.4	19.5	12.1	39.7
F48	006 973	Filter for suction line								
H100 / W100 are for use with phased-out ADKS-300 / -400 only										
H100	006 971	59.9	53.3	63.8	41.2	47.4	38.3	46.0	28.5	105.1
W100	006 972	52.7	47.1	56.0	36.4	42.4	34.7	41.4	25.7	85.5

Filter Drier Shells Series FDH

for Liquid- and Suction Applications with Replaceable Cores

Features of Shells

- Steel flange cover with notch hole for ease of mounting
- Rigid core holder from steel (no plastic)
- Service friendly core holder and flange cover
- Optimum flow capacity at low pressure drop
- Steel plated ODF connections
- Temperature range TS: -45°C to +65°C
- Max. working pressure PS:
46 bar (-10°C to +65°C)
25,9 bar (-45°C to -11°C)
- CE marking according PED 97/23 EC



FDH

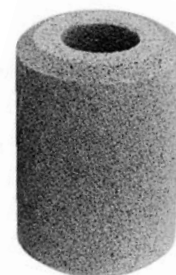

Core H48

Type FDH-	Part No.	Connection Solder/ODF mm inch		Nominal Flow Capacity (kW)						Number of Blocks S48, H48 W48, F48
				Pressure Drop 0,07 bar						
				R 744	R 410A	R 507 R 404A	R 407C	R 410A	R 134a	
Conformity assessment cat. I, procedure module D1 (applied higher module as required)										
485	880 300	16	5/8"	114	77	51	75	72	78	1
487	880 301	22	7/8"	211	143	95	138	133	145	
489	880 302		1-1/8"	297	202	133	195	187	204	
969	880 306		1-1/8"	364	247	163	239	229	250	2
9611	880 307	35	1-3/8"	443	301	199	291	279	305	

Correction factors for other than the nominal conditions see page 129.

Filter-Drier Shells With Quick-Cap Series FDS-24

for Liquid- and Suction Applications with Replaceable Cores

Features

- Quick-cap flange (one bolt) design makes replacing of cores in a matter of seconds
- Ideal for retrofit, reducing installation / material cost
- Ideal for refrigerant recovery / reclaim units with regular change of filter-drier
- Compatible with CFC, HCFC and HFC refrigerants
- Free volume as a receiver in FDS-24... (580 cm³)
- ODF Copper fittings for easy soldering
- Corrosion resistant powder painting of shell body
- Temperature range TS: -45°C to +65°C
- Max. working pressure PS:
 - 34,5 bar (-10°C to +65°C)
 - 25,9 bar (-45°C to -10°C)
- No CE marking according art.3.3 PED 97/23 EC
- HP marking according to German Pressurized Vessel Directive



FDS-24

Selection Chart Suction Application

Type	Part No.	Connection		Nominal Flow Capacity (kW)							
				Block Core S24				Filter F24			
				R 134a	R 22	R 407C	R 507/ R 404A	R 134a	R 22	R 407C	R 507/ R 404A
FDS-245	003 573	16	5/8	22.3	30.6	28.5	26.0	24.7	33.9	31.5	28.8
FDS-247	003 574	22	7/8	32.2	44.1	41.0	37.5	37.8	51.8	48.2	44.0
FDS-249	003 575		1-1/8	46.0	63.0	58.6	53.6	50.7	69.4	64.5	59.0
FDS-249	003 576	28		44.2	60.5	56.3	51.4	48.6	66.6	61.9	56.6

Selection Chart Liquid Application

Type	Part No.	Connection Solder/ODF		Nominal Flow Capacity (kW)									
				Pressure Drop 0.07 bar					Pressure Drop 0.14 bar				
				R 22	R 134a	R 507/ R 404A	R 407C	R 410A	R 22	R 134a	R 507/ R 404A	R 407C	R 410A
FDS-245	003 573	16	5/8"	75	68	49	71	74	98	90	64	93	97
FDS-247	003 574	22	7/8"	112	102	73	107	110	151	139	99	144	149
FDS-249	003 575		1-1/8"	113	104	74	108	112	160	147	104	153	158
FDS-249	003 576	28		114	104	74	108	112	163	150	106	156	161

Correction factors for other than the nominal conditions see page 129.

Selection Chart Cores

Type	Part No.	Water Capacity in Grams			Application	Acid Adsorption capacity (g)
		at a Liquid Temperature of 24°C (52°C)				
		R 134a	R 22	R 404A / R 507		
S24	003 504	35.2 (32.3)	34.8 (29.5)	35.4 (32.1)	Liquid and suction line	8.9
W24	003 505	12.5 (9.2)	12.3 (8.9)	13.5 (10.4)	For motor burn-out (Suction)	25.6
F24	003 506	- (-)	- (-)	- (-)	Filter for suction line	-

Cores have to be ordered separately. 1 piece needed for FDS24 shell.

Spare Parts

Description	Type	Part No.
ADKS-Plus, FDS		
Gasket Set	X 99961	003 710
Screw Set	X 99997	803 325
Schrader Nipple 1/4" NPT	X 11562-2	803 251
Core Holder	X 99963	003 712

Description	Type	Part No.
FDS 24		
Gasket Set	X 99967	003 716
O-Ring Set	X 99968	003 717
Core Holder	X 99969	003 718
Shell Holder	X 99970	003 719

Filter-Drier Shells With Quick-Cap Series FDS-48

for Liquid Applications with Replaceable Cores

Features

- Quick-cap flange (one bolt) design makes replacing of cores in a matter of seconds
- Ideal for retrofit, reducing installation / material cost
- Ideal for refrigerant recovery / reclaim units with regular change of filter-drier
- Rigid core holder from steel (no plastic)
- Service friendly core holder and flange cover
- Optimum flow capacity at low pressure drop
- ODF Copper fittings for easy soldering
- Temperature range TS: -45°C to +65°C
- Max. working pressure PS:
 - 34,5 bar (-10°C to +65°C)
 - 25,9 bar (-45°C to -10°C)
- marking according PED 97/23 EC



FDS-48

Selection Chart

Type	Part No.	Connection Solder/ODF mm ₁ inch	Nominal Flow Capacity (kW)										Number of Cores S48, H48 W48, F48	
			Pressure Drop 0.07bar					Pressure Drop 0.14bar						
			R 22	R 134a	R 507/ R 404A	R 407C	R 410A	R 22	R 134a	R 507/ R 404A	R 407C	R 410A		
Conformity assessment cat. I, procedure module D1 (applied higher module as required)													1	
FDS 485	883 577	16	5/8"	78	72	51	75	77	100	92	65	95		99
FDS 487	883 578	22	7/8"	145	133	95	138	143	182	167	119	174		180
FDS 489	883 579		1-1/8"	204	187	133	195	202	262	240	171	250		258
FDS 4811	883 580	35	1-3/8"	285	261	186	272	281	355	325	231	338		350

Correction factors for other than the nominal conditions see page 129.

Selection Chart Cores

Type	Part No.	Water adsorption capacity (gram)								Acid Adsorption Capacity (gram)
		Liquid Temperature 24°C				Liquid Temperature 52°C				
		R 134a	R 22	R 404A / R 507	R 407C	R 134a	R 22	R 404A / R 507	R 407C	
S48	003 508	79.7	74.7	82.3	56.7	73.0	66.7	75.9	48.9	16.3
H48	006 969	35.0	31.7	37.0	24.4	29.0	24.5	28.9	18.1	44.6
W48	006 970	24.7	22.1	26.2	17.1	19.9	16.4	19.5	12.1	39.7
F48	006 973	Filter for suction line								

Cores have to be ordered separately

Spare Parts

Description	Type	Part No.
Gasket Set	X 99961	003 710
O-Ring Set	X 99962	003 711
Shell Holder	X 99965	003 714
Screw Set	X 99997	803 325
Schrader Nipple 1/4" NPT	X 11562-2	803 251
Core Holder	X 99963	003 712



Correction Tables for Filter Driers ADK, BFK, FDB, FDS and ADKS

Filter drier selection for operating conditions other than -15°C/+30°C:

$$Q_n = Q_0 \times K_t$$

- Q_n : Nominal flow capacity
- Q_0 : Required cooling capacity
- K_t : Correction factor for evaporating and liquid temperature

Refrigerant	Liquid temperature °C	Correction factor K_t													
		Evaporating temperature °C													
		20	15	10	5	0	-5	-10	-15	-20	-25	-30	-35	-40	-45
R 134a	60	1,29	1,32	1,35	1,39	1,42	1,46	1,50	1,55	1,59	1,65	1,70			
	55	1,20	1,22	1,25	1,28	1,31	1,34	1,38	1,41	1,45	1,50	1,54			
	50	1,11	1,14	1,16	1,19	1,21	1,24	1,27	1,30	1,34	1,38	1,42			
	45	1,04	1,06	1,09	1,11	1,13	1,16	1,18	1,21	1,24	1,27	1,31			
	40	0,98	1,00	1,02	1,04	1,06	1,08	1,11	1,13	1,16	1,19	1,22			
	35	0,93	0,94	0,96	0,98	1,00	1,02	1,04	1,06	1,08	1,11	1,14			
	30	0,88	0,90	0,91	0,93	0,94	0,96	0,98	1,00	1,02	1,04	1,07			
	25	0,84	0,85	0,86	0,88	0,89	0,91	0,93	0,95	0,96	0,98	1,01			
	20		0,81	0,82	0,84	0,85	0,87	0,88	0,90	0,92	0,93	0,95			
	15			0,79	0,80	0,81	0,83	0,84	0,85	0,87	0,89	0,90			
	10				0,76	0,78	0,79	0,80	0,82	0,83	0,84	0,86			
	5					0,74	0,76	0,77	0,78	0,79	0,81	0,82			
	0						0,73	0,74	0,75	0,76	0,77	0,79			
	-5							0,71	0,72	0,73	0,74	0,75			
-10								0,69	0,70	0,71	0,72				
R 404A	60	1,77	1,83	1,90	1,97	2,06	2,16	2,27	2,39	2,54	2,70	2,89	3,12	3,39	3,70
	55	1,48	1,52	1,56	1,62	1,67	1,74	1,81	1,90	1,99	2,09	2,21	2,34	2,50	2,67
	50	1,28	1,31	1,34	1,38	1,43	1,47	1,53	1,59	1,65	1,73	1,81	1,90	2,00	2,11
	45	1,13	1,16	1,18	1,21	1,25	1,29	1,33	1,38	1,43	1,48	1,54	1,61	1,68	1,76
	40	1,02	1,04	1,06	1,09	1,12	1,15	1,18	1,22	1,26	1,30	1,35	1,40	1,46	1,52
	35	0,93	0,95	0,97	0,99	1,01	1,04	1,07	1,10	1,13	1,17	1,20	1,25	1,29	1,34
	30	0,86	0,87	0,89	0,91	0,93	0,95	0,97	1,00	1,03	1,06	1,09	1,12	1,16	1,20
	25	0,80	0,81	0,83	0,84	0,86	0,88	0,90	0,92	0,94	0,97	1,00	1,03	1,06	1,09
	20		0,76	0,77	0,79	0,80	0,82	0,84	0,85	0,87	0,90	0,92	0,95	0,97	1,00
	15			0,72	0,74	0,75	0,77	0,78	0,80	0,82	0,84	0,86	0,88	0,90	0,93
	10				0,69	0,71	0,72	0,73	0,75	0,77	0,78	0,80	0,82	0,84	0,86
	5					0,67	0,68	0,69	0,71	0,72	0,74	0,75	0,77	0,79	0,81
	0						0,65	0,66	0,67	0,68	0,70	0,71	0,73	0,74	0,76
	-5							0,63	0,64	0,65	0,66	0,67	0,69	0,70	0,72
	-10								0,61	0,62	0,63	0,64	0,65	0,67	0,68
	-15									0,59	0,60	0,61	0,62	0,64	0,65
-20										0,56	0,57	0,58	0,59	0,61	
R 507	60	1,68	1,73	1,78	1,84	1,91	1,99	2,07	2,17	2,27	2,39	2,53	2,69	2,87	3,08
	55	1,43	1,46	1,50	1,54	1,59	1,65	1,71	1,77	1,85	1,93	2,02	2,12	2,24	2,36
	50	1,25	1,28	1,31	1,34	1,38	1,42	1,47	1,52	1,57	1,63	1,70	1,77	1,85	1,94
	45	1,12	1,14	1,17	1,20	1,23	1,26	1,30	1,34	1,38	1,42	1,48	1,53	1,59	1,66
	40	1,02	1,04	1,06	1,08	1,11	1,13	1,16	1,20	1,23	1,27	1,31	1,36	1,40	1,46
	35	0,94	0,95	0,97	0,99	1,01	1,04	1,06	1,09	1,12	1,15	1,18	1,22	1,26	1,30
	30	0,87	0,88	0,90	0,92	0,94	0,96	0,98	1,00	1,02	1,05	1,08	1,11	1,14	1,18
	25	0,81	0,83	0,84	0,85	0,87	0,89	0,91	0,93	0,95	0,97	1,00	1,02	1,05	1,08
	20		0,77	0,79	0,80	0,81	0,83	0,85	0,86	0,88	0,90	0,92	0,95	0,97	1,00
	15			0,74	0,75	0,77	0,78	0,79	0,81	0,83	0,84	0,86	0,88	0,91	0,93
	10				0,71	0,72	0,74	0,75	0,76	0,78	0,79	0,81	0,83	0,85	0,87
	5					0,68	0,70	0,71	0,72	0,73	0,75	0,76	0,78	0,80	0,81
	0						0,66	0,67	0,68	0,70	0,71	0,72	0,74	0,75	0,77
	-5							0,64	0,65	0,66	0,67	0,68	0,70	0,71	0,73
	-10								0,62	0,63	0,64	0,65	0,66	0,68	0,69
	-15									0,60	0,61	0,62	0,63	0,64	0,65
-20										0,58	0,59	0,60	0,61	0,62	

Refrigerant	Liquid temperature °C	Correction factor K_t													
		Evaporating temperature °C													
		20	15	10	5	0	-5	-10	-15	-20	-25	-30	-35	-40	-45
R 22	60	1,28	1,29	1,30	1,32	1,34	1,36	1,38	1,40	1,42	1,45	1,48	1,51	1,54	1,57
	55	1,20	1,21	1,23	1,24	1,26	1,27	1,29	1,31	1,33	1,35	1,38	1,41	1,43	1,46
	50	1,13	1,14	1,16	1,17	1,18	1,20	1,22	1,23	1,25	1,27	1,29	1,32	1,34	1,37
	45	1,07	1,08	1,09	1,11	1,12	1,13	1,15	1,16	1,18	1,20	1,22	1,24	1,26	1,29
	40	1,02	1,03	1,04	1,05	1,06	1,08	1,09	1,10	1,12	1,14	1,15	1,17	1,19	1,21
	35	0,97	0,98	0,99	1,00	1,01	1,02	1,04	1,05	1,06	1,08	1,09	1,11	1,13	1,15
	30	0,93	0,94	0,95	0,96	0,97	0,98	0,99	1,00	1,01	1,03	1,04	1,06	1,07	1,09
	25	0,89	0,90	0,91	0,91	0,92	0,93	0,94	0,95	0,97	0,98	0,99	1,01	1,02	1,04
	20		0,86	0,87	0,88	0,88	0,89	0,90	0,91	0,93	0,94	0,95	0,96	0,98	0,99
	15			0,83	0,84	0,85	0,86	0,87	0,88	0,89	0,90	0,91	0,92	0,93	0,95
	10				0,81	0,82	0,82	0,83	0,84	0,85	0,86	0,87	0,88	0,89	0,91
	5					0,79	0,79	0,80	0,81	0,82	0,83	0,84	0,85	0,86	0,87
	0						0,76	0,77	0,78	0,79	0,80	0,81	0,82	0,83	0,84
	-5							0,74	0,75	0,76	0,77	0,78	0,79	0,80	0,81
	-10								0,73	0,73	0,74	0,75	0,76	0,77	0,78
	-15									0,71	0,72	0,72	0,73	0,74	0,75
-20										0,69	0,70	0,71	0,72	0,72	
R 407C	60	1,40	1,42	1,45	1,49	1,52	1,56	1,61	1,65	1,70	1,76	1,82			
	55	1,27	1,29	1,32	1,35	1,38	1,41	1,44	1,48	1,52	1,57	1,61			
	50	1,17	1,19	1,21	1,23	1,26	1,28	1,31	1,35	1,38	1,42	1,46			
	45	1,08	1,10	1,12	1,14	1,16	1,18	1,21	1,24	1,26	1,30	1,33			
	40	1,01	1,02	1,04	1,06	1,08	1,10	1,12	1,14	1,17	1,20	1,22			
	35	0,95	0,96	0,98	0,99	1,01	1,03	1,05	1,07	1,09	1,11	1,14			
	30	0,89	0,91	0,92	0,93	0,95	0,96	0,98	1,00	1,02	1,04	1,06			
	25	0,85	0,86	0,87	0,88	0,90	0,91	0,93	0,94	0,96	0,98	1,00			
	20		0,81	0,82	0,84	0,85	0,86	0,88	0,89	0,91	0,92	0,94			
	15			0,79	0,80	0,81	0,82	0,83	0,85	0,86	0,88	0,89			
	10				0,76	0,77	0,78	0,79	0,81	0,82	0,83	0,85			
	5					0,74	0,75	0,76	0,77	0,78	0,79	0,81			
	0						0,72	0,73	0,74	0,75	0,76	0,77			
	-5							0,70	0,71	0,72	0,73	0,74			
	-10								0,68	0,69	0,70	0,71			
	R 410A*	60	1,62	1,64	1,66	1,68	1,70	1,73	1,76	1,80	1,83	1,87	1,92	1,96	2,02
55		1,42	1,43	1,44	1,46	1,48	1,50	1,53	1,55	1,58	1,61	1,64	1,68	1,72	1,76
50		1,27	1,28	1,29	1,31	1,32	1,34	1,36	1,38	1,40	1,43	1,45	1,48	1,51	1,55
45		1,16	1,17	1,18	1,19	1,20	1,22	1,24	1,25	1,27	1,29	1,31	1,34	1,36	1,39
40		1,07	1,08	1,09	1,10	1,11	1,12	1,14	1,15	1,17	1,18	1,20	1,22	1,24	1,27
35		1,00	1,01	1,01	1,02	1,03	1,04	1,06	1,07	1,08	1,10	1,11	1,13	1,15	1,17
30		0,94	0,94	0,95	0,96	0,97	0,98	0,99	1,00	1,01	1,03	1,04	1,06	1,07	1,09
25		0,89	0,89	0,90	0,90	0,91	0,92	0,93	0,94	0,95	0,96	0,98	0,99	1,00	1,02
20			0,84	0,85	0,86	0,86	0,87	0,88	0,89	0,90	0,91	0,92	0,93	0,95	0,96
15				0,81	0,81	0,82	0,83	0,84	0,84	0,85	0,86	0,87	0,88	0,90	0,91
10					0,78	0,78	0,79	0,80	0,80	0,81	0,82	0,83	0,84	0,85	0,86
5						0,75	0,75	0,76	0,77	0,77	0,78	0,79	0,80	0,81	0,82
0							0,72	0,73	0,73	0,74	0,75	0,76	0,76	0,77	0,78
-5								0,70	0,70	0,71	0,72	0,72	0,73	0,74	0,75
-10									0,68	0,68	0,69	0,69	0,70	0,71	0,72
R 744*				5	0	-5	-10	-15	-20	-25	-30	-35	-40	-45	-50
	9		1,04	1,02	1,01	1,00	1,00	0,99	0,99	0,99	1,00	1,00	1,01	1,01	
	5			0,96	0,94	0,94	0,93	0,93	0,93	0,93	0,93	0,94	0,94	0,95	
	0				0,88	0,87	0,87	0,87	0,87	0,87	0,87	0,87	0,88	0,88	
	-5					0,82	0,82	0,81	0,81	0,81	0,82	0,82	0,82	0,83	
	-10						0,77	0,77	0,77	0,77	0,77	0,77	0,78	0,78	
	-15							0,73	0,73	0,73	0,73	0,73	0,73	0,74	
	-20								0,69	0,69	0,69	0,70	0,70	0,70	
	-25									0,66	0,66	0,66	0,67	0,67	
	-30										0,63	0,63	0,64	0,64	
	-35											0,61	0,61	0,61	
	-40												0,59	0,59	
	-45													0,57	

* Do not exceed max. working pressure PS: ADK/FDB/BFK: 43.0 bar; ADKS/FDS: -10°C ... +65°C: 34.5 bar; -45°C ... +10°C: 25.9 bar

Suction Line Filters and Filter Driers Series ASF and ASD

Hermetic design

Features

- Minimum pressure drop due to internal construction and compacted bead style
- Service friendly with 2 Schrader valves for pressure drop measurement
- ODF Copper fittings for easy soldering
- Filtration down to 10 micron
- Temperature range TS: -45°C to +50°C
- Max. operating pressure PS: 27,5 bar
- No CE marking according art. 3.3 PED 97/23 EC
- HP marking according to German Pressurized Vessel Directive



ASF, ASD

Suction Line Filters

Type	Part No.	Connection Solder/ODF		Nominal Capacity Q _n kW				
		mm	inch	R 134a	R 22	R 404A	R 407C	R 507
ASF-28 S3	008 965		3/8	6,0	8,4	7,7	7,8	7,7
ASF-28 S4	008 941		1/2	9,9	14,4	13,4	13,4	13,4
ASF-35 S5	008 915		5/8	15,9	23,2	21,4	21,6	21,4
ASF-45 S6	008 946		3/4	23,3	34,5	32,0	32,1	32,0
ASF-45 S7	008 904	22	7/8	32,5	42,5	34,5	39,5	34,5
ASF-50 S9	008 908		1-1/8	46,0	67,1	55,5	62,4	55,5
ASF-75 S11	008 919	35	1-3/8	60,2	85,4	70,7	79,4	70,7
ASF-75 S13	008 940		1-5/8	65,4	87,5	73,1	81,4	73,1

Suction Line Filter Driers

Type	Part No.	Connection Solder/ODF		Nominal Capacity Q _n kW				
		mm	inch	R 134a	R 22	R 404A	R 407C	R 507
ASD-28 S3	008 909		3/8	5,5	8,1	7,4	7,5	7,4
ASD-28 S4	008 910		1/2	9,1	13,4	12,7	12,5	12,7
ASD-35 S5	008 899		5/8	14,3	20,4	19,0	19,0	19,0
ASD-45 S6	008 925		3/4	19,1	24,6	22,5	22,9	22,5
ASD-45 S7	008 896	22	7/8	25,0	32,3	26,4	30,0	26,4
ASD-50 S9	008 881		1-1/8	35,3	46,4	38,3	43,2	38,3
ASD-75 S11	008 891	35	1-3/8	42,9	56,9	47,8	52,9	47,8
ASD-75 S13	008 953		1-5/8	45,2	60,8	51,0	56,5	51,0

Nominal flow capacity at +4°C evaporating temperature (saturated condition/dew point) and a pressure drop of 0.21 bar between inlet and outlet of ASF/ASD. Correction factor for other evaporating temperatures than +4°C:

Q_n: Nominal capacity
 K_s: Correction factor for a pressure drop corresponding 1 K saturation temperature
 Q_o: Required cooling capacity

$$Q_n = Q_o \times K_s$$

Evaporating Temperature (°C)	+4	0	-5	-10	-15	-20	-25	-30	-35	-40
Correction Factor K _s	1,00	1,12	1,35	1,75	2,00	2,50	3,00	3,75	5,00	6,60

Water and Acid Adsorption Capacity

Type	Water adsorption capacity (gram)										Acid Adsorption Capacity (g)
	Liquid Temperature 24°C					Liquid Temperature 52°C					
	R 134a	R 22	R 404A/R 507	R 407C	R 410A	R 134a	R 22	R 404A/R 507	R 407C	R 410A	
ASD-28	11.8	5.7	12.2	9.1	8.0	10.0	3.6	9.7	6.7	5.6	3.0
ASD-35	14.5	7.0	15.0	11.2	9.9	12.3	4.4	12.0	8.2	6.9	3.6
ASD-45	18.0	8.8	18.6	13.9	12.3	15.3	5.5	14.9	10.2	8.6	4.5
ASD-50	21.4	10.4	22.2	16.5	14.6	18.2	6.5	17.7	12.1	10.2	5.4
ASD-75	31.5	15.4	32.6	24.3	21.5	26.7	9.6	26.0	17.8	15.0	7.9

Suction Line Filter and Filter Drier Shells Series BTAS

for replaceable Filters and Filter Drier Cores

Features

- Corrosion resistant brass body ideal for suction line applications
- Extremely large filtration area for optimum flow capacity
- Low pressure drop
- Filtration down to 10 micron
- Temperature range TS: -45°C ... +50°C
- Max. working pressure PS: 24 bar



BTAS

Suction Line Shells With Filter Cores

Type	Part No.	Connection Solder/ODF		Nominal Capacity Q _n					Filter Core	
		mm	inch	R 134a	R 22	R 404A	R 407C	R 507	Type	Part No.
No CE marking according to art. 3.3 PED 97/23. HP marking according to German pressurised vessel directive										
BTAS 25	015 353		5/8	12,5	17,1	13,9	15,9	13,9	A2F	009 907
BTAS 27	015 354	22	7/8	22,3	29,6	24,3	27,5	24,3		
BTAS 39	015 355		1-1/8	37,7	50,4	40,6	46,9	40,6	A3F	009 909
BTAS 311	015 356	35	1-3/8	60,3	80,7	65,2	75,1	65,2		
BTAS 313	015 357		1-5/8	73,4	97,5	81,1	90,7	81,1		
BTAS 342	015 358	42		73,4	97,5	81,1	90,7	81,1		
BTAS 317	015 359	54	2-1/8	97,6	127,7	104,8	118,8	104,8	A4F	009 911
BTAS 417	015 360	54	2-1/8	134,7	178,2	145,3	165,7	145,3		
CE marked. Conformity assessment cat. I, procedure module A.										
BTAS 521	015 361		2-5/8	209,0	282,4	229,8	262,6	229,8	A5F	009 913
BTAS 525	015 362		3-1/8	260,1	346,1	283,9	321,9	283,9		
BTAS-580	015 363	80		260,1	346,1	283,9	321,9	283,9		

Filter and Filter Drier Cores have to be ordered separately.

Suction Line Shells With Filter Drier Cores

Type	Part No.	Connection Solder/ODF		Nominal Capacity Q _n					Filter Drier Core	
		mm	inch	R 134a	R 22	R 404A	R 407C	R 507	Type	Part No.
No CE marking according to art. 3.3 PED 97/23. HP marking according to German pressurised vessel directive										
BTAS 25	015 353		5/8	11,6	15,5	12,8	14,4	12,8	A2F- D	009 908
BTAS 27	015 354	22	7/8	19,1	25,2	20,6	23,4	20,6		
BTAS 39	015 355		1-1/8	34,4	45,7	37,5	42,5	37,5	A3F- D	009 910
BTAS 311	015 356	35	1-3/8	49,2	65,5	53,7	60,9	53,7		
BTAS 313	015 357		1-5/8	57,1	77,3	62,5	71,9	62,5		
BTAS 342	015 358	42		57,1	77,3	62,5	71,9	62,5		
BTAS 317	015 359	54	2-1/8	71,1	94,1	77,7	87,5	77,7	A4F- D	009 912
BTAS 417	015 360	54	2-1/8	106,8	144,5	118,3	134,4	118,3		
CE marked. Conformity assessment cat. I, procedure module A										
BTAS-521	015 361		2-5/8	153,3	205,1	169,0	190,7	169,0	A5F- D	009 914
BTAS-525	015 362		3-1/8	181,2	242,0	199,4	225,1	199,4		
BTAS-580	015 363	80		181,2	242,0	199,4	225,1	199,4		

Filter and Filter Drier Cores have to be ordered separately.



Nominal capacity at +4°C evaporating temperature (saturated condition/dew point) and a pressure drop of 0.21 bar between inlet and outlet of BTAS. Correction factor for other evaporating temperatures than +4°C:

Q_n: Nominal capacity
 K_s: Correction factor for a pressure drop corresponding 1K saturation temperature
 Q_o: Required cooling capacity

$$Q_n = Q_o \times K_s$$

Evaporating Temperature (°C)	+4	0	-5	-10	-15	-20	-25	-30	-35	-40
Correction Factor K _s	1,00	1,12	1,35	1,75	2,00	2,50	3,00	3,75	5,00	6,60

BTAS - Water and Acid Adsorption Capacity

Core	Water adsorption capacity (grams)								Acid Adsorption (grams)
	Liquid Temperature 24°C				Liquid Temperature 52°C				
	R134a	R22	R404A / R 507	R407C	R134a	R22	R404A / R 507	R407C	
A2F-D	2.8	2.5	2.9	4.8	2.3	1.9	2.3	5.0	3.7
A3F-D	7.6	6.8	8.0	13.3	6.3	5.3	6.2	13.8	10.3
A4F-D	14.8	13.3	15.7	25.9	12.2	10.3	12.2	26.9	20.1
A5F-D	21.8	19.6	23.1	38.2	18.0	15.1	17.9	39.7	29.6

Spare Parts

Springs		
	Type	Part No.
Spring BTAS 2 (Package with 10 pieces)	KD 40009	064 790
Spring BTAS 3 (Package with 10 pieces)	KD 40010	064 813
Spring BTAS 4 (Package with 10 pieces)	KD 40011	064 814
Spring BTAS 5 (Package with 10 pieces)	KD 40007	064 443
Cover Plate Gaskets		
	Type	Part No.
Cover Plate Gasket BTAS 2	PS 23380-2	053 580
Cover Plate Gasket BTAS 3	PS 23380-3	053 581
Cover Plate Gasket BTAS 4	PS 23380-4	053 582
Cover Plate Gasket BTAS 5	PS 23380-5	053 583

Moisture Liquid Indicators Series MIA

Features

- Fully hermetic
- Corrosion free stainless steel body
- Crystal Indicator element for long lifetime and reliability
- Indication of dryness according to ASERCOM recommendation
- Easy determination of moisture content
- Sensitive indicator with calibrated four colours
- Large clear viewing area
- Lightweight (only 60g MIA-M06/014)
- ODF extended tube configurations suitable for all commercial applications
- For R22, R407C, R134a, R404A, R507 and R410A together with Mineral- and POE oils
- Max. operating pressure PS: 43 bar
- UL certified for Canada, see SA 4876 (except MIA-078)



MIA

Selection Chart

Type	Part No.	for Tube Outside Ø	Height A (mm)	Length B (mm)	Weight (g)
MIA 014	805 851	1/4"	25,5	98,0	60
MIA 038	805 852	3/8"	35,5	109,0	80
MIA 012	805 853	1/2"	35,5	113,0	90
MIA 058	805 854	5/8"	35,5	108,5	95
MIA 078	805 864	7/8"	35,5	122,5	170
MIA M06	805 846	6 mm	25,5	98,0	60
MIA M10	805 847	10 mm	35,5	109,0	80
MIA M12	805 848	12 mm	35,5	113,0	90
MIA M16	805 854	16 mm	35,5	108,5	95

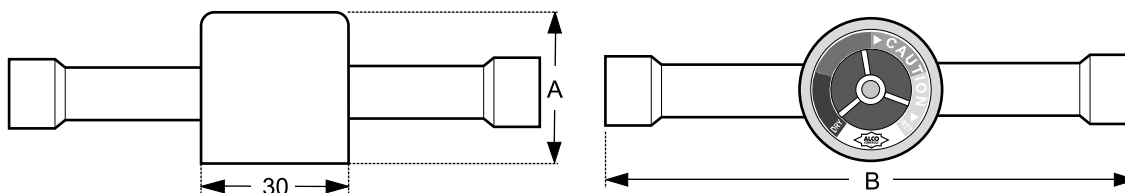

Water Contents* by Indicator Color

Refrigerant	Liquid Temperature °C	blue dry	purple	fuchsia Caution	rose Caution - wet
R 22	25	25	40	80	145
	38	35	65	130	205
	52	50	90	185	290
R 404A / R 507	25	15	33	60	120
	38	25	50	110	150
	52	45	60	140	180
R 134a	25	20	35	90	130
	38	35	55	120	160
	52	50	85	150	190
R 407C	25	26	42	94	151
	38	40	68	144	232
	52	64	109	230	371
R 410A	25	30	50	110	165
	38	55	85	190	290
	52	75	120	270	420

*Water content in mg Water per kg refrigerant (ppm)

Moisture Liquid Indicators Series AMI

Features

- First choice for R 134a, R 22, R 404A, R 507 and polyolester lubricants
- High accuracy of moisture indication according to ASERCOM recommendation
- Fused glass - no leakage
- Long lifetime of indicators by utilization of crystals
- Indicator with high resistance against acid and water
- Wide angle view for exact distinction of vapour and liquid
- Max. operating pressure PS: 31 bar



AMI-1 SS



AMI-1 TT



AMI-3

Selection Chart

Type	Part No.	Connection		Configuration	
		mm	inch		
AMI - 1	SS 2 MM	805 732	6	Female Solder x Female Solder ODF x ODF	
	SS 2	805 713	1/4		
	SS 3 MM	805 733	10		
	SS 3	805 714	3/8		
	SS 4 MM	805 734	12		
	SS 4	805 715	1/2		
	SS 5	805 716	16		5/8
	SS 7	805 717	22		7/8
	SS 9 MM	805 703	28		
	SS 9	805 705			1-1/8
	TT 2 MM	805 697	6	Female Solder x Female Solder ODF x ODF (with extended Copper tubes)	
	TT 2	805 655			1/4
	TT 3 MM	805 698	10		
	TT 3	805 654			3/8
	TT 4 MM	805 699	12		
	TT 4	805 653			1/2
	TT 5	805 652	16		5/8
	TT 7	805 656	22		7/8
	TT 9 MM	805 700	28		
	TT 9	805 651			1-1/8
AMI - 1	MM 2	805 706	6	Male Flare x Male Flare	
	MM 3	805 707	10		3/8
	MM 4	805 708	12		1/2
	MM 5	805 709	16		5/8
AMI - 1	FM 2	805 710	6	Female Flare x Male Flare	
	FM 3	805 711	10		3/8
	FM 4	805 712	12		1/2
AMI - 2	S 11	805 704	35	Male Solder ODM (for soldering into fittings)	
	S 13	805 659	42		1-5/8
	S 17	805 687	54		2-1/8
AMI - 3	S 7	805 650	22	Saddle Type (for soldering onto the pipe)	
	S 9	805 649	28		1-1/8
	S 11	805 648	35		1-3/8

Water Contents* by Indicator Color

Refrigerant	Liquid Temperature °C	blue dry	purple	fuchsia Caution	rose Caution - wet
R 22	25	25	40	80	145
	38	35	65	130	205
	52	50	90	185	290
R 404A / R 507	25	15	33	60	120
	38	25	50	110	150
	52	45	60	140	180
R 134a	25	20	35	90	130
	38	35	55	120	160
	52	50	85	150	190
R 407C	25	26	42	94	151
	38	40	68	144	232
	52	64	109	230	371

*Water content in mg Water per kg refrigerant (ppm)

Accessories

	Type	Part No.
Lens Assembly Kit	X 12978-1	805 742
O-Ring	X 99995	805 643



Oil Management Components

Oil Management Components

Technical Information

Refrigeration compressors are lubricated by refrigeration oil that circulates from the compressor crankcase or housing. As refrigerant gas is discharged by the compressor, it will leave with a fine oil mist, that will be circulated throughout the entire system.

Small amounts of oil circulating through the system will not affect the system performance. Too much refrigeration oil circulating in the system will have adverse effects on the components in the system. Circulating oil reduces the ability of the system to effectively remove the heat. Condensers, evaporators and other heat exchangers lose efficiency when coated internally with an oil film.

Refrigeration oil not returning to the compressor causes improper lubrication and eventual compressor failure. At low temperature application, refrigeration oil thickness becomes difficult to move, causing oil to be trapped in the system.

Oil separator function

Refrigerant gas leaving the compressor through the discharge line contains refrigeration oil in a vaporous mist. As this mixture enters the oil separator, the velocity is reduced to allow oil separation to begin.

The refrigerant gas and oil mixture enters the oil separator and passes through an inlet screen, causing the fine particles to combine. Larger oil particles are formed and drop to the bottom of the oil separator.

The refrigerant gas then passes through an outlet screen to remove residual oil particles. The oil gathers in the bottom of the oil separator until a float operated needle valve opens to allow the return of oil to the compressor. Oil returns quickly to the compressor, because of the higher pressure in the oil separator than in the compressor crankcase. When the oil level has lowered, the needle valve retracts to prevent refrigerant gas from returning back to the compressor. The refrigerant gas leaves through the outlet of the oil separator and goes to the condenser

Oil level management system function

This system provides oil level balancing as well as oil level monitoring including alarm and compressor shut-down functions. The oil level is measured inside the compressor's crankcase. By operating an integrated solenoid valve, missing oil can be fed from the oil receiver or from the oil separator directly into the compressor sump. If oil level drops to a dangerous level the alarm contact changes into alarm state. The alarm contact may be used to shut down the compressor. The integrated electronics includes delay times in order to avoid short-cycling and nuisance alarms.

This system applies to compressor pack applications with multiple parallel compressor arrangements but also to stand-alone compressor applications for compressors without differential oil pressure monitoring.

Electronic Oil Level Management Systems OM3 / OM4

with alarm function and compressor shut down

Features

- **OM4 for high pressure refrigerants**
- IP65 rating due to molded housing and electrical connection with molded cable assemblies
- 3 Zone 100% level control by using precise Hall-sensor measurement
- CE marking under Low Voltage and EMC Directive
- Self contained unit with oil level sensor and integral solenoid to manage oil level supply
- SPDT output contact for compressor shut down or alarming, rating 230 VAC/3A
- Power supply 24 VAC, 50/60 Hz
- Alarm, status and 3 zone indication by LED's
- Easy installation by sightglass replacement and frontside installation without nuts
- Visual inspection of oil level still possible



OM3 / OM4 TRAXOIL

- Adapters suitable for various types of compressors
- Signal generated by gravity based float - not prone to errors by foaming or light like optical sensors
- Recommended by leading compressor manufacturers
- **CE** marking under Low Voltage and EMC Directive

Selection Chart OM3

OM3-CUA 805 030	Oil system with flange adapter 3- / 4-hole
	Arctic Circle G2, G4, G6
	Bitzer 4VC, 4TC, 4PC, 4NC, 4J, 4H, 4G, 6J, 6H, 6G, 6F, 8GC, 8FC
	Bock HA, HG (except HG/HA-34/22, see -CBB), O-Series
	Copeland D2, D3, D4, D6, D9, 4CC, 6CC
	Dorin all KP, K sizes (except those mentioned under -CBB)
	Frascold Series A, B, D, F, S, V, Z
OM3-CBB 805 032	Oil system with screw adapter 1 1/8"-18 UNEF
	Bitzer 2KC, 2JC, 2HC, 2GC, 2FC, 2EC, 2DC, 2CC, 4FC, 4EC, 4DC, 4CC
	Bock HA12/22/34, HG12/22/34
	Dorin all H, K100CC/CS, K150CC/CS, K180CC/CS, K200CC, K230CS, K235CC, K240SB, K40CC, K50CS, K75CC/CS-
	L'Unite Hermetique TAH, TAG
Maneurop LT, MT, SM, SZ	
OM3-CCA 805 033	Oil system with screw adapter 3/4"-14 NPTF
	Bitzer ZL, ZM Copeland ZB (except ZB 220, ZB 440), ZF, ZS
OM3-CCB 805 034	Oil system with screw adapter 1 1/8"-12 UNF Copeland DK, DL
OM3-CCC 805 035	Oil system with flange adapter 3-hole
	Copeland D8D, D8S_ (except D8SJ and D8SK, installation only on one sight glass)
OM3-CCD 805 031	Oil system with Rotalockadapter 1-3/4"-12 UNF
	Copeland ZB220, ZR90 .. ZR19M, ZR250 .. ZR380, ZRT180K to 760K, ZRU280K-560K, ZRY480K-1140K
OM3-CCE 805 029	Oil system with Rotalockadapter 1-1/4"-12 UNF
	Copeland ZR 108/125/144, ZR 94/160/190
OM3-CCF 805 028	Oil system with flange adapter 4-hole Copeland ZB 440

Selection Chart OM4 for high pressure refrigerants

OM4-CUA 805 060	Oil system with flange adapter 3- / 4-hole
	Bitzer 4VHC-10K, 4THC-12K, 4PHC-15K, 4NHC-20K
	Dorin SCC 250/300/350/380/500/750/1500/1900/2000/2500/-B, SCS 340/351/362/373/385/3K8/-D
	Frascold Series A-SK, D-SK, Series F-SK, Q-SK, Series S-SK
OM4-CBB 805 062	Oil system with screw adapter 1 1/8"-18 UNEF
	Bitzer 2- KHC-05K/JHC-07K/HHC-2K/GHC-2K/FHC-3K/EHC-3K/DHC-3K/CHC-4K, 4- FHC-5K/EHC-6K/DHC-7K/CHC-9K
	Bock HGX4 /310-4/385-4/465-4, HGX12P/60-4/75-4, HGX22P/60-4/90-4/125-4, HGX34P/215-4/255-4
OM4-CCA 805 063	Oil system with screw adapter 3/4"-14 NPTF
	Copeland ZO34, ZO45, ZO58, ZO104
OM4-CCB 805 064	Oil system with screw adapter 1 1/8"-12 UNF
OM4-CCC 805 065	Oil system with flange adapter 3-hole
OM4-CCD 805 061	Oil system with Rotalockadapter 1-3/4"-12 UNF
	Copeland ZP 235/295/385
OM4-CCE 805 066	Oil system with Rotalockadapter 1-1/4"-12 UNF
	Copeland ZP 103/120/137, ZP 90/154/182

See also EXCEL based ALCO Selection Tool.
Cable assemblies and Accessories see next page.

Cable Assemblies for OM3 / OM4

OM3-P30	805 151	Power Supply Cable 3.0m
OM3-P60	805 152	Power Supply Cable 6.0m
OM3-N30	805 141	Relay Cable 3.0m
OM3-N60	805 142	Relay Cable 6.0m



Accessories

ECT-323	804 424	Transformer 230 VAC / 24 VAC, 25 VA (supply of 1 pcs. OM3/OM4)
ECT-623	804 421	Transformer 230 VAC / 24 VAC, 60 VA (supply of 3 pcs. OM3/OM4)
ODP-33A	800 366	Differential oil check valve 3.5 bar, inlet: $15/16$ -18 UNF female, outlet: $5/8$ -18 UNF male

Ordering Information (Example)

Standard system requires the following parts:

Type	Part No.	Description
OM3-CUA	805 030	Oil level system with flange adapter 3- / 4-hole
OM3-P30	805 151	Power Supply Cable 3.0m
OM3-N30	805 141	Relay Cable 3.0m
ECT-323	804 424	Transformer 230 VAC / 24 VAC, 25 VA
ODP-33A	800 366	Differential Oil Check Valve 3.5 bar



Technical Data

Supply voltage / current	24 V AC, 50/60 Hz / 0.7 A	Medium compatibility	HCFC, HFC, mineral, synthetic, and ester lubricants
Maximum working pressure PS	OM3: 31 bar, OM4: 43 bar	Orientation of base unit	horizontal
Solenoid valve MOPD	OM3: 21 bar, OM4: 24 bar	Level Control	40 to 60% of sightglass height
Medium temperature	-20 to 80°C	Protection class	IP 65 (IEC529/EN 60529)
Ambient temperature	-20 to 50°C	Solenoid Coil	ALCO ASC 24 VAC, 50/60 Hz: 8VA
Time delay filling	10 s	Weight	850 ... 930g (dep. on adapter)
Time delay alarm	20 s	Alarm contact	max. 3A, 230VAC, SPDT dry contact
Body material	Aluminum		
Screw material	stainless steel		

Application

Traditional low pressure oil level management system

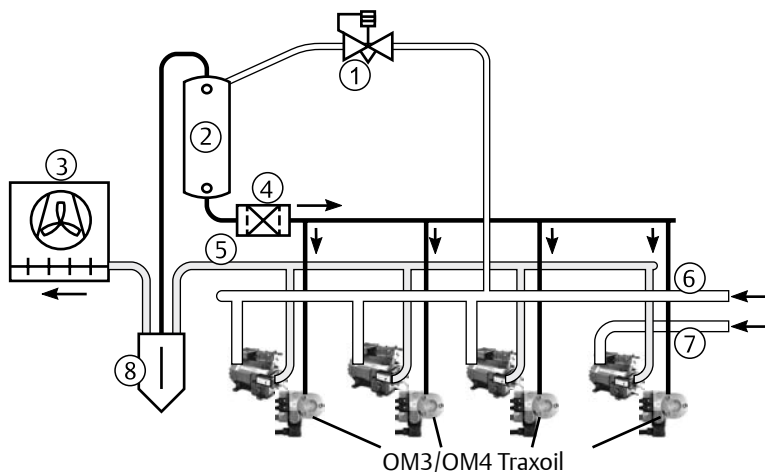

- 1: Differential pressure valve
- 2: Oil reservoir
- 3: Condenser
- 4: Filter Drier
- 5: Common Discharge
- 6: Common Suction Normal Temp
- 7: Suction Line Low Temp
- 8: Oil Separator

High pressure oil level management system

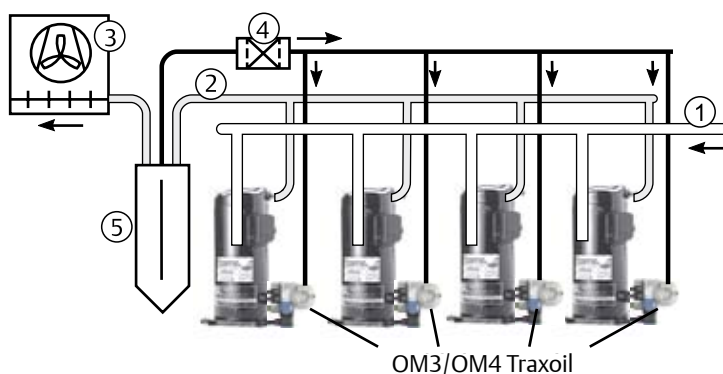

- 1: Common Suction
- 2: Common Discharge
- 3: Condenser
- 4: Filter Drier
- 5: Oil Separator

Oil Separator Series OS

Features

- Three different construction styles:
 - Hermetic
 - Top flange
 - Bottom flange with support bracket
- Stainless steel needle valve and floater
- Permanent magnet to catch iron particles out of the system
- Corrosion resistant epoxy powder painting
- ODF Copper fittings for easy soldering
- Temperature range TS: -40°C ... +65°C
- Max. working pressure PS: 31 bar (UL)
- CE marking according PED 97/23 EC



OSH



OST

Type Code

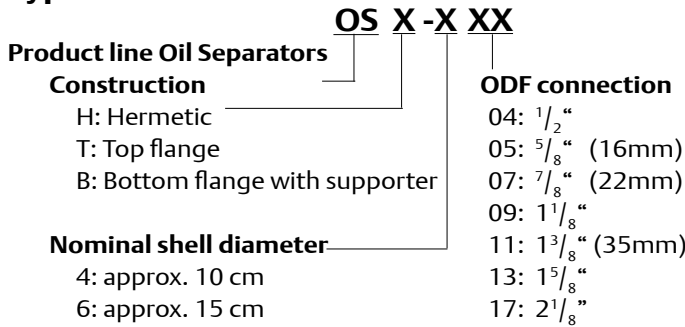

OSB

Type	Part No.	Connection	Conformity Assessment Category	Conformity Assessment Procedure	Nominal capacity (kW)			Volume Lit.
					R 22 / R 407C	R 134a	R 404A / R 507	
OSH-404	881 598	1/2"	Cat. I	Module D1*	7.0	4.9	7.3	2.0
OSH-405	881 599	5/8"			18.7	13.1	19.4	2.4
OSH-407	881 600	7/8"			28.1	19.7	29.0	2.8
OSH-409	881 792	1-1/8"			37.4	26.2	38.7	3.0
OSH-411	881 794	1-3/8"			46.8	32.8	48.4	3.6
OSH-413	881 856	1-5/8"			65.5	45.9	67.8	3.6
OSH-611	881 940	1-3/8"	Cat. II	Module D1	51.5	36.1	53.3	6.5
OSH-613	881 953	1-5/8"			65.5	45.9	67.8	7.9
OSH-642	889 022	42 mm			65.5	45.9	67.8	7.9
OSH-617	881 970	2-1/8"			105.3	73.8	108.9	7.9
OST-404	881 860	1/2"	Cat. I	Module D1*	7.0	4.9	7.3	1.8
OST-405	881 861	5/8"			18.7	13.1	19.4	2.6
OST-407	881 862	7/8"			28.1	19.7	29.0	3.2
OST-409	881 863	1-1/8"			37.4	26.2	38.7	3.8
OST-411	881 938	1-3/8"			46.8	32.8	48.4	3.8
OST-413	881 939	1-5/8"			65.5	45.9	67.8	3.8
OSB-613	881 971	1-5/8"	Cat. II	Module D1	65.5	45.9	67.8	7.8
OSB-617	881 972	2-1/8"			105.3	73.8	108.9	7.8

* applied higher module as required

Capacity Data for other than Nominal Operating Conditions

Nominal capacities at +38°C condensing temperature (+38°C bubble point or +43°C dew point for R407C), +4°C evaporating temperature (saturated temperatures / dew point) and 1 K liquid subcooling at the inlet of the expansion valve.

Correction factor for other evaporating temperatures than nominal:

$$Q_n = Q_o \times K_t$$

Q_n : Nominal capacity

K_t : Correction factor for a pressure drop corresponding 1 K saturation temperature

Q_o : Required cooling capacity

Correction Factors

Refrigerant	Condensing Temperature °C	Correction factor K_t						
		Evaporating temperature °C						
		10	0	-10	-20	-30	-40	-50
R 22 R 407	25	1,29	1,31	1,33	1,36	1,40	1,44	1,49
	30	1,16	1,17	1,20	1,23	1,27	1,31	1,36
	35	1,05	1,07	1,09	1,11	1,13	1,17	1,23
	40	0,95	0,96	0,98	1,00	1,03	1,07	1,12
	45	0,87	0,88	0,90	0,92	0,95	0,99	1,04
	50	0,81	0,83	0,85	0,87	0,89	0,93	0,99

Refrigerant	Condensing Temperature °C	Correction factor K_t					
		Evaporating temperature °C					
		10	0	-10	-20	-30	
R 134a	25	1,31	1,36	1,39	1,43	1,50	
	30	1,18	1,21	1,24	1,28	1,35	
	35	1,06	1,08	1,11	1,15	1,21	
	40	0,95	0,98	1,01	1,05	1,10	
	45	0,86	0,88	0,92	0,95	1,02	
	50	0,80	0,81	0,85	0,89	0,97	

Refrigerant	Condensing Temperature °C	Correction factor K_t						
		Evaporating temperature °C						
		10	0	-10	-20	-30	-40	-50
R 404A R 507	25	1,22	1,25	1,30	1,33	1,43	1,53	1,63
	30	1,12	1,15	1,20	1,26	1,32	1,42	1,54
	35	1,03	1,06	1,11	1,16	1,24	1,34	1,46
	40	0,95	0,99	1,04	1,09	1,17	1,28	1,41
	45	0,90	0,92	0,97	1,03	1,14	1,26	1,39
	50	0,86	0,89	0,93	1,00	1,13	1,26	1,39



Ball Valves, Miscellaneous

Suction Accumulators Series A

Features

- Hermetic design
- ODF Copper fittings for easy soldering
- Corrosion resistant epoxy powder painting
- Internal orifice with strainer for optimum oil return
- Temperature range TS: -45°C to +65°C
- Max. working pressure PS:
20.7 bar (-10°C to +65°C)
15.5 bar (-45°C to -10°C)
- CE marking for certain types according PED 97/23 EC
- HP marking for certain types according German pressurised vessels directive



A08

Type	Part No.	Connection	Nominal Capacity Q _n (kW)						Conformity Assessment		Volume Lit.	
			R 22 / R407C		R 134a		R 404A / R 507		Category	Procedure		
			Max.	Min.	Max.	Min.	Max.	Min.				
A08-304	001 973	1/2"	7,0	1,1	4,2	0,6	4,6	0,7	HP Marking (CE Marking not required)		0,73	
A10-305	001 977	5/8"	10,5	1,6	6,0	0,9	7,0	1,1			0,93	
A12-305	001 978	5/8"	10,5	1,6	6,0	0,9	7,0	1,1			1,16	
A12-306	001 979	3/4"	14,0	2,1	8,1	1,2	9,1	1,4			1,16	
A14-305	001 980	5/8"	10,5	1,6	6,0	0,9	7,0	1,1			1,40	
A14-306	001 987	3/4"	14,0	2,1	8,1	1,2	9,1	1,4			1,40	
A06-405	001 989	5/8"	10,5	1,6	6,0	0,9	7,0	1,1			0,93	
A10-405	001 990	5/8"	10,5	1,6	6,0	0,9	7,0	1,1			1,75	
A10-406	001 994	3/4"	14,0	2,1	8,1	1,2	9,1	1,4			1,75	
A09-506	881 995	3/4"	14,0	2,1	8,1	1,2	9,1	1,4		Cat.I	Mod. D1*	2,33
A09-507	882 455	7/8"	25,6	3,8	14,0	2,1	16,1	2,4				2,33
A12-506	881 996	3/4"	14,0	2,1	8,1	1,2	9,1	1,4				3,29
A12-507	881 998	7/8"	25,6	3,8	14,0	2,1	16,1	2,4				3,29
A13-507	882 007	7/8"	25,6	3,8	14,0	2,1	16,1	2,4				3,80
A13-509	882 011	1-1/8"	41,4	6,2	25,3	3,8	26,7	4,0				3,80
A17-509	882 012	1-1/8"	41,4	6,2	25,3	3,8	26,7	4,0				4,87
A17-511	882 013	1-3/8"	66,0	9,9	37,6	5,6	42,8	6,4				4,87
A11-607	882 014	7/8"	25,6	3,8	14,0	2,1	16,1	2,4				4,30
A13-607	882 015	7/8"	25,6	3,8	14,0	2,1	16,1	2,4				4,98
A13-609	882 019	1-1/8"	41,4	6,2	25,3	3,8	26,7	4,0				4,98
A14-611	882 020	1-3/8"	66,0	9,9	37,6	5,6	42,8	6,4				5,48
A17-613	882 022	1-5/8"	100,0	15,0	59,7	9,0	63,9	9,6				6,85
A17-642	889 023	42 mm	100,0	15,0	59,7	9,0	63,9	9,6				6,85
A20-613	882 021	1-5/8"	100,0	15,0	59,7	9,0	63,9	9,6				8,21
A25-613	882 023	1-5/8"	100,0	15,0	59,7	9,0	63,9	9,6	Cat.II	Mod. D1	10,23	

* applied higher module as required.

Correction factor for other evaporating temperatures than nominal:

$$Q_n = Q_o \times K_t$$

Q_n : Nominal capacity

K_t : Correction factor for a pressure drop corresponding 1 K saturation temperature

Q_o : Required cooling capacity

Evaporating Temperature (°C)	+4	0	-5	-10	-15	-20	-25	-30	-35	-40
Correction Factor K _s	1,00	1,12	1,35	1,75	2,00	2,50	3,00	3,75	5,00	6,60

Ball Valves Series BVA / BVS

Features

- BVS version with access port connection
- Hermetic design
- Low leak rates below industry standard (certificate on request)
- Compatible with new refrigerants/lubricants
- Full internal ports reduce line pressure drops to a minimum
- Bi-directional flow characteristics
- Valve stem cap retained by strap attached to main body
- Pressure relief port in cap
- Manufactured and tested according EN 12284 and complies with Directive 97/23 EC
- CE and UL Marking



BVA



BVS

Type BVA			Type BVS with access port			Connection nominal size	Kv m ³ /hour	Max. Operating Pressure (bar)
Imperial	Metric	Part No.	Imperial	Metric	Part No.			
BVA-014		015 336	BVS-014		016 894	1/4" ODF	1.3	43 bar (Burst pressure 235 bar)
	BVA-M06	015 337		BVS-M06	016 895	6mm ODF	1.3	
BVA-038		015 338	BVS-038		016 910	3/8" ODF	3.2	
	BVA-M10	015 339		BVS-M10	016 896	10mm ODF	3.2	
BVA-012		015 340	BVS-012		016 897	1/2" ODF	7.2	
	BVA-M12	015 341		BVS-M12	016 898	12mm ODF	7.2	
BVA-058	BVA-M16	015 342	BVS-058	BVS-M16	016 899	5/8" / 16mm ODF	11.7	
BVA-034		015 343	BVS-034		016 900	3/4" ODF	18.2	
BVA-078	BVA-M22	015 344	BVS-078	BVS-M22	016 901	7/8" / 22mm ODF	29.6	
BVA-118		015 345	BVS-118		016 902	1 1/8" ODF	41.0	
	BVA-M28	015 346		BVS-M28	016 903	28mm ODF	41.0	31 bar (Burst pressure 215 bar)
BVA-138	BVA-M35	015 347	BVS-138	BVS-M35	016 904	1 3/8" / 35mm ODF	68.7	
BVA-158		015 348	BVS-158		016 905	1 5/8" ODF	92.0	
	BVA-M42	015 349		BVS-M42	016 906	42mm ODF	92.0	
BVA-218	BVA-M54	015 350	BVS-218	BVS-M54	016 907	2 1/8" / 54mm ODF	142.0	
BVA-258		015 351	BVS-258		016 908	2 5/8" ODF	152.0	
BVA-318		015 352	BVS-318		016 909	3 1/8" ODF	159.0	

Technical Data

Medium temperature TS	-40 to 150°C
Medium compatibility	HCFC and HFC
Oil compatibility	Mineral-, Synthetic and Polyolester (POE) lubricants.

Acid Test Kit Series AOK

Features

- Quick & easy test kit
- Universal acid test kit for use with all oils: Mineral, POE etc
- By changing the percentage of oil sample taken, the acid number of the oil can be accurately determined
- Phase separation of the chemicals in the kit provide a positive colour change regardless of the colour and condition of the oil



AOK

Type	Part No.
AOK-U01	804 166





















Accessories & Spare Parts

Cable Assemblies with Plug

ALCO offers cables with preconfigured plugs. This makes installation very easy and quick, only cable with crimped ends has to be connected.

The cable assemblies are available in various lengths for normal or low temperature applications:

Product Type	Cable length	Normal Temperature Range -25 .. +80 °C			Low Temperature Range -50 .. +80 °C		
		1.5m	3.0m	6.0m	1.5m	3.0m	6.0m
 ASC Solenoid Coils		ASC-N15 804 570	ASC-N30 804 571	ASC-N60 804 572	ASC-L15 804 573	ASC-L30 804 574	ASC-L60 804 575
 ASC 24V for DC applications		DS2-N15 804 620	DS2-N30 804 621	DS2-N60 804 622			
 EX4 ... EX8 new loose wires		EX5-N15 804 650	EX5-N30 804 651	EX5-N60 804 652			EX5-L60 804 655
 FSY Fan Speed Controls		FSF-N15 804 640	FSF-N30 804 641	FSF-N60 804 642	FSF-L15 804 643		
 FSP Power Module connection to FSE Control Module FSP 2-Pin Plug connection to EC2, EC3 or third Party Controllers		FSE-N15 804 680	FSE-N30 804 681	FSE-N60 804 682	FSE-L15 804 683	FSE-L30 804 684	FSE-L60 804 685
					FSP-L15 804 693	FSP-L30 804 694	FSP-L60 804 695
 OM3 / OM4 Relays cable OM3 / OM4 Power Cable			OM3-N30 805141	OM3-N60 805142			
				OM3-P30 805151	OM3-P60 805152		
 PT4 Pressure Transmitter					PT4-M15 804 803	PT4-M30 804 804	PT4-M60 804 805
 PS3 Pressure Controls		PS3-N15 804 580	PS3-N30 804 581	PS3-N60 804 582	PS3-L15 804 583	PS3-L30 804 584	PS3-L60 804 585



Electronic Controllers

Description	Type	Part No.
EC3 Replacement battery		807 790

Thermo - Expansion Valves

Description	Type	Part No.
Solder Adapter for TIS(E)		
Inlet 6 mm, ODF	X 99980	801 046
Inlet 10 mm, ODF	X 99981	801 049
Inlet 1/4", ODF	X 99982	801 047
Inlet 3/8", ODF	X 99983	801 048
Bulb clamp XB1019	XA 1728-4	803 260
Bulb clamp XC726	XA 1728-5	803 261
Service Tool for T Series	X 99999	800 005
Gasket Set for T, ZZ, L, 935 and TG Series Valves	X 13455 - 1	027 579
Bronze Screws for Following Flange Types: (ZZ-Valves)		
C500 , C501 , 9761 , X 6346 , X 6669, A576	Screw BZ 32	803 575
9148 , 9149, 9152 , 9153 , 10331 , 10332	Screw BZ 48	803 576
Steel Screws for Following Flange Types:		
C500 , C501 , 9761 , X 6346 , X 6669, A576	Screw ST 32	803 573
9148 , 9149, 9152 , 9153 , 10331 , 10332	Screw ST 48	803 574

Solenoid Valves

Description	Type	Part No.
Service Tool for 110RB, 240RA, 540RA, M36	X 11981 - 1	027 451
Plug acc. to DIN 43650 Cable Gland PG 9	GDM 2009 / PG9	801 012
Plug acc. to DIN 43650 Cable Gland PG 11	GDM 211 / PG11	801 013
Repair Kits:		
110RB	KS 30040-1	801 206
200RB	KS 30039/ KS 30109	801 205
240RA8	KS 30061	801 262
240RA9	KS 30062	801 263
240RA12	KS 30063	801 264
240RA16	KS 30065	801 200
240RA20	KS 30097	801 216
M36-078 / M36-118 / 3031 (upper assembly inc. gasket)	M36-UNF	801 440
Gasket Kits:		
110RB	KS 30040-2	801 232
200RB	KS 30039-1	801 233
240RA8	KS 30061-1	801 234
240RA9/12	KS 30062-1	801 235
240RA16	KS 30065-1	801 236
240RA20	KS 30097-1	801 237
all 3031	KS 30177-1	801 268

Pressure Controls

Description	Type	Part No.
Mounting Bracket, Angle, including screws Universal for PS1, PS2, FD 113		803 799
Mounting Bracket Universal		803 798
Extension Bracket for PS1, PS2		803 800
Mounting Plate for units with hood		803 801
Plug acc. to DIN 43650 for PS3		
Cable Gland PG 9		801 012
Cable Gland PG 11		801 013
Terminal Cover for PS3		
Top Cable Entry		803 774
Side Cable Entry		803 775
Capillary Tube with Flare Nuts $\frac{7}{16}$ "-20 UNF, $\frac{1}{4}$ " SAE, 1.5m		803 804
Copper Gasket Set (100 pcs) for R1/4" ($\frac{7}{16}$ "-20 UNF, female)		803 780

Thermostats

Description	Type	Part No.
Mounting Bracket Angle		803 799
Universal Mounting Bracket		803 798
Mounting Angle for TS1-G, -H		803 805
Extension Bracket for TS1		803 800
Insulation Console TS1 Standard		803 777
Capillary Tube Glands R $\frac{1}{2}$ " thread, for bulb style A/C		803 807
Capillary Tube Holder (5 pcs)		803 778
Capillary Tube with Flare Nuts $\frac{7}{16}$ "-20 UNF, $\frac{1}{4}$ " SAE, 1.5m		803 804

Oil Management

Description	Type	Part No.
OM3/ Flange adapter 3- / 4-hole	OM0-CUA	805 037
OM4 Screw adapter 1 1/8"-18 UNEF	OM0-CBB	805 038
Screw adapter 3/4"-14 NPTF	OM0-CCA	805 039
Screw adapter 1-1/8"-12 UNF	OM0-CCB	805 040
Flange adapter 3-hole	OM0-CCC	805 041
Rotalock adapter 1-3/4"-12UNF	OM0-CCD	805 042
Solenoid coil 24 VAC, 50/60 Hz, 15VA	ASC 24VAC	801 052
Transformer 230 VAC / 24VAC, 25 VA	ECT-323	804 424
Transformer 230 VAC / 24VAC, 60 VA	ECT-623	804 421
Differential oil check valve 3.5 bar (Inlet 5/8"-UNF female, outlet 5/8"-UNF male)	ODP-33A	800 366
Repair Kit for all OM3/OM4 types (all necessary gaskets, coil clip and oil adapter with screen)	OM3-K01	805 036
Teflon gasket set 1-3/4"-UNF (100 pcs) as used in OM3-CCD and OM4-CCD	DS10134	400 000 11
OS Gasket Set for OSB / OST (50 pcs)	X 99956	007 591



Filter Driers

Description	Type	Part No.
all ADKS, ADKS-Plus, FDS		
Gasket Set	X 99961	003 710
Screw Set	X 99997	803 325
Schrader Nipple 1/4" NPT	X 11562-2	803 251
Core Holder	X 99963	003 712
FDS 48		
O'Ring Set	X 99962	003 711
Shell Holder	X 99965	003 714
FDS 24		
Gasket Set	X 99967	003 716
O'Ring Set	X 99968	003 717
Core Holder	X 99969	003 718
Shell Holder	X 99970	003 719
BTAS		
Spring BTAS 2 (Package with 10 pieces)	KD 40009	064 790
Spring BTAS 3 (Package with 10 pieces)	KD 40010	064 813
Spring BTAS 4 (Package with 10 pieces)	KD 40011	064 814
Spring BTAS 5 (Package with 10 pieces)	KD 40007	064 443
Cover Plate Gasket BTAS 2	PS 23380-2	053 580
Cover Plate Gasket BTAS 3	PS 23380-3	053 581
Cover Plate Gasket BTAS 4	PS 23380-4	053 582
Cover Plate Gasket BTAS 5	PS 23380-5	053 583

Indicators

Description	Type	Part No.
AMI Upper Part with Indicator	X 12978-1	805 742
O'Rings 20 pcs	X 99995	805 643



Appendix

Conversion Table

Power

kW / h = Kcal / h : 860	Kcal / h = kW / h x 860
kW = US ton of refrigeration : 0,284	US ton of refrigeration = kW x 0,284
kW = BTU / h : 3413	BTU / h = kW x 3413

Temperature

°C = (°F - 32) : 1,8	°F = (°C x 1,8) + 32
----------------------	----------------------

Pressure

bar = PSI : 14,5	PSI = bar x 14.5
1 bar = 100 000 Pascal	100 Pascal = 1 mbar

Connections

Specification		Connection Tube			Thread	
		SAE	inch	metric		
SAE	Flare	SAE 1/4"	1/4"	6mm	7/16" - 20 UNF	
		SAE 5/16"	5/16"	8mm	5/8" - 18 UNF	
		SAE 3/8"	3/8"	10mm	5/8" - 18 UNF	
		SAE 1/2"	1/2"	12mm	3/4" - 16 UNF	
		SAE 5/8"	5/8"	16mm	7/8" - 14 UNF	
		SAE 3/4"	3/4"	18mm	1-1/16 - 14 UNF	
		SAE 7/8"	7/8"	22mm	1-1/4 - 12 UNF	
		SAE 1"	1"	25mm	1-1/2 - 12 UNF	
				1-1/8"		
				1-3/8"	35mm	
		1-5/8"				
		2-1/8"	54mm			
		2-5/8"				
		3-1/8"				
R or G same as BSP	Pipe Thread female cylindrical	Male Thread : R / NPT / BSP / G			Withworth- Pipe Thread DIN 2999 / ISO 228	
R same as BSP	Pipe Thread male tapering	Female Thread : R / NPT / BSP / G			Withworth- Pipe Thread DIN 2999	
G	Pipe Thread male cylindrical	Female Thread : R / BSP / G			Withworth- Pipe Thread ISO 228	
NPT	Pipe Thread female tapering	Male Thread : R / NPT / BSP			Standard Taper Pipe Thread ASA B 2.1	
	Pipe Thread male tapering	Female Thread : R / NPT / BSP / G				
ODF Outside Diameter Female	Solder female	Given dimension is outside tube diameter. Tube has to be pushed into ODF connection.				
ODM Outside Diameter Male	Solder male	Given dimension is outside tube diameter. Expanded tube can be pushed onto ODM connection or tube can be connected through a sleeve with the ODM connection.				



Saturation Pressure Table for Refrigerants

(bar, absolute)

Temperature °C	R 410A	R 134a	R 22	R 404 A		R 507	R 407 C		R 23	ALCO-Symbol B	Temp. °C
	ALCO-Symbol										
	Q	M	H	S		S	N				
				Liquid	Vapor		Liquid	Vapor			
85		29,29	40,29						47,24	25	
80		26,35	36,52						41,84	20	
75		23,65	33,04						36,97	15	
70		21,17	29,83	33,34	33,01				32,58	10	
65		18,89	26,87	31,95	31,84	32,91			28,62	5	
60	38,44	16,81	24,15	28,75	28,63	29,59			25,04	0	
55	34,47	14,91	21,64	25,80	25,66	26,54	24,91	22,48	21,83	-5	
50	30,79	13,17	19,33	23,08	22,94	23,73	22,24	19,88	18,94	-10	
45	27,41	11,59	17,21	20,58	20,44	21,14	19,79	17,52	16,35	-15	
40	24,31	10,16	15,27	18,29	18,15	18,78	17,55	15,39	14,03	-20	
35	21,47	8,87	13,50	16,20	16,06	16,62	15,50	13,46	11,97	-25	
30	18,90	7,70	11,88	14,29	14,15	14,65	13,63	11,73	10,14	-30	
25	16,56	6,65	10,41	12,55	12,42	12,86	11,93	10,17	8,53	-35	
20	14,45	5,72	9,08	10,98	10,85	11,24	10,41	8,78	7,12	-40	
15	12,55	4,88	7,88	9,56	9,44	9,78	9,03	7,54	5,89	-45	
10	10,85	4,15	6,80	8,28	8,17	8,47	7,79	6,44	4,83	-50	
8	10,22	3,88	6,40	7,80	7,70	7,98	7,33	6,03	4,45	-52	
6	9,62	3,62	6,02	7,35	7,25	7,52	6,90	5,65	4,09	-54	
4	9,04	3,38	5,66	6,92	6,82	7,08	6,48	5,28	3,75	-56	
2	8,49	3,15	5,31	6,51	6,41	6,65	6,09	4,94	3,44	-58	
0	7,97	2,93	4,98	6,11	6,01	6,25	5,71	4,61	3,14	-60	
-2	7,48	2,72	4,66	5,74	5,64	5,86	5,34	4,30	2,87	-62	
-4	7,00	2,53	4,36	5,38	5,29	5,50	5,00	4,00	2,61	-64	
-6	6,55	2,34	4,08	5,04	4,95	5,15	4,68	3,72	2,37	-66	
-8	6,12	2,17	3,81	4,71	4,63	4,82	4,37	3,46	2,15	-68	
-10	5,72	2,01	3,55	4,40	4,32	4,50	4,08	3,21	1,95	-70	
-12	5,33	1,86	3,31	4,11	4,03	4,20	3,80	2,97	1,76	-72	
-14	4,97	1,71	3,08	3,83	3,76	3,92	3,53	2,75	1,58	-74	
-16	4,62	1,58	2,86	3,57	3,50	3,65	3,29	2,54	1,42	-76	
-18	4,29	1,45	2,65	3,32	3,25	3,40	3,05	2,34	1,28	-78	
-20	3,98	1,33	2,46	3,09	3,02	3,15	2,83	2,16	1,14	-80	
-22	3,69	1,22	2,27	2,86	2,80	2,93	2,62	1,99	1,02	-82	
-24	3,42	1,12	2,10	2,65	2,59	2,71	2,42	1,82	0,90	-84	
-26	3,16	1,02	1,94	2,46	2,40	2,51	2,23	1,67	0,80	-86	
-28	2,91	0,93	1,78	2,27	2,21	2,32	2,06	1,53	0,71	-88	
-30	2,68	0,85	1,64	2,10	2,04	2,14	1,89	1,40	0,62	-90	
-32	2,47	0,77	1,51	1,93	1,88	1,98	1,74	1,28	0,55	-92	
-34	2,27	0,70	1,38	1,78	1,73	1,82	1,60	1,16	0,48	-94	
-36	2,08	0,63	1,26	1,63	1,58	1,67	1,46	1,05	0,42	-96	
-38	1,90	0,57	1,16	1,49	1,45	1,53	1,34	0,96	0,36	-98	
-40	1,74	0,52	1,05	1,37	1,33	1,40	1,22	0,87	0,32	-100	
-42	1,58	0,47	0,96	1,25	1,21	1,28	1,11	0,78	0,27	-102	
-44	1,44	0,42	0,87	1,14	1,10	1,17	1,01	0,70	0,23	-104	
-46	1,31	0,37	0,79	1,04	1,00	1,07	0,92	0,63	0,20	-106	
-48	1,18	0,34	0,72	0,94	0,91	0,97	0,83	0,57	0,17	-108	
-50	1,07	0,30	0,65	0,85	0,82	0,88	0,75	0,51	0,14	-110	
-52	0,96	0,27	0,58	0,77	0,74	0,80	0,68	0,45	0,12	-112	
-54	0,87	0,24	0,52	0,70	0,67	0,72	0,61	0,40	0,10	-114	
-56	0,78	0,21	0,47	0,63	0,60	0,65	0,55	0,36	0,09	-116	
-58	0,70	0,19	0,42	0,56	0,54	0,59	0,49	0,32	0,07	-118	
-60	0,62	0,16	0,38	0,51	0,48	0,53	0,44	0,28	0,06	-120	

The pressure values required for selection of R 404A and R 407C expansion valves are shown shaded.

CE per Pressure Vessel Directive CE 97 / 23 / EC

Filter Driers

Product	Fluid group	Volume (liter)	TS (°C)	PS (bar)	Hazard category	Conformity assessment module	Marking
ADK-03 / 05 / 08 / 16...	II	0.1 ... 0.38	-40 ... +65	43	SEP	-	HP & UL
ADK-30 / 41 / 75...	II	0.4 ... 0.65		43	SEP	-	HP & UL
FDB-03 / 05 / 08 / 16...	II	0.1 ... 0.38		43	SEP	-	HP & UL
FDB-30 / 41...	II	0.45 ... 0.5		43	SEP	-	HP & UL
BFK-05 / 08 / 16...	II	0.18 ... 0.32		43	SEP	-	HP & UL
BFK-30...	II	0.4		43	SEP	-	HP & UL
FDS-24...	II	1.0	-10 ... +65 (-45 ... -10)	34.5 (25.9)	SEP	-	HP & UL
ADKS / FDS-48...	II	2.1			I	D1	CE0036 & UL
ADKS / FDS-96...	II	3.8			I	D1	CE0036 & UL
ADKS / FDS-144...	II	5.4			I	D1	CE0036 & UL
ADKS / FDS-192...	II	7.0			II	D1	CE0036 & UL
ASD/ASF-28.../35.../ 45...	II	<1.0	-45 ... +50	27.5	SEP	-	HP & UL
ASD/ASF50.../75...	II	<1.4			SEP	-	HP & UL
BTAS-2...	II	0.42	-45 ... +50	24	SEP	-	HP & UL
BTAS-3...	II	1.1			SEP	-	HP & UL
BTAS-4...	II	1.97			SEP	-	HP & UL
BTAS-5...	II	3.19			I	A	CE & UL

Oil management / components

OSH-404	II	2.0	-40 ... +65	34.1	I	D1	CE0036 & UL
OSH-405	II	2.4			I	D1	CE0036 & UL
OSH-407	II	2.8			I	D1	CE0036 & UL
OSH-409	II	3.0			I	D1	CE0036 & UL
OSH-411 / -413	II	3.6			I	D1	CE0036 & UL
OST-404	II	1.8			I	D1	CE0036 & UL
OST-405	II	2.6			I	D1	CE0036 & UL
OST-407	II	3.2			I	D1	CE0036 & UL
OST-409 / -411 / -413	II	3.8			I	D1	CE0036 & UL
OSH-611	II	6.5	-40 ... +65	44.3	II	D1	CE0036 & UL
OSH-613 / -617	II	7.9			II	D1	CE0036 & UL
OSB-613 / -617	II	7.8			II	D1	CE0036 & UL
OSC-2...	II	6.4	-10 ... +150		I	D1	CE0036 & UL
OSC-3...	II	8.9			II	D1	CE0036 & UL
OSC-4...	II	12.8			II	D1	CE0036 & UL
OSC-5...	II	14.1			II	D1	CE0036 & UL
OSC-6...	II	23.2			II	D1	CE0036 & UL
ORV-043	II	16.0			II	D1	CE0036 & UL
ORV-023	II	7.7			II	D1	CE0036 & UL
OM3	II	DN 6mm	-20 ... +80°C	31	SEP	CE under Low Voltage and EMC Directive	
OM4	II	DN 6mm	-20 ... +80°C	43	SEP	CE under Low Voltage and EMC Directive	

Suction accumulators

A08-304	II	0.9	-10 ... +65 (-45 ... -10)	20.7 (15.5)	SEP	-	HP & UL
A10-305	II	1.1			SEP	-	HP & UL
A12-305 / -306	II	1.3			SEP	-	HP & UL
A14-305 / -306	II	1.6			SEP	-	HP & UL
A06-404 / -405	II	1.2			SEP	-	HP & UL
A10-405 / -406	II	2.1			SEP	-	HP & UL

Suction accumulators (continuation)

Product	Fluid group	Volume (liter)	TS (°C)	PS (bar)	Hazard category	Conformity assessment module	Marking
A09-506 / -507	II	2.7	-10 ... +65 (-45 ... -10)	20.7 (15.5)	I	D1	CE0036 & UL
A12-506 / -507	II	3.8			I	D1	CE0036 & UL
A13-507 / -509	II	4.3			I	D1	CE0036 & UL
A17-509 / -511	II	5.4			I	D1	CE0036 & UL
A11-607	II	5.1			I	D1	CE0036 & UL
A13-607 / -609	II	5.8			I	D1	CE0036 & UL
A14-611	II	6.4			I	D1	CE0036 & UL
A17-613	II	7.9			I	D1	CE0036 & UL
A20-613	II	9.4			I	D1	CE0036 & UL
A25-613	II	11.6			II	D1	CE0036 & UL

Pressure switches

Product	Fluid group	DN (mm)	TS (°C)	PS (bar)	Hazard category	Conformity assessm. module	Marking		
PS1-B3..., PSA-B3...		6	-50 ... +70	22	IV	B, D	CE0035		
PS1-S3..., PSA-S3...		6			IV	B, D	CE0035		
PS1-W3..., PSA-W3...		6			IV	B, D	CE0035		
PS1-B5..., PSA-B5...		6		32	IV	B, D	CE0035		
PS1-S5..., PSA-S5...		6			IV	B, D	CE0035		
PS1-W5..., PSA-W5...		6			IV	B, D	CE0035		
All other PS1 types		6			22/32	Under LVD, excluded from PED		CE	
PS2-B7..., PSB-B7...				6	-50 ... +70	22	IV	B, D	CE0035
PS2-C7..., PSB-C7...	6		IV	B, D			CE0035		
PS2-T7..., PSB-T7...	6		IV	B, D			CE0035		
PS2-B7..., PSB-B7...	6		32	IV		B, D	CE0035		
PS2-C7..., PSB-C7...	6			IV		B, D	CE0035		
PS2-C8..., PSB-C8...	6			IV		B, D	CE0035		
PS2-G8..., PSB-G8...	6			IV		B, D	CE0035		
PS2-S8..., PSB-S8...	6			IV		B, D	CE0035		
PS2-T7..., PSB-T7...	6			IV		B, D	CE0035		
PS2-W7..., PSB-W7...	6			IV		B, D	CE0035		
All other PS2 types	6		22/32	Under LVD, excluded from PED		CE			
PS3-B.1...,PS3-W.1...			6	-40 ... +70		27	IV	B, D	CE0035
PS3-B.4...,PS3-S.4...			6	-40 ... +70		32	IV	B, D	CE0035
PS3-B.5...,PS3-S.5...			6				IV	B, D	CE0035
PS3-W.4...,PS3-W.5...		6	IV		B, D		CE0035		
PS3-C.4...,PS3-T.4...,PS3-X.4...		6	-40 ... +150	43	IV	B, D	CE0035		
PS3-C.5...,PS3-T.5...,PS3-X.5...		6	IV		B, D	CE0035			
PS3-B6...,PSC-B6...		6	-40 ... +150	43	IV	B, D	CE0035		
PS3-W6...,PSC-W6...		6			IV	B, D	CE0035		
PS3-S6...,PSC-S6...		6			IV	B, D	CE0035		
All other PS3 type		6	-40 ... +70	27/32	Under LVD, excluded from PED		CE		
FD113...			6	Under LVD, excluded from PED			CE		

LVD = Low Voltage Directive

Fan speed Controllers

Product	Fluid group	DN (mm)	TS (°C)	PS (bar)	Hazard category	Conformity assessment module	Marking
FSY-41...	II	6	-20 ... +70	28	under LVD, excluded from PED		CE
FSY-42...	II	6		32			CE
FSY-43...	II	6		43			CE

Transmitters

PT4-07M	II	6	-50 ... +135	25	SEP	-	-
PT4-18M / 30M	II	6		33	SEP	-	-
PT4-50M	II	6		50	SEP	-	-

Thermo® Expansion Valves and Electrical Control Valves

TI	II	max. 16	-45 ... +65	31	SEP	-	-
TX3	II	max. 16		43.8	SEP	-	-
TX6-H/M/N/S..	II	max. 22		31	SEP	-	-
TX6-Z..	II	max. 22		42	SEP	-	-
T-series	II	max. 28		31	SEP	-	-
L-series	II	max. 28		31	SEP	-	-
935-series	II	max. 28		31	SEP	-	-
ZZ-series	II	max. 28	-120 ... +65	31	SEP	-	-
EX2	II	max. 12	-40 ... +50	40	SEP	-	-
EX4/EX5/EX6	II	max. 22	-50 ... +65	45	SEP	-	-
EX7	II	35		45	I	A	CE
EX8	II	42		35	I	A	CE

Solenoid valves

110 RB 2...	II	6 ... 10	-40 ... +120	35	SEP	-	-
200 RB 3/4/6...	II	10 ... 16		35	SEP	-	-
240 RA 8/9/12...	II	16 ... 28		35	SEP	-	-
240 RA 16T9	II	28		35	SEP	-	-
240 RA 16T11	II	35		31	I	A	CE
240 RA 20T11/13/17...	II	35 ... 54		31	I	A	CE
540 RA 8/9/12/16...	II	16 ... 28		35	SEP	-	-
540 RA 20T11	II	35 ... 54		28	SEP	-	-
M36-078	II	28		-40 ... +120	35	SEP	-
M36-118	II	28	35		SEP	-	-

Regulators

ACP	II	6 ... 10	-40 ... +120	31	SEP	-	-
CPHE...	II	12 ... 28		28	SEP	-	-
HP5/8/14...	II	12 ... 35		28	SEP	-	-
PRE/PRC	II	16 ... 35	-30 ... +80	25	SEP	-	-

Ball valves

BVA/BVS...	II	≤ 28	-40 ... +150	43	SEP	-	-
BVA/BVS....	II	> 28		31	I	A	CE

Hazard Category: SEP = Sound Engineering Practice acc. to art. 3.3 of PED.

Emerson Electric GmbH & Co. OHG Alco Controls

Heerstr. 111 - 71332 Waiblingen / Germany

Tel.: +49 7151 509-0 Fax: +49 7151 509-200 email ALCO.Service@emerson.com

www.emersonclimate.eu

The Emerson Climate Technologies logo is a trademark and service mark of Emerson Electric Co.
All other trademarks are property of their respective owners.
Information contained in this brochure is subject to change without notification.
(C) 2008 Emerson Electric GmbH & Co.OHG

