



M.P.M.
PLASTIC MATERIALS EXTRUSION

Profile PVC do chłodziń oraz lad chłodniczych





M.P.M.
PLASTIC MATERIALS EXTRUSION

S p i s t r e ś c i

1 - SYSTEM STANDARDOWY	strona	5
2 - SYSTEM SZYBKIEGO MONTAŻU	strona	9
3 - SYSTEM CLEAN	strona	13
4 - SYSTEM MODULARNY	strona	17
5 - PROFILE PODŁOGOWE DO PŁYT WARSTWOWYCH	strona	23
6 - SYSTEM PILLAR DO PŁYT WARSTWOWYCH	strona	26
7 - LISTWY PRZYPODŁOGOWE - SYSTEM KERB	strona	29
8 - LISTWY PRZYPODŁOGOWE WYSOKIE (400 mm)	strona	31
9 - SYSTEM PROFILI DRZWIOWYCH	strona	33
10 - AKCESORIA DO PŁYT WARSTWOWYCH	strona	37
11 - ODBOJE h = 50	strona	40
12 - ODBOJE h = 80	strona	42
13 - ODBOJE ELASTYCZNE h = 80	strona	44
14 - ODBOJE - SYSTEM MODULARNY	strona	46
15 - ODBOJE - ZABEZPIECZENIA ŚCIAN (100-150 mm)	strona	48
16 - ODBOJE MIĘKKIE 150	strona	51
17 - USZCZELKI DO LAD CHŁODNICZYCH	strona	53

NAROŻNIK wewnętrzny:

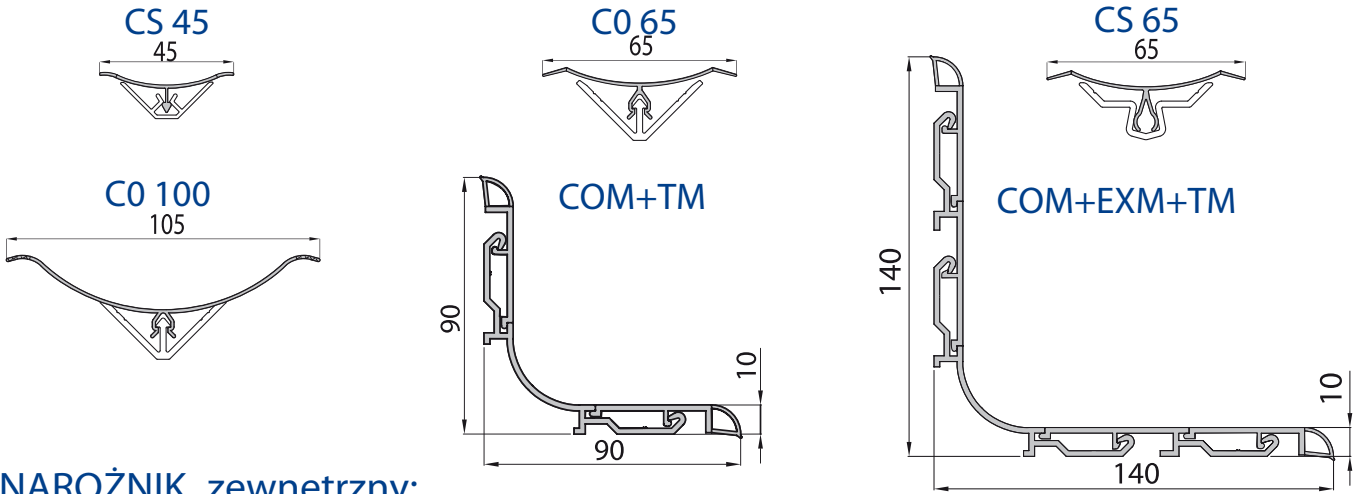

NAROŻNIK zewnętrzny:

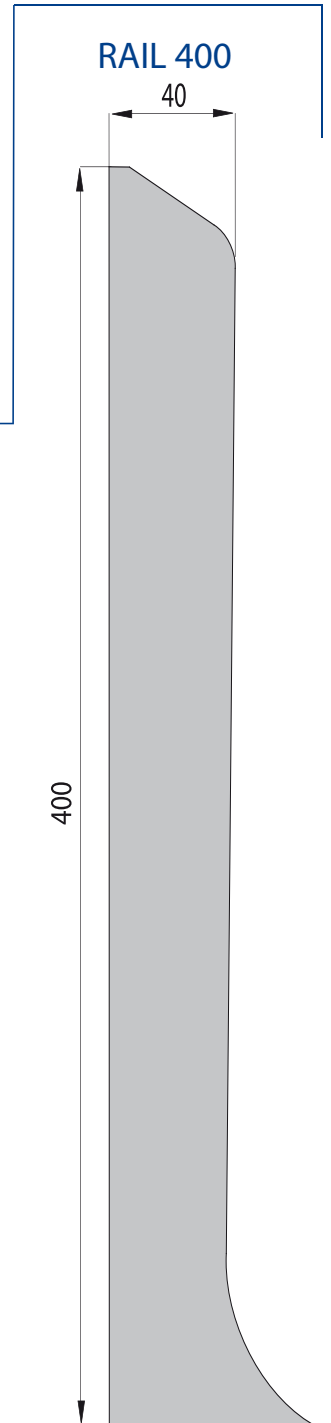
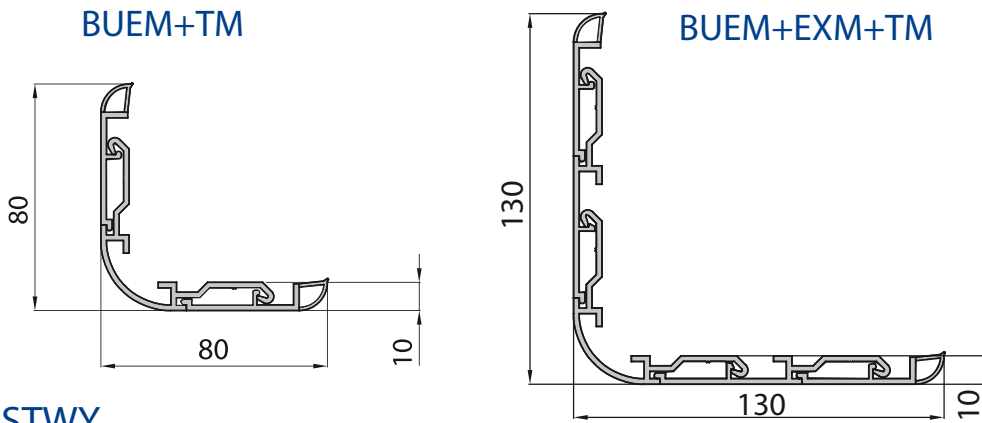

LISTWY

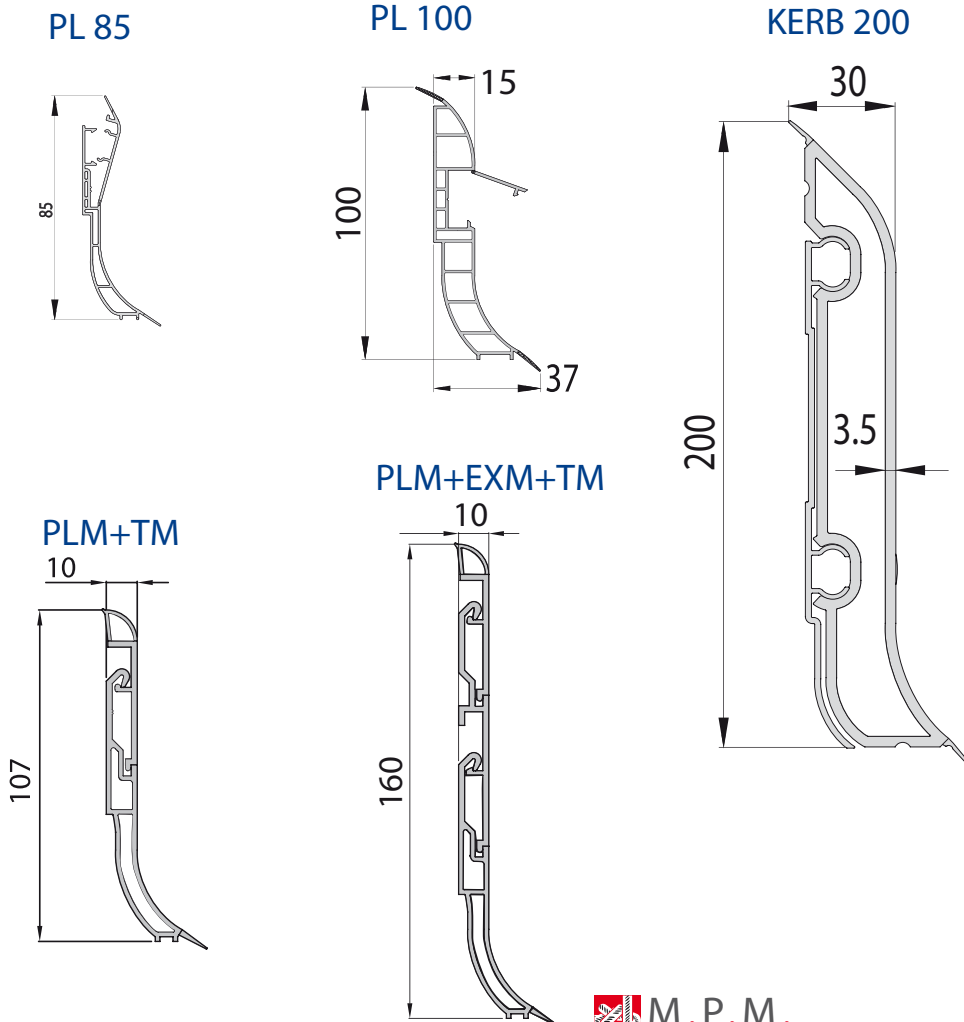

ODBOJE:

BU50+BUPF50

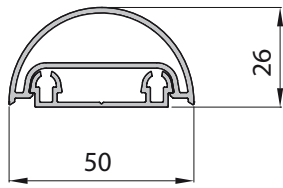

BU80+BUC80

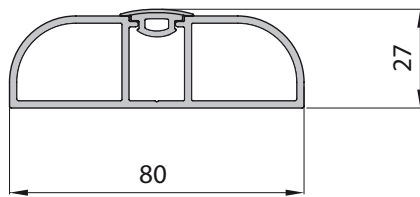

BE80+BEC80

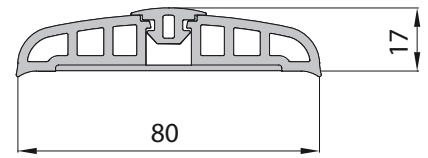

BES 80
80

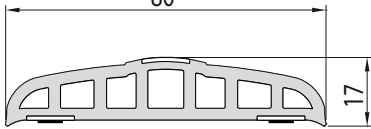

WP100+WPC

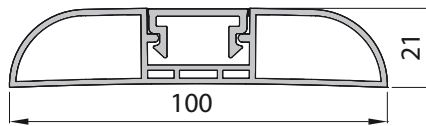

WP150+WPC

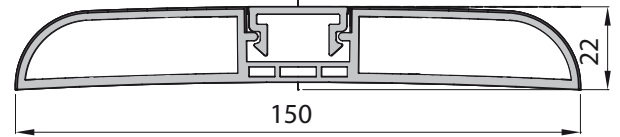

BUM+TM

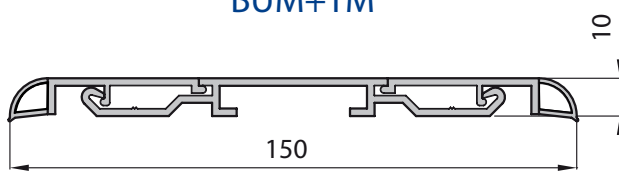

BU150+BUAF

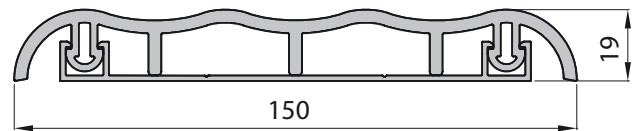

BUM+EXM+TM

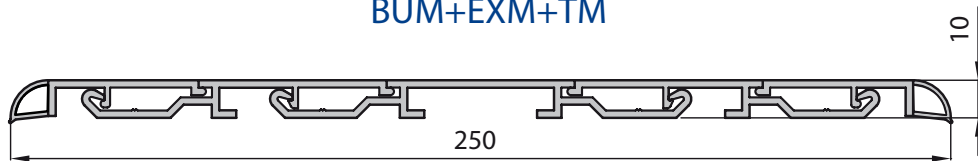

PROFILE STARTOWE DO PŁYT WARSTWOWYCH:

CH 60

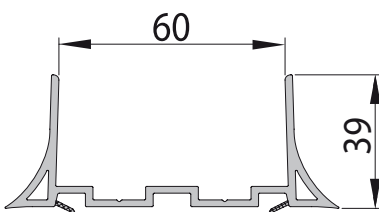

CH 70

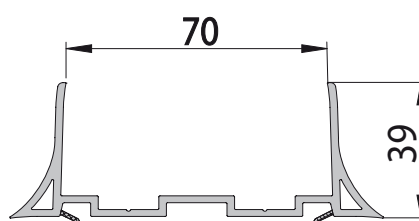

CH 80

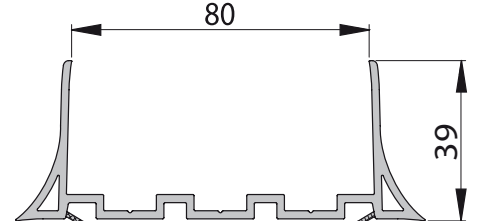

CH 100
100

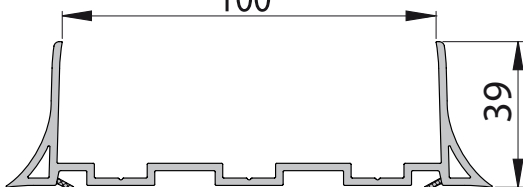

CH 120
120

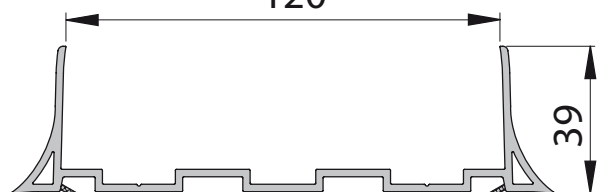

CU 60
60

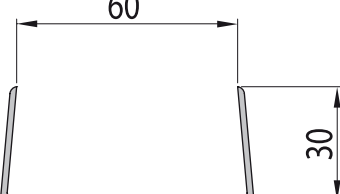

CU 80
80

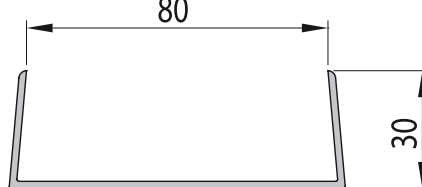

CU 100
100

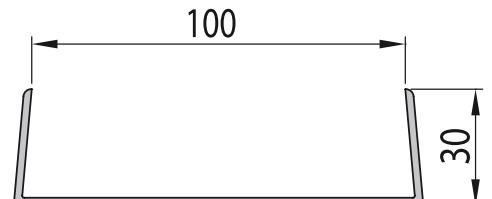

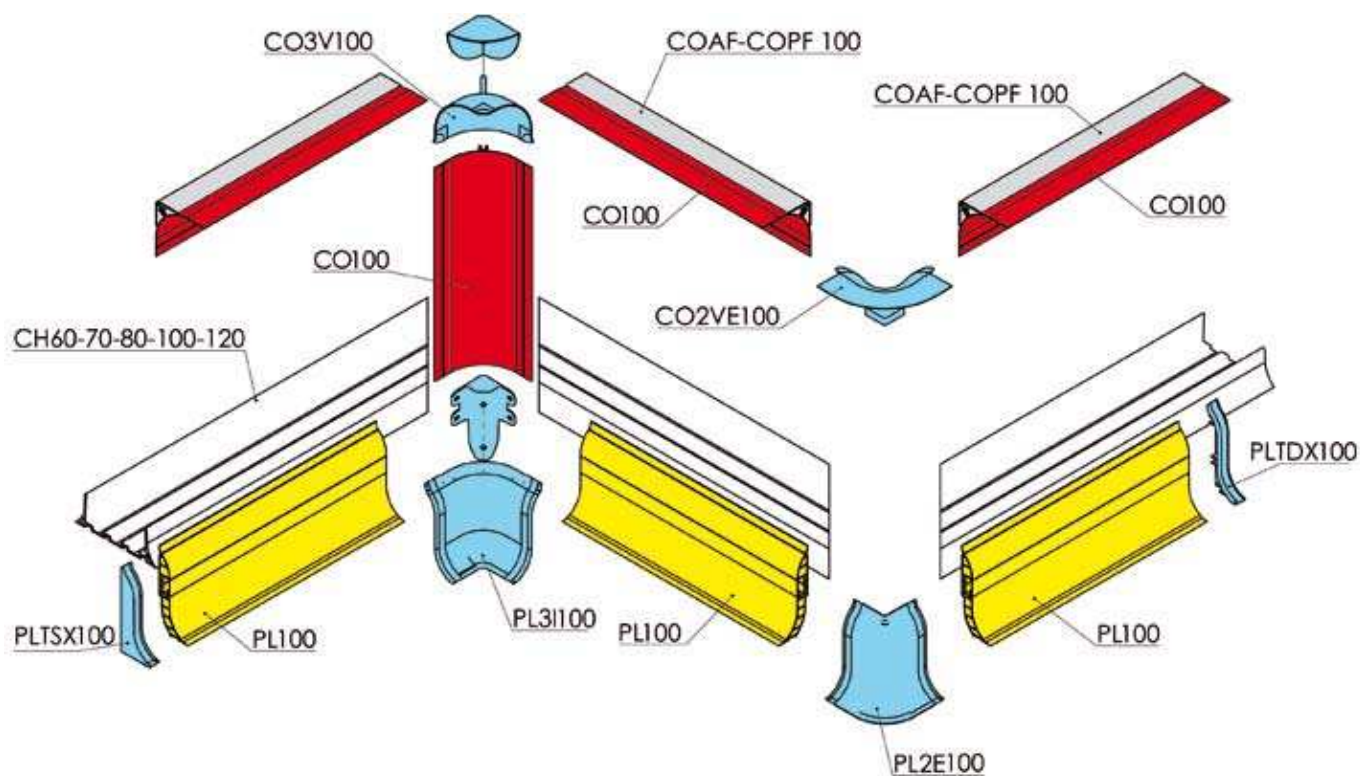

1. System standardowy

Standardowy system wykończeń wyoblonych zgodny z wymogami zasad sanitarno - higienicznych, z miękkim wykończeniem dopasowującym się do podłoża i pozwalającym zachować większą czystość pomieszczeń.

Może być używany w połączeniu z listwami płaskimi PL100.

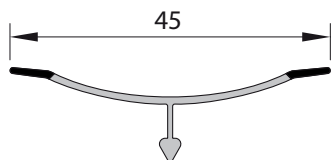

CS 45

Materiał	wielokomponentowe pvc
Kolor	Ral 9010 / 9002
Długość	4.000 mm
Opakowanie	50 szt./ pudełko

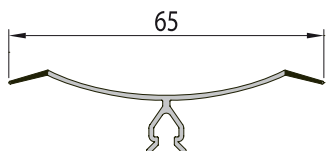

CO 65

Materiał	wielokomponentowe pvc
Kolor	Ral 9010 / 9002
Długość	4.000 mm
Opakowanie	25 szt./ pudełko

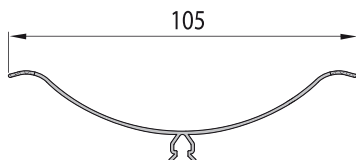

CO 100

Materiał	wielokomponentowe pvc
Kolor	Ral 9010 / 9002
Długość	4.000 mm
Opakowanie	25 szt./ pudełko

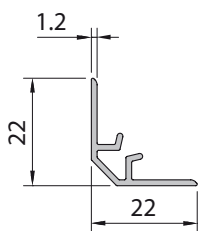

CSP 45

Materiał	twarde pvc
Kolor	-----
Długość	4.000 mm
Opakowanie	50 szt./ pudełko

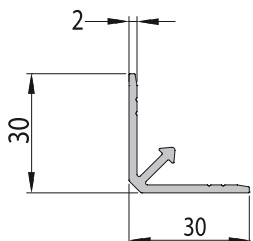

COPF 100-65

z otworami pod wkręty

Materiał	twarde pvc
Kolor	-----
Długość	4.000 mm
Opakowanie	25 szt./ pudełko

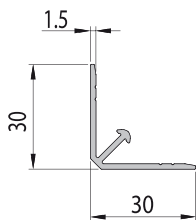

COAF 100-65

Materiał	aluminium
Kolor	aluminium
Długość	4.000 mm
Opakowanie	25 szt./ paczka

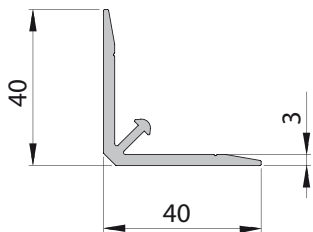
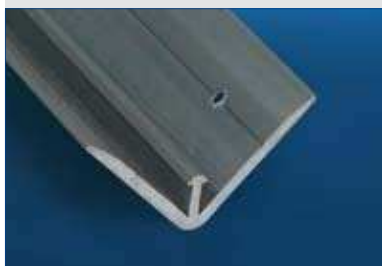

COPF 40 Z otworami pod wkręty

Materiał	hard pvc
Kolor	various
Długość	4.000 mm
Opakowanie	25 szt./ pudełko

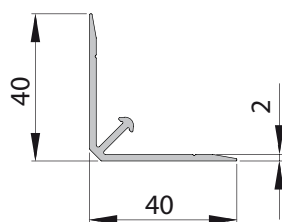

COAF 40 Z otworami pod wkręty

Materiał	aluminium
Kolor	aluminium
Długość	4.000 mm
Opakowanie	25 szt./ paczka

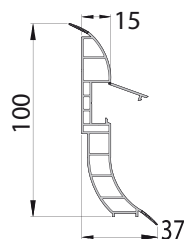

PL 100

Materiał	wielokomponentowe pvc
Kolor	Ral 9010 / 9002
Długość	4.000 mm
Opakowanie	12 szt./ pudełko

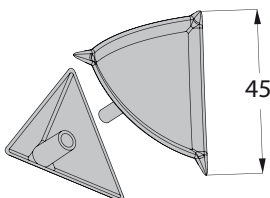

CO3V 45

Materiał	twarde pvc
Kolor	Ral 9010 / 9002
Opakowanie	100 szt. / pudełko

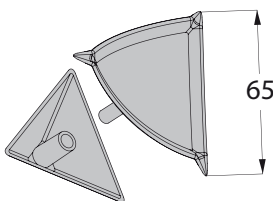

CO3V 65

Materiał	twarde pvc
Kolor	Ral 9010 / 9002
Opakowanie	100 szt. / pudełko

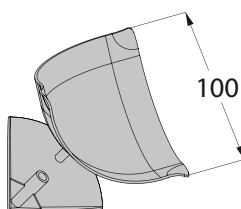

CO3V 100

Materiał	polipropylen
Kolor	Ral 9010 / 9002
Opakowanie	100 pcs./ pudełko

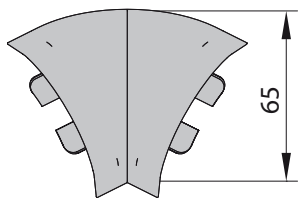

CO2VE 65

Materiał	twarde pvc
Kolor	Ral 9010 / 9002
Opakowanie	100 szt./ pudełko

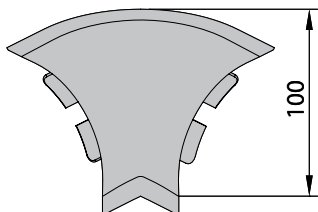

CO2VE 100

Materiał	twarde pvc
Kolor	Ral 9010 / 9002
Opakowanie	100 szt./ pudełko

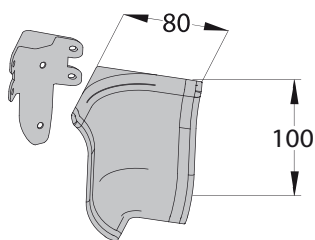

PL2I 100

Materiał	twarde pvc
Kolor	Ral 9010 / 9002
Opakowanie	50 szt./ pudełko

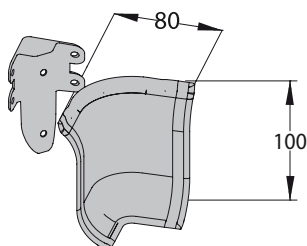

PL3I 100

Materiał	twarde pvc
Kolor	Ral 9010 / 9002
Opakowanie	50 szt./ pudełko

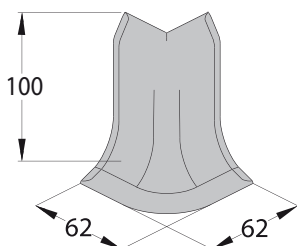

PL2E 100

Materiał	twarde pvc
Kolor	Ral 9010 / 9002
Opakowanie	50 szt./ pudełko

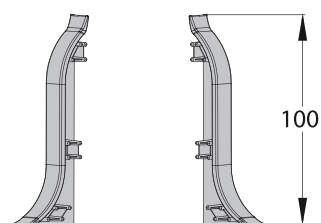

PLTDX 100 / PLTSX 100

Materiał	twarde pvc
Kolor	Ral 9010 / 9002
Opakowanie	100 szt./ pudełko



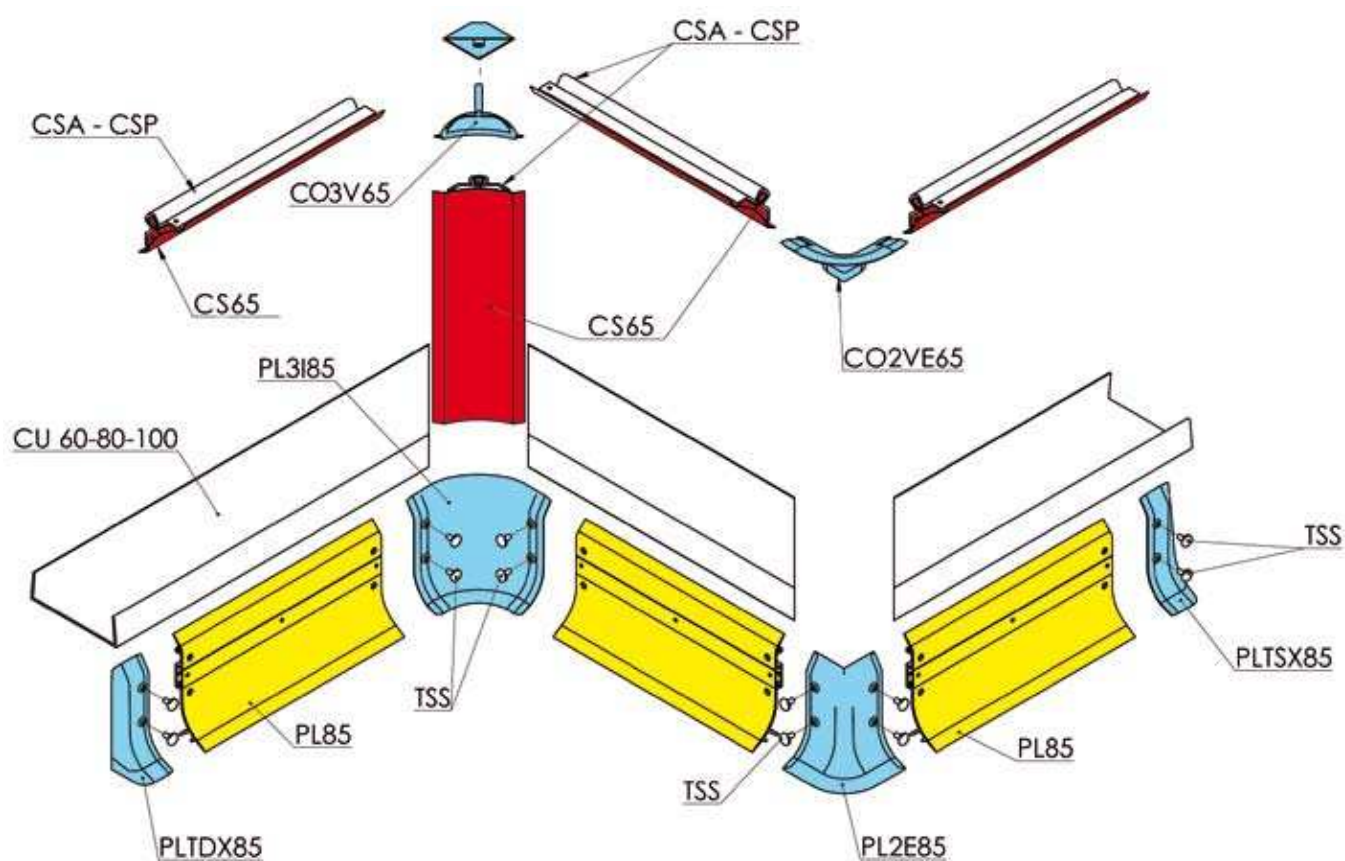

2. System szybkiego montażu

*tylko z profilami startowymi CU

System wykończeń wyoblonych do szybkiego i łatwego montażu,
z otworami montażowymi na poszczególnych elementach.

System przeznaczony do profili startowych CU dla płyt warstwowych.

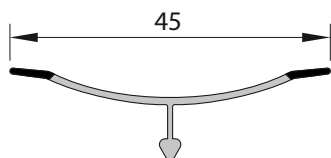

CS 45

Materiał	wielokomponentowe pvc
Kolor	Ral 9010 / 9002
Długość	4.000 mm
Opakowanie	50 szt./ pudełko

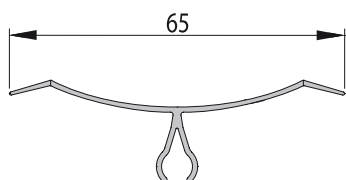

CS 65

Materiał	wielokomponentowe pvc
Kolor	Ral 9010 / 9002
Długość	4.000 mm
Opakowanie	25 szt./ pudełko

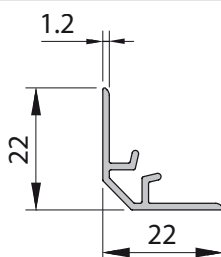

CSP 45

Materiał	twarde pvc
Kolor	-----
Długość	4.000 mm
Opakowanie	50 szt./ pudełko

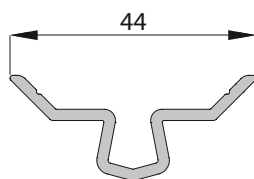

CSP

Z otworami pod wkręty

Materiał	twarde pvc
Kolor	-----
Długość	4.000 mm
Opakowanie	25 szt./ pudełko

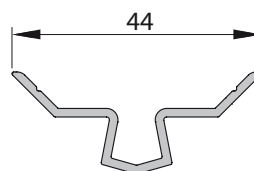

CSA

Materiał	aluminium
Kolor	aluminium
Długość	4.000 mm
Opakowanie	25 szt./ paczka

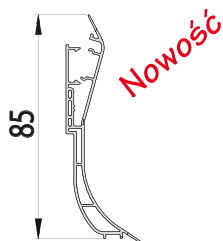

PL 85 R

Materiał	wielokomponentowe pvc
Kolor	Ral 9010 / 9002
Długość	4.000 mm
Opakowanie	14 szt./ pudełko

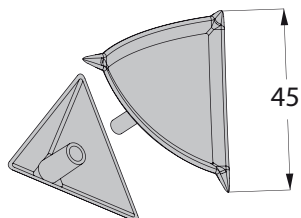
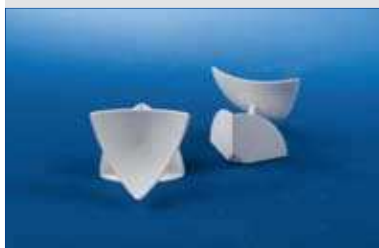

CO3V 45

Materiał	twarde pvc
Kolor	Ral 9010 / 9002
Opakowanie	100 szt./ pudełko

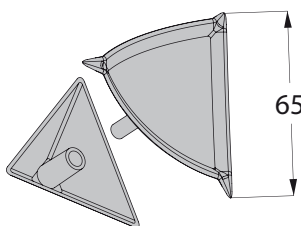

CO3V 65

Materiał	twarde pvc
Kolor	Ral 9010 / 9002
Opakowanie	100 szt./ pudełko

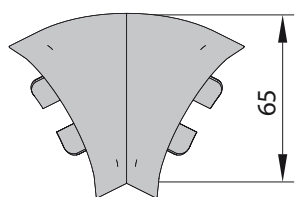

CO2VE 65

Materiał	twarde pvc
Kolor	Ral 9010 / 9002
Opakowanie	100 szt./ pudełko

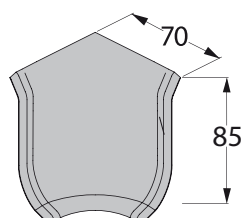

PL2I 85 NH

Materiał	twarde pvc
Kolor	Ral 9010 / 9002
Opakowanie	50 szt./ pudełko

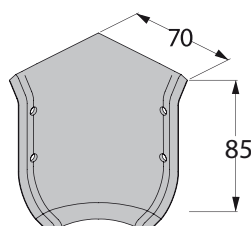

PL2I 85

Do instalacji TS5 strona 54

Materiał	twarde pvc
Kolor	Ral 9010 / 9002
Opakowanie	50 szt./ pudełko

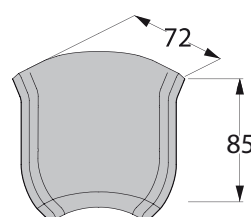

PL3I 85 NH

Materiał	twarde pvc
Kolor	Ral 9010 / 9002
Opakowanie	50 szt./ pudełko

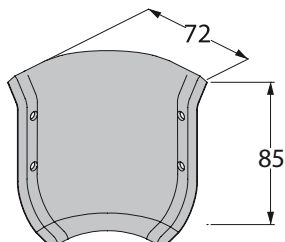

PL3I 85 Do instalacji z TS5 strona 54

Materiał	twarde pvc
Kolor	Ral 9010 / 9002
Opakowanie	50 szt./ pudełko

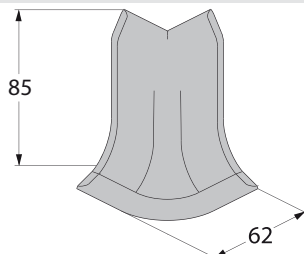

PL2E 85 NH

Materiał	twarde pvc
Kolor	Ral 9010 / 9002
Opakowanie	50 szt./ pudełko

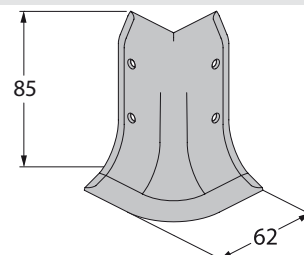

PL2E 85 Do instalacji z TS5 strona 54

Materiał	twarde pvc
Kolor	Ral 9010 / 9002
Opakowanie	50 szt./ pudełko

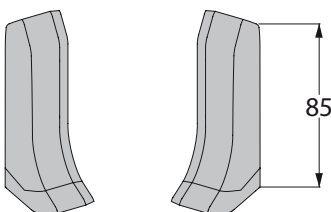

PLTDX 85 / PLTSX 85 NH

Materiał	twarde pvc
Kolor	Ral 9010 / 9002
Opakowanie	100 szt./ pudełko

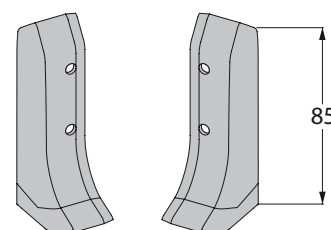

PLTDX 85 / PLTSX 85 Do instalacji z TS5 strona 54

Materiał	twarde pvc
Kolor	Ral 9010 / 9002
Opakowanie	100 szt./ pudełko



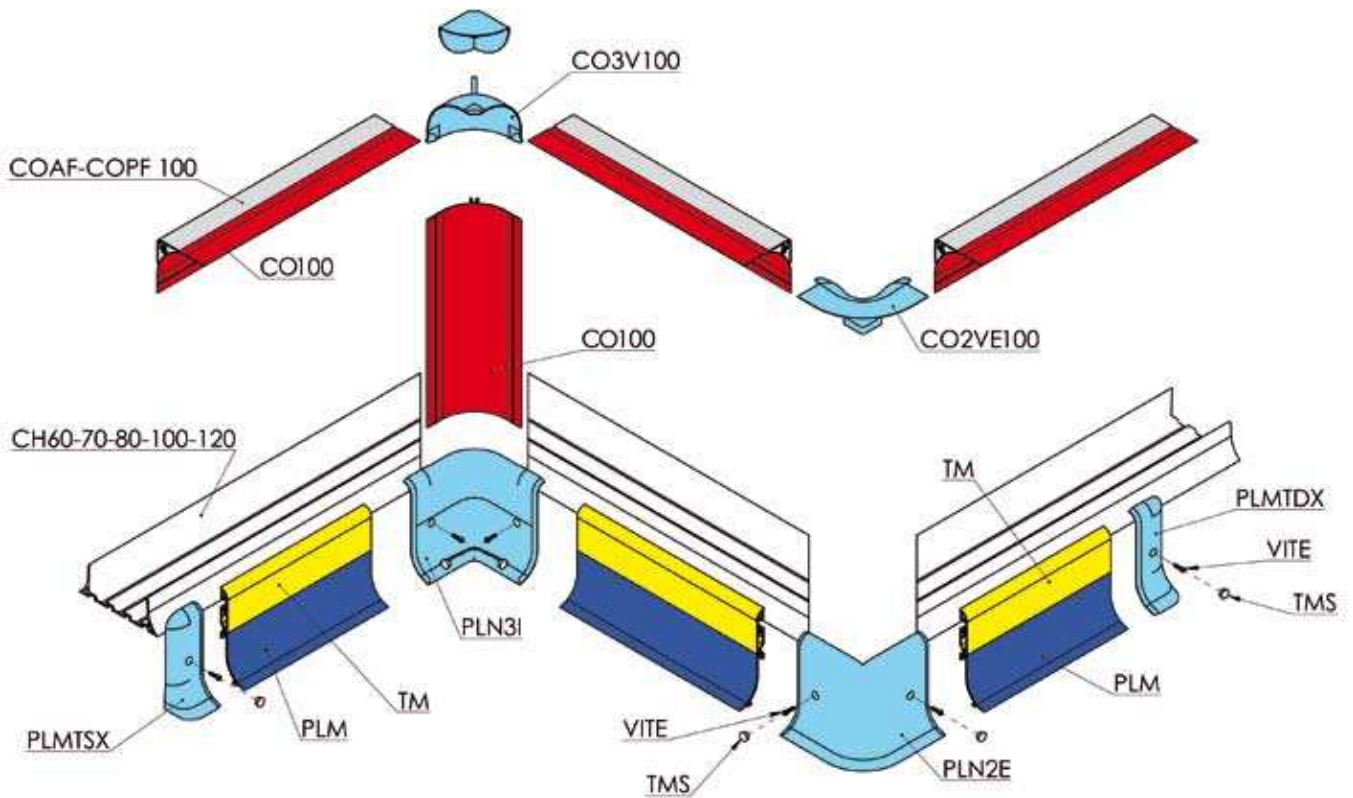

3. System Clean

Idealny wybór pomiędzy systemem standardowym a systemem modułowym, jeden rozmiar wyoblenia - 100 mm, jedna wysokość płaskiej listwy.

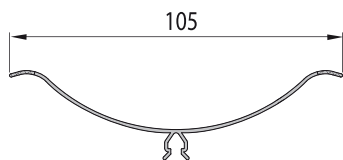

CO 100

Materiał	wielokomponentowe pvc
Kolor	Ral 9010 / 9002
Długość	4.000 mm
Opakowanie	25 szt./ pudełko

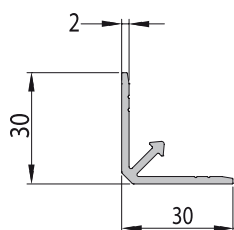

COPF 100-65

Z otworami pod wkręty

Materiał	twarde pvc
Kolor	-----
Długość	4.000 mm
Opakowanie	25 szt./ pudełko

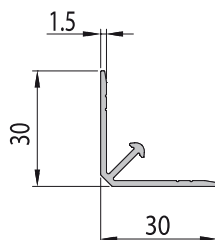

COAF 100-65

Materiał	aluminium
Kolor	aluminium
Długość	4.000 mm
Opakowanie	25 szt./ paczka

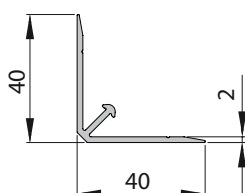

COAF 40

Z otworami pod wkręty

Materiał	aluminium
Kolor	aluminium
Długość	4.000
Opakowanie	25 szt./ paczka

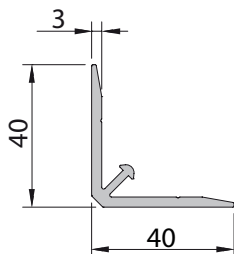
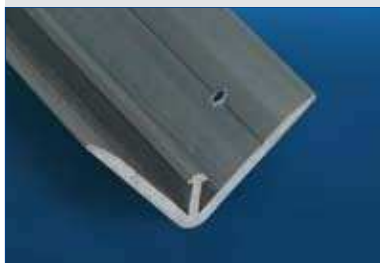

COPF 40

Z otworami pod wkręty

Materiał	twarde pvc
Kolor	-----
Długość	4.000 mm
Opakowanie	25 szt./ pudełko

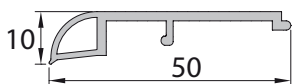

TM

Materiał	wielokomponentowe pvc
Kolor	Ral 9010 / 7040
Długość	4.000 mm
Opakowanie	40 szt./ pudełko

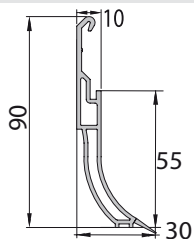

PLM

Materiał	wielokomponentowe pvc
Kolor	Ral 9010 / 7040
Długość	4.000 mm
Opakowanie	10 szt./ pudełko

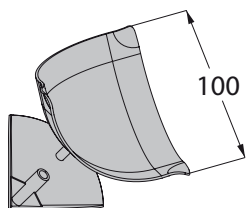

CO3V 100

Materiał	polipropylen
Kolor	Ral 9010 / 9002
Opakowanie	100 szt./ pudełko

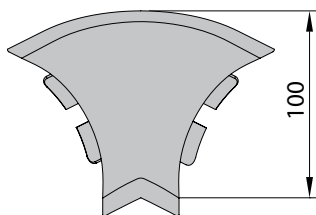

CO2VE 100

Materiał	twarde pvc
Kolor	Ral 9010 / 9002
Opakowanie	100 szt./ pudełko

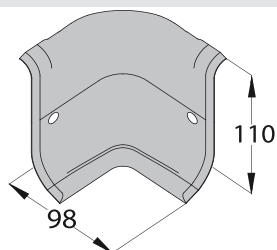

PLN3I 100

Do instalacji z TM5 strona 54

Materiał	twarde pvc
Kolor	Ral 9010 / 7040
Opakowanie	50 szt./ pudełko

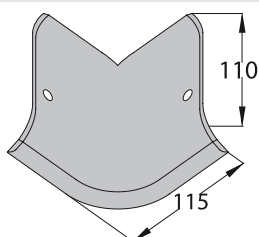

PLN2E 100

Do instalacji z TM5 strona 54

Materiał	twarde pvc
Kolor	Ral 9010 / 7040
Opakowanie	50 szt./ pudełko

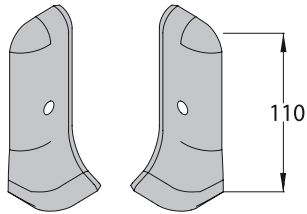

PLMT DX/SX

Do instalacji z TM5 strona 54

Materiał hard pvc

Kolor Ral 9010 / 7040

Opakowanie 100 szt./ pudełko



biały Ral 9010



biały Ral 9002



szary Ral 7040

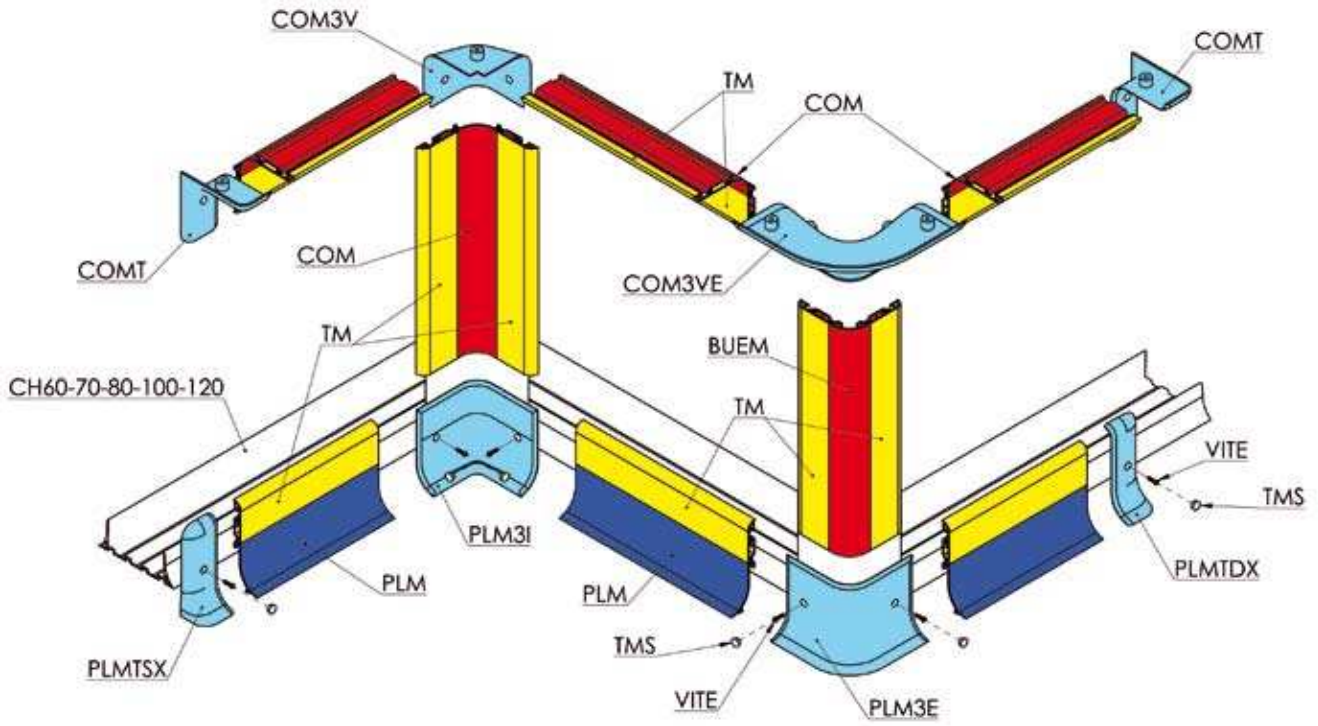

4. System modułowy

System modułowy to system pozwalający dostosować wysokość listwowania do swoich potrzeb. Łatwy i szybki montaż.

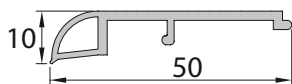

TM

Materiał	wielokomponentowe pvc
Kolor	Ral 9010 / 7040
Długość	4.000 mm
Opakowanie	40 szt./ pudełko

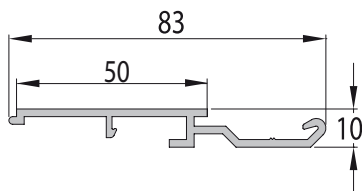

EXM

Materiał	twarde pvc
Kolor	Ral 9010 / 7040
Długość	4.000 mm
Opakowanie	20 szt./ pudełko

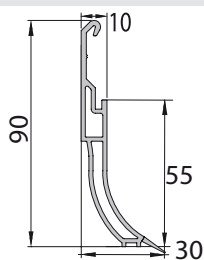

PLM

Materiał	wielokomponentowe pvc
Kolor	Ral 9010 / 7040
Długość	4.000 mm
Opakowanie	10 szt./ pudełko

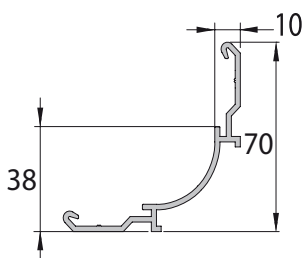

COM

Materiał	twarde pvc
Kolor	Ral 9010 / 7040
Długość	4.000 mm
Opakowanie	10 szt./ pudełko

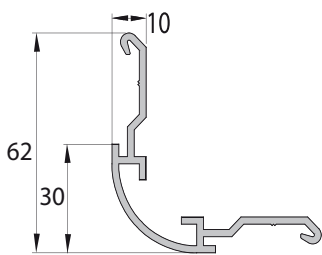

BUEM

Materiał	twarde pvc
Kolor	Ral 9010 / 7040
Długość	4.000 mm
Opakowanie	10 szt./ pudełko

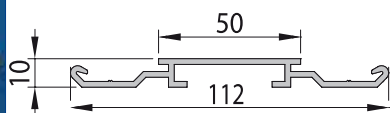

BUM

Materiał	twarde pvc
Kolor	(zobacz poniżej)
Długość	4.000 mm
Opakowanie	8 szt./ pudełko

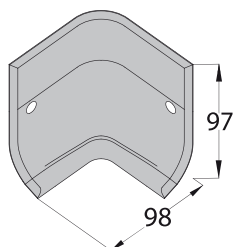

PLM3I Do instalacji z TM5 strona 54

Materiał	hard pvc
Kolor	Ral 9010 / 7040
Opakowanie	50 szt./ pudełko

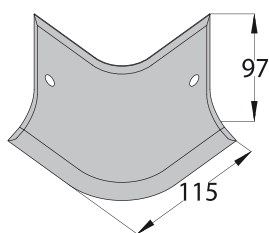

PLM3E Do instalacji z TM5 strona 54

Materiał	twarde pvc
Kolor	Ral 9010 / 7040
Opakowanie	50 szt./ pudełko

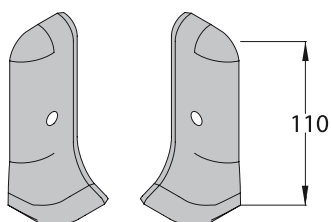

PLMT DX/SX Do instalacji z TM5 strona 54

Materiał	twarde pvc
Kolor	Ral 9010 / 7040
Opakowanie	100 szt./ pudełko

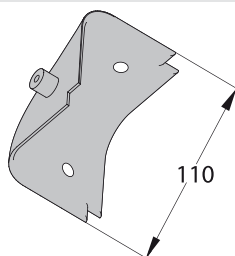

COM3 V Do instalacji z TM5 strona 54

Materiał	twarde pvc
Kolor	Ral 9010 / 7040
Opakowanie	50 szt./ pudełko

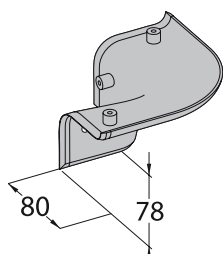

COM3 VE Do instalacji z TM5 strona 54

Materiał	twarde pvc
Kolor	Ral 9010 / 7040
Opakowanie	25 szt./ pudełko

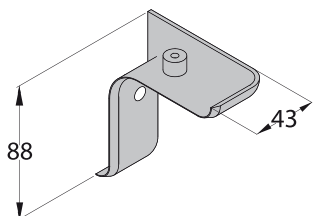

COMT Do instalacji z TM5 strona 54

Materiał	twarde pvc
Kolor	Ral 9010 / 7040
Opakowanie	50 szt./ pudełko

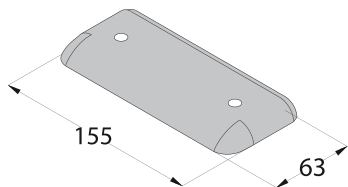

BUMT Do instalacji z TM5 strona 54

Materiał	twarde pvc
Kolor	Ral 9010 / 7040
Opakowanie	50 szt./ pudełko

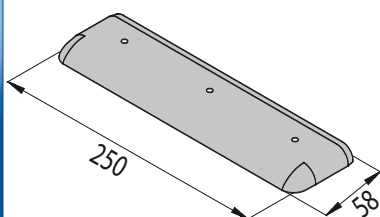

BUMT 250 Do instalacji z TS5 strona 54

Materiał	Abs
Kolor	Ral 9010
Opakowanie	25 szt./ pudełko

 czerwony Ral 3002

 żółty Ral 1023

 biały Ral 9010

 niebieski Ral 5005

 szary Ral 7040

 czarny Ral 9005

 biały Ral 9002

 zielony Ral 6029

Przykład poszerzenia wykończenia EXM

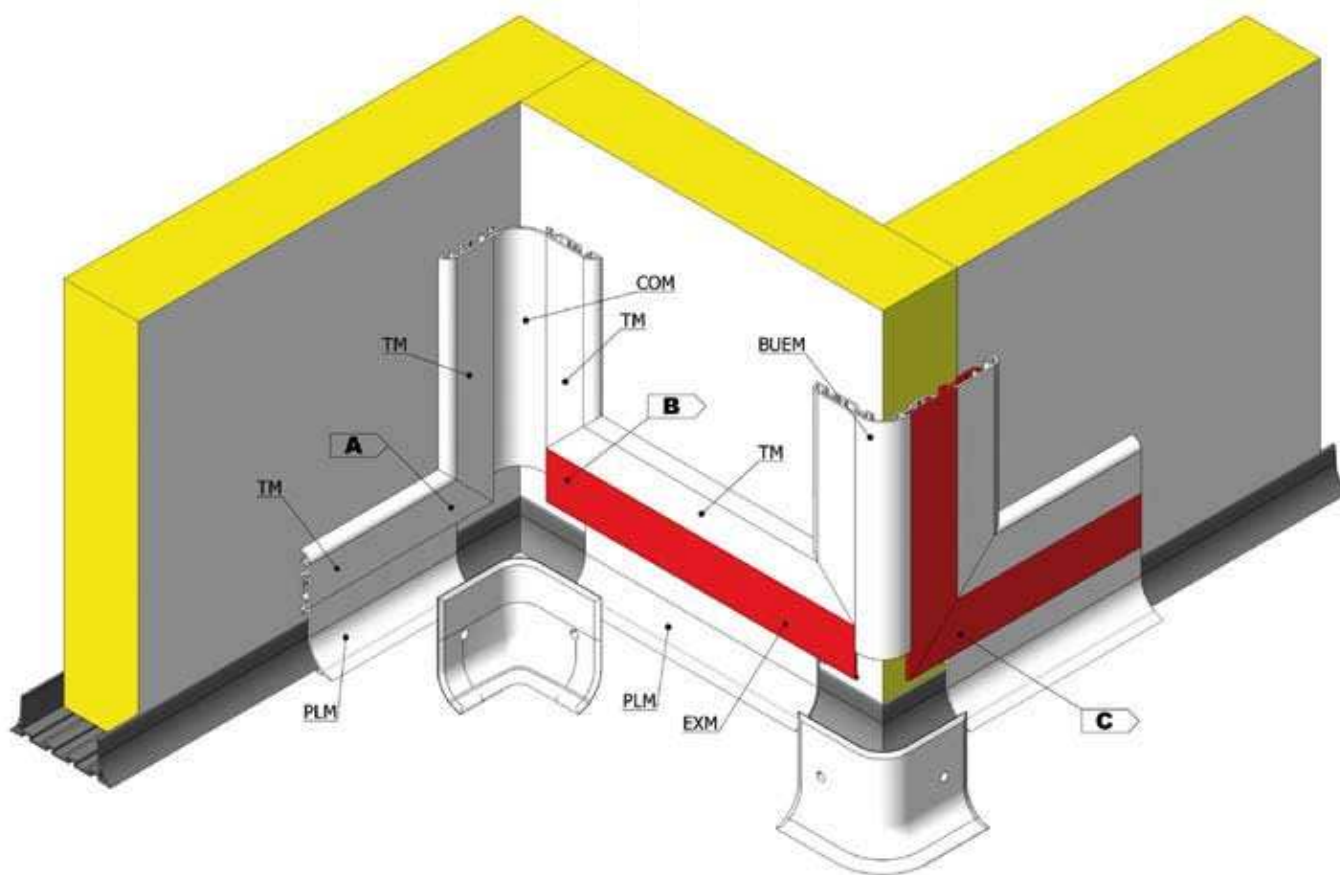

Punkt A

Brak poszerzenia.

Dotnij profil TM pod kątem 45°

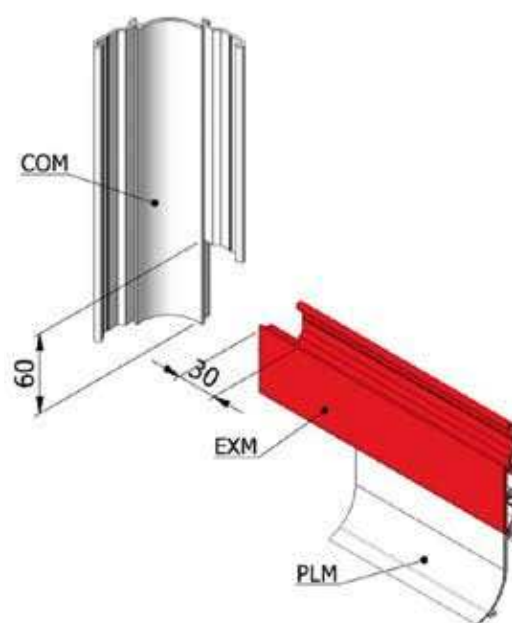

UWAGA: Przed połączeniem należy dokładnie przyciąć profile, zgodnie z rysunkiem.

System modułowy - wersje poszerzeń

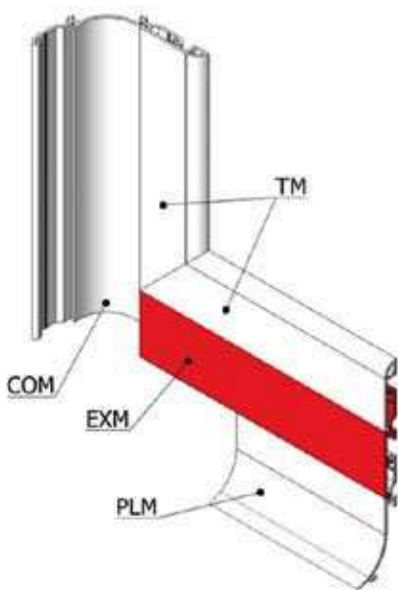
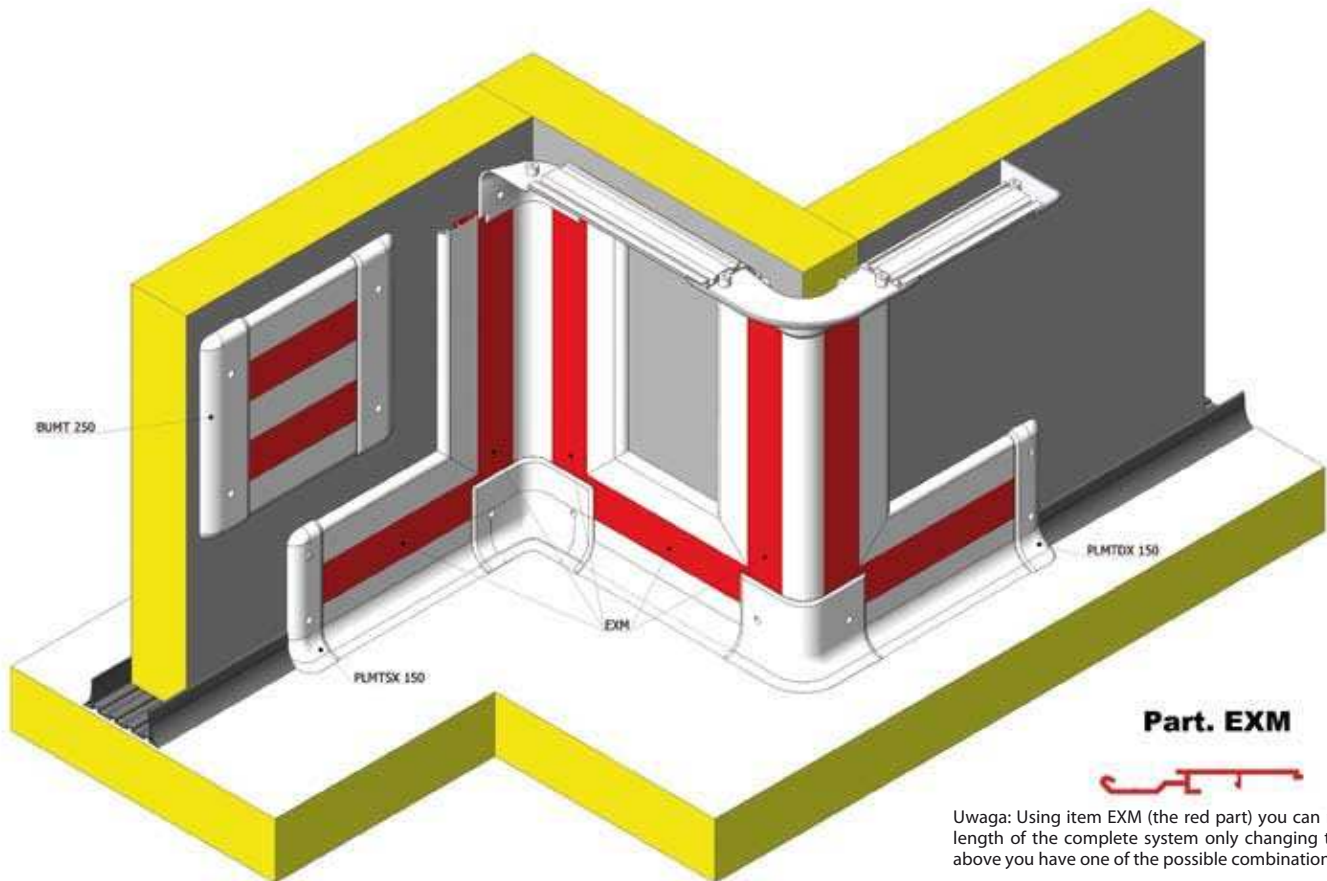

Punkt B

Poszerzenie w jedną stronę
(PIONOWE LUB POZIOME)
Przytnij profil TM pod kątem 45°,
przed połączeniem, musisz wyciąć
profil EXM o 30 mm oraz wyciąć
krótszy narożnik (w tym
przypadku COM) o 60 mm
tak jak to jest pokazane na rysunku.

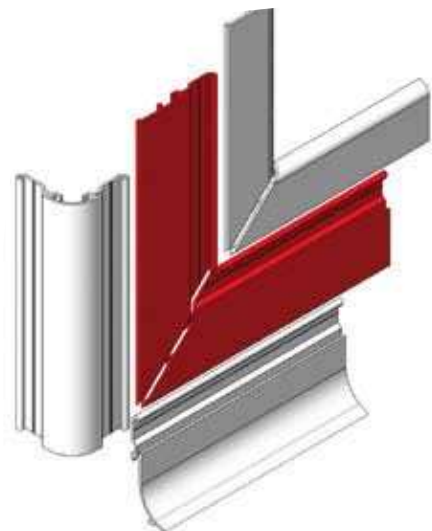

Punkt C

Poszerzenie w obie strony
Przytnij profile TM i EXM pod kątem 45°

Profile startowe
do płyt warstwowych

Channels

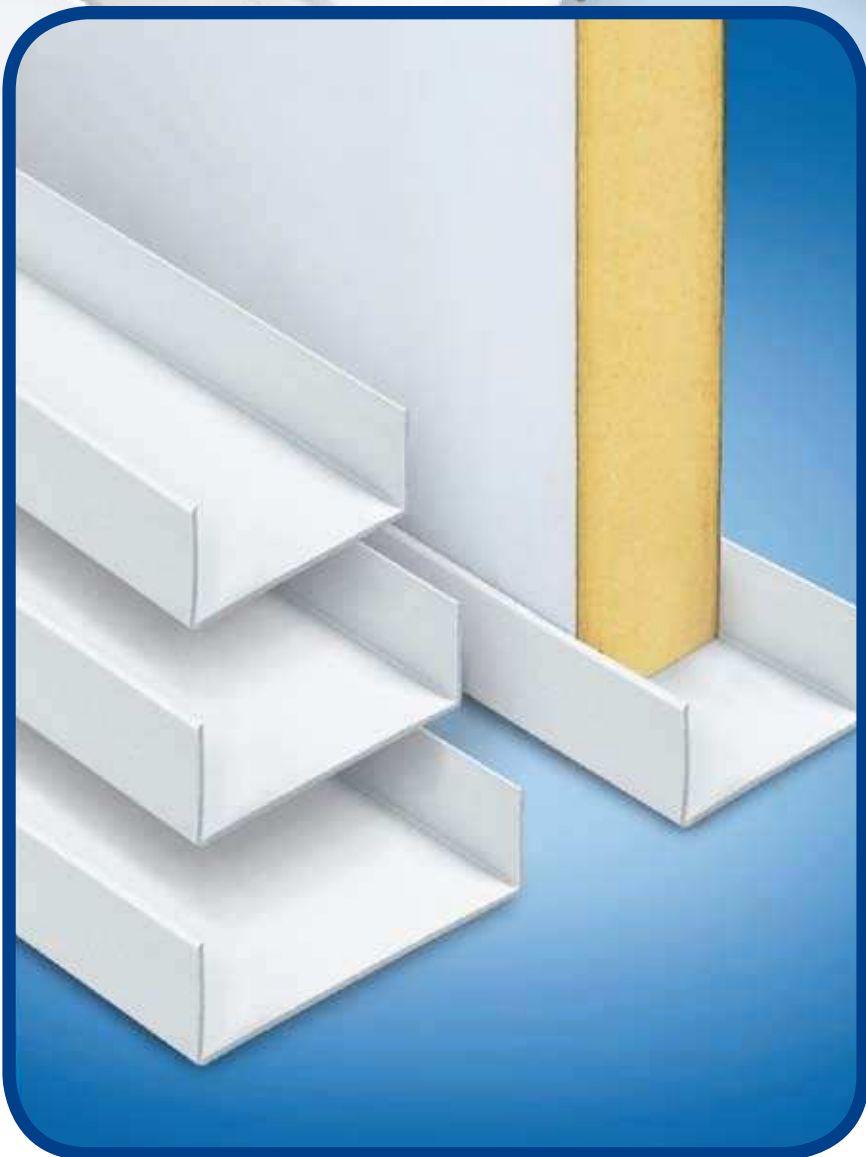

5. Profile startowe do płyt warstwowych

Profile startowe dla płyt warstwowych z różnym rdzeniem i o różnych grubościach płyt.

W przypadku zastosowania profili CH w niektórych sytuacjach można uniknąć dodatkowego listwowania.

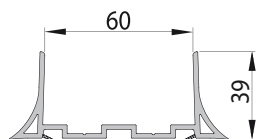

CH 60

Materiał	wielokomponentowe pvc
Kolor	Ral 9010 / 9002
Długość	4.000 mm
Opakowanie	2 szt./ paczka

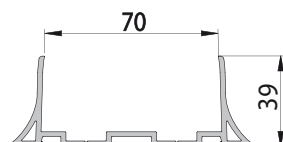

CH 70

Materiał	wielokomponentowe pvc
Kolor	Ral 9010 / 9002
Długość	4.000 mm
Opakowanie	2 szt./ paczka

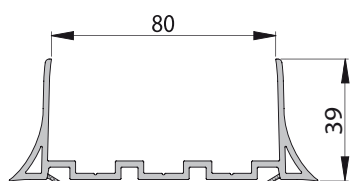

CH 80

Materiał	wielokomponentowe pvc
Kolor	Ral 9010 / 9002
Długość	4.000 mm
Opakowanie	2 szt./ paczka

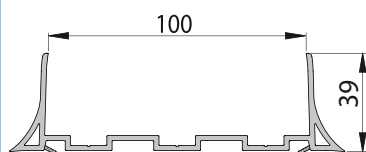

CH 100

Materiał	wielokomponentowe pvc
Kolor	Ral 9010 / 9002
Długość	4.000 mm
Opakowanie	2 szt./ paczka

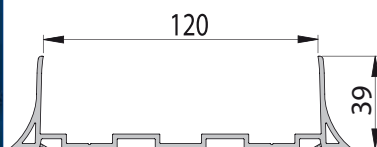

CH 120

Materiał	wielokomponentowe pvc
Kolor	Ral 9010 / 9002
Długość	4.000 mm
Opakowanie	2 szt./ paczka

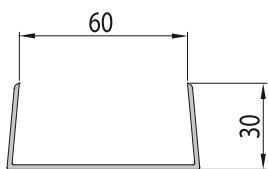
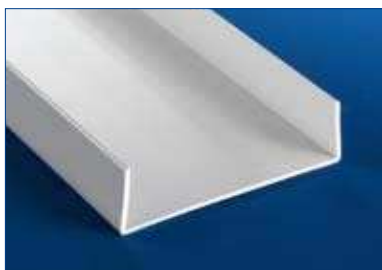

CU 60

Materiał	twarde pvc
Kolor	Ral 9010 / 9002
Długość	4.000 mm
Opakowanie	2 szt./ paczka

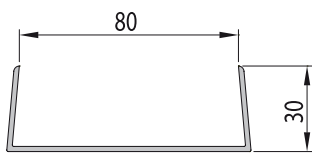

CU 80

Materiał	twarde pvc
Kolor	Ral 9010 / 9002
Długość	4.000 mm
Opakowanie	2 szt./ paczka

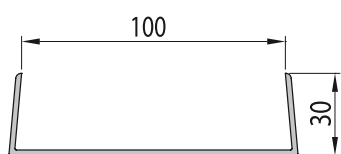

CU 100

Materiał	twarde pvc
Kolor	Ral 9010 / 9002
Długość	4.000 mm
Opakowanie	2 szt./ paczka



biały Ral 9002



biały Ral 9010

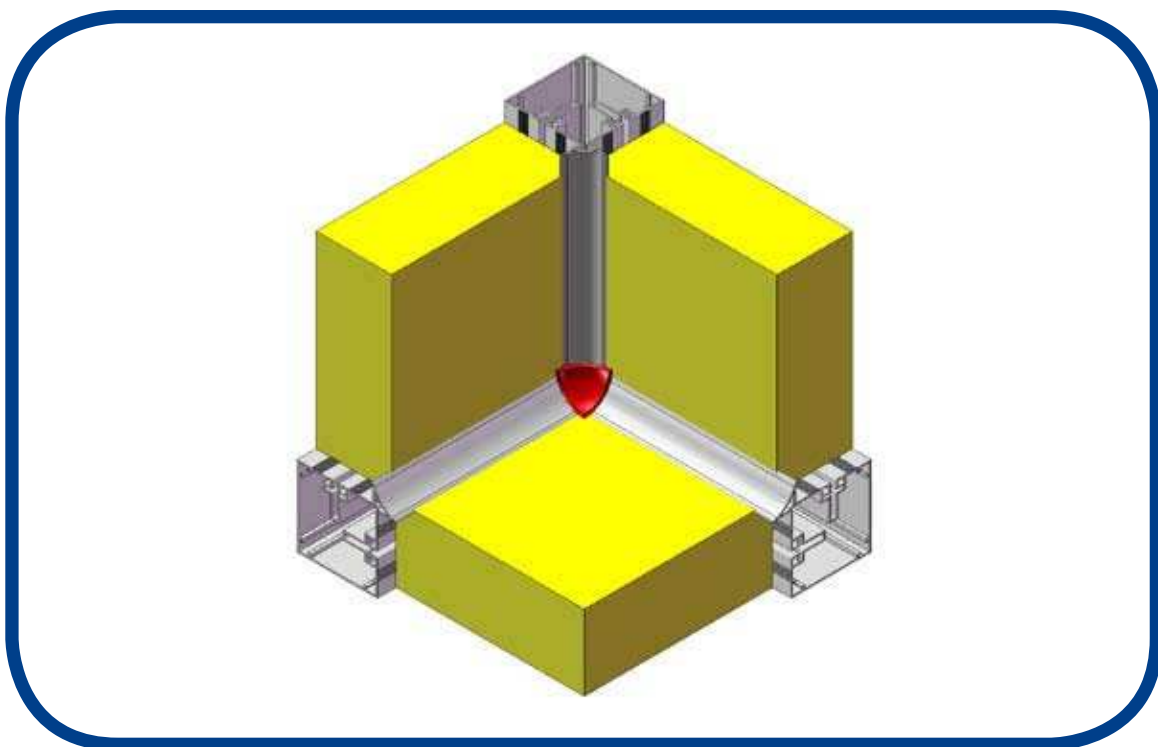

6. System Pillar do budowy chłodni

Prosty i tani system do planowania i budowy komór chłodniczych.

Doskonała termoizolacyjność, wyposażone w wewnętrzne narożniki, które ułatwiają zachowanie czystości w środku pomieszczenia.

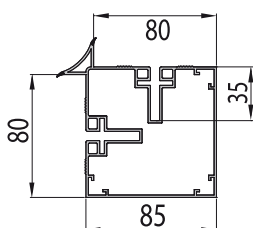

PI 80

Materiał	wielokomponentowe pvc
Kolor	Ral 9010 / 9002
Długość	4.000 mm
Opakowanie	paleta

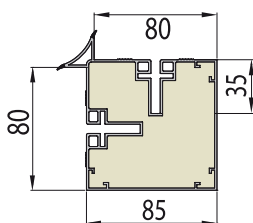

PIF 80 Wypełnienie PUR

Materiał	wielokomponentowe pvc
Kolor	Ral 9010 / 9002
Długość	4.000 mm
Opakowanie	paleta

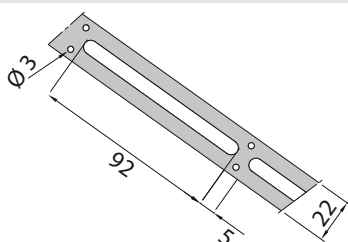

GE

Materiał	stal
Długość	3.000 mm
Opakowanie	25 szt. / paczka

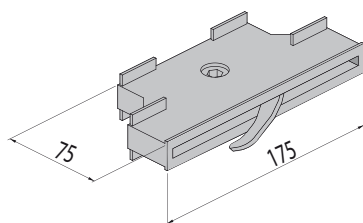

FAM

Materiał	abs + galwanizowana stal
Kolor	Czarny
Opakowanie	100 szt. / pudełko

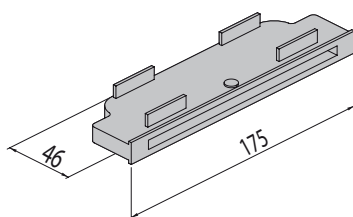
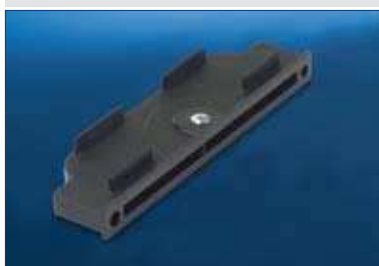

FAF

Materiał	abs + galwanizowana stal
Kolor	Czarny
Opakowanie	100 szt. / pudełko

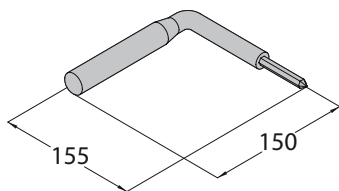

KEY

Materiał abs + metal

Kolor Czarny

Opakowanie -----

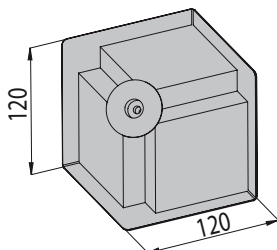

PIC

Materiał PST

Kolor biały

Opakowanie 8 szt. / pudełko

 biały Ral 9002

 biały Ral 9010

Kerb 200

Kerb 2000



7. Listwy przypodłogowe - System Kerb 200

*można instalować z profilami startowymi do płyt warstwowych CH i CU

Listwy przypodłogowe o wysokości H = 200 mm, idealne do ochrony ścian tuż przy podłodze.

Łatwe w montażu. Kompleksowy system - narożniki oraz zakończenia.

Ułatwiają utrzymanie pomieszczeń w czystości.

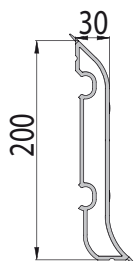

KS 200

Materiał	wielokomponentowe pvc
Kolor	Ral 9010 / 7040
Długość	4.000 mm
Opakowanie	paleta

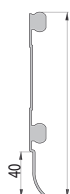

KSAF

Materiał	stal nierdzewna
Kolor	stalowy
Długość	50 mm
Opakowanie	25 szt. / pudełko

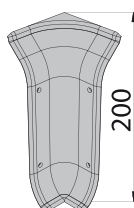

KSI 200

Do instalacji z TK15 strona 54

Materiał	Abs
Kolor	Ral 9010 / 7040
Opakowanie	10 szt. / pudełko

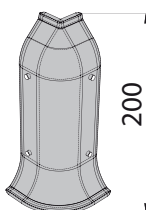

KSE 200

Do instalacji z TK15 strona 54

Materiał	Abs
Kolor	Ral 9010 / 7040
Opakowanie	10 szt./ pudełko

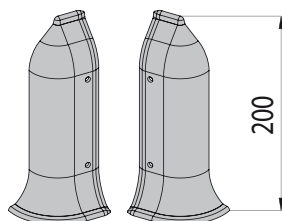

KST 200 DX/SX

Do instalacji z TK15 strona 54

Materiał	Abs
Kolor	Ral 9010 / 7040
Opakowanie	10 szt./ pudełko

 biały Ral 9010

 szary Ral 7040

Wielki Wymiar

Big Dimension



H= 40 cm

Zakres pracy: od - 30° do + 50° C



8. System Rail - wysokie listwy przypodłogowe

Zapewniają doskonałą ochronę ścian przed zniszczeniem.

Łatwe w montażu. Kompletny system wraz z narożnikami oraz zakończeniami.

Ułatwiają utrzymanie pomieszczeń w czystości. Zakres pracy: od -30 st do 50 st C.

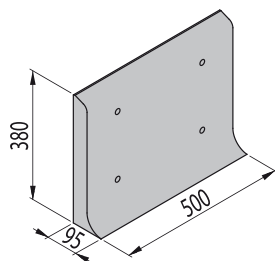

RS 400 Do montażu z TR10 strona 54

Materiał pvc

Kolor Ral 9010

Długość 500 mm

Opakowanie paleta

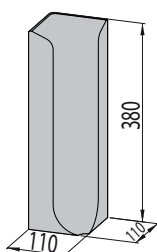

RSI 400

Materiał pvc

Kolor Ral 9010

Opakowanie 10 szt./ pudełko

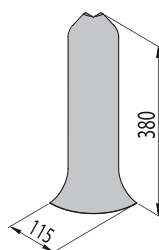

RSE 400 W komplecie klej montażowy

Materiał pvc

Kolor Ral 9010

Opakowanie 10 szt./ pudełko

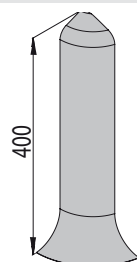

RST 400 DX/SX W komplecie klej montażowy

Materiał Abs

Kolor Ral 9010

Opakowanie 10 szt./ pudełko

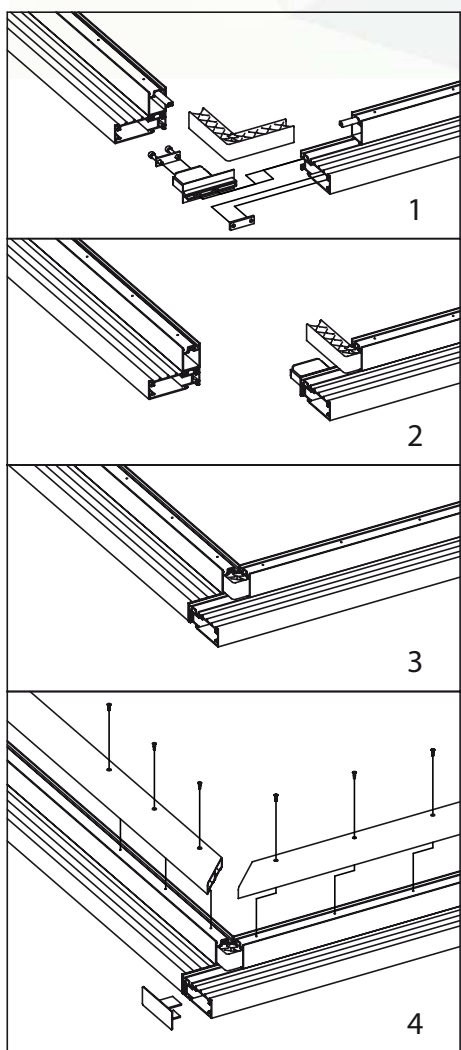
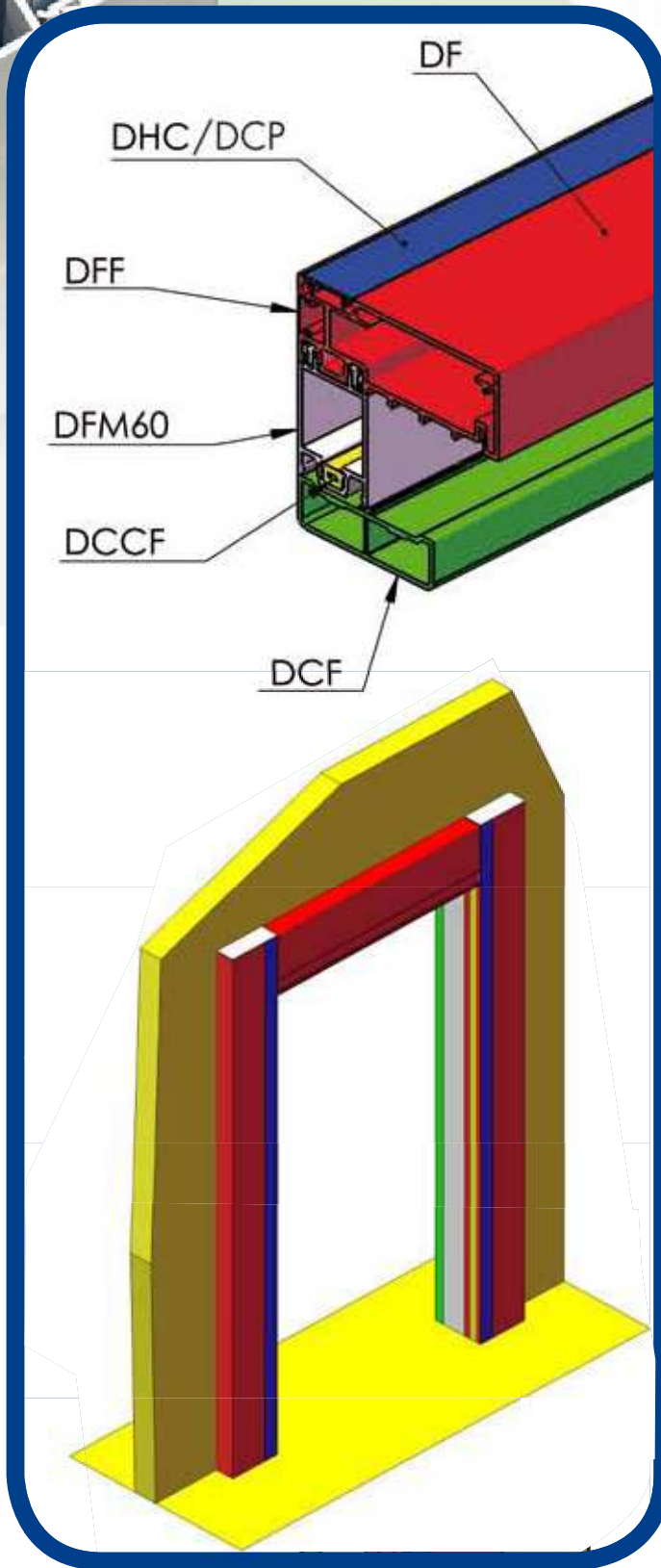

Schemat montażu

9. Modułowy system drzwiowy

Modular system which suits different sizes and thicknesses with possibility to build corners welding or inserting fast connections. It's equipped with spaces for resistance and for additional supports to add during the assembly. It can be covered with plates.

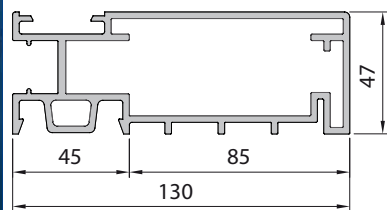

DF

Materiał	twarde pvc
Kolor	biały
Długość	5.400 mm
Opakowanie	2 szt./ paczka

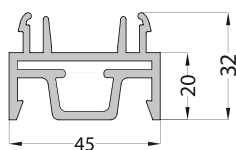

DFM 20

Materiał	twarde pvc
Kolor	biały
Długość	5.400 mm
Opakowanie	4 szt./ paczka

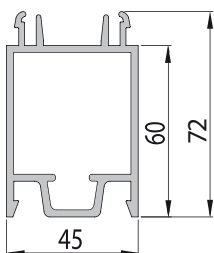

DFM 60

Materiał	twarde pvc
Kolor	biały
Długość	5.400 mm
Opakowanie	2 szt./ paczka

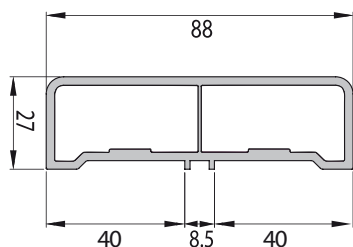

DCF

Materiał	twarde pvc
Kolor	zobacz poniżej
Długość	5.400 mm
Opakowanie	2 szt./ paczka

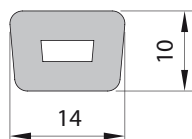

DCCF

Materiał	twarde pvc
Kolor	zobacz poniżej
Długość	5.400 mm
Opakowanie	25 szt. / paczka

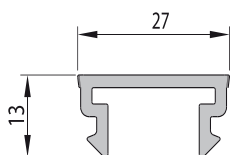

DFF

Materiał	twarde pvc
Kolor	biały
Długość	5.400 mm
Opakowanie	25 szt. / paczka

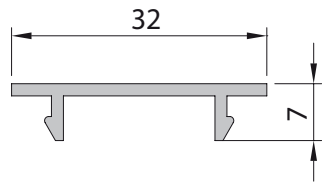

DCP

Materiał	twarde pvc
Kolor	biały
Długość	5.400 mm
Opakowanie	25 szt. / paczka

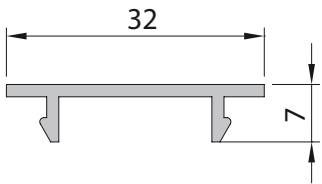

DHC

Materiał	aluminium
Kolor	aluminium
Długość	5.400 mm
Opakowanie	25 szt. / paczka

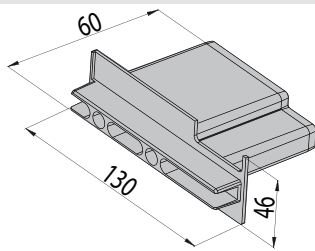

DJF DX/SX

Materiał	pvc
Kolor	biały
Opakowanie	10 szt. / pudełko

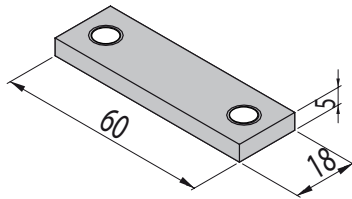

K1

Materiał	stal kwasoodporna
Opakowanie	10 szt. / torebka

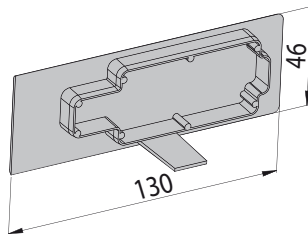

DC DX/SX

Materiał	pvc
Kolor	white
Opakowanie	10 szt. / pudełko

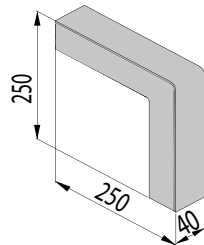

DCA

Materiał	pvc
Kolor	biały
Opakowanie	10 szt. / pudełko

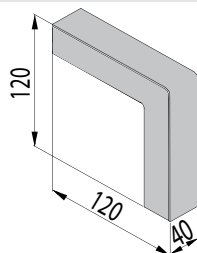

DCAS

Materiał	pvc
Kolor	biały
Opakowanie	20 szt. / pudełko

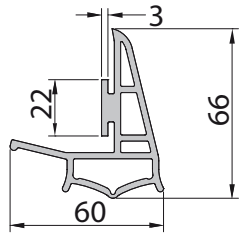
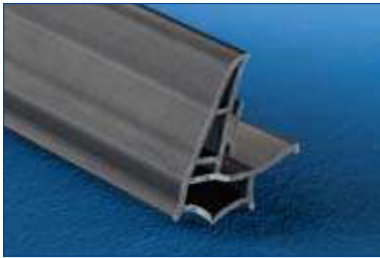

VELA

Materiał	pvc Mg
Kolor	czarny
Długość	4.000 mm
Opakowanie	6 szt./ pudełko

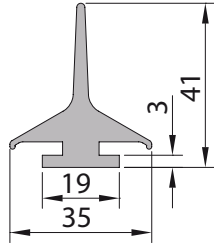

PLANE

Materiał	pvc Mg
Kolor	czarny
Długość	4.000 mm
Opakowanie	15 szt./ pudełko



10. Akcesoria do płyt warstwowych

Dystanse, śruby oraz podkładki.

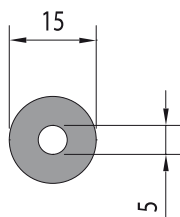

BAR 15

Dla wkręta \varnothing 6,3 mm

Materiał	twarde pvc
Kolor	Ral 9010
Długość	na zapytanie
Opakowanie	paleta

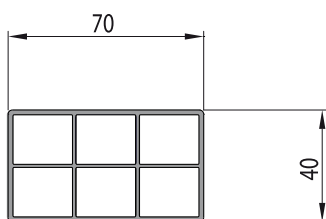

AC 70

Duża wytrzymałość

Materiał	twarde pvc
Kolor	Ral 9010
Długość	4.000 mm
Opakowanie	2 szt./ paczka

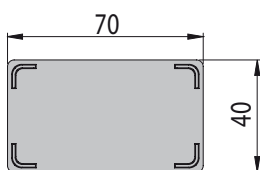

ACT 70

Materiał	twarde pvc
Kolor	Ral 9010
Opakowanie	100 szt./ pudełko

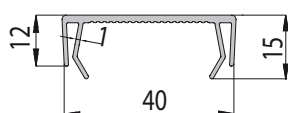
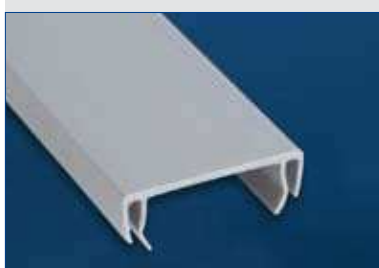

SH 40

Materiał	twarde pvc
Kolor	Ral 7040
Długość	4.000 mm
Opakowanie	32 szt./ pudełko

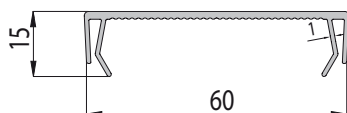
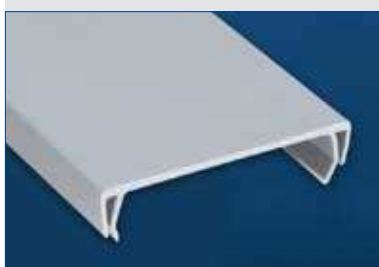

SH 60

Materiał	twarde pvc
Kolor	Ral 7040
Długość	4.000 mm
Opakowanie	25 szt./ pudełko

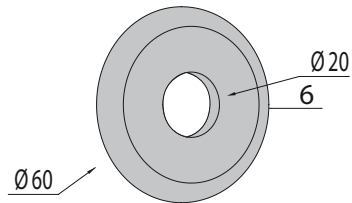

R 60

Materiał	twarde pvc
Kolor	Ral 9010 / 9002
Opakowanie	300 szt./ pudełko

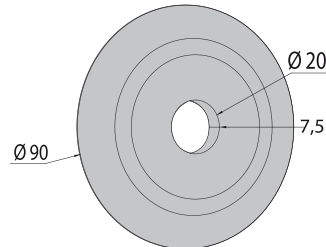

R 90

Materiał	twarde pvc
Kolor	Ral 9010 / 9002
Opakowanie	150 szt./ pudełko

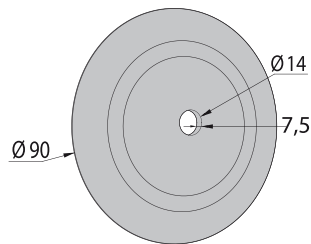

R 90 F 14

Materiał	twarde pvc
Kolor	Ral 9010 / 9002
Opakowanie	150 szt./ pudełko

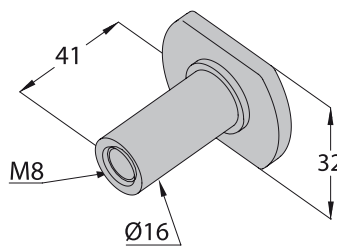

M 8

M 10

M 12

Wytrzymałość	790 Kg	780 Kg	980 Kg
Materiał	twarde pvc		
Kolor	Ral 9010 / 9002		
Opakowanie	300 szt. / pudełko		

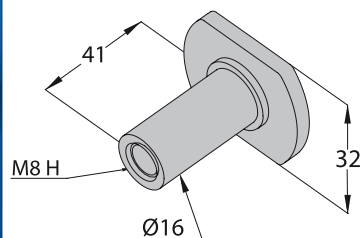

M 8 H

M 10 H

M 12 H

Materiał	twarde pvc
Kolor	Ral 9010 / 9002
Opakowanie	300 szt./ pudełko

● biały Ral 9002

○ biały Ral 9010

● szary Ral 7040

Odboje 50

Bumper 50

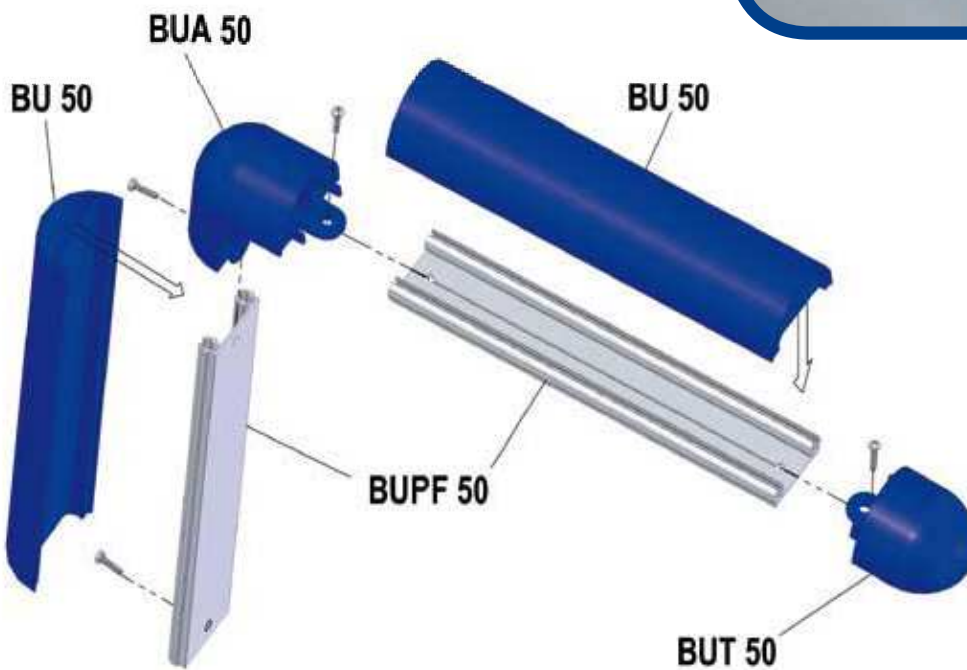

11. Odboje 50

Doskonała ochrona przed uderzeniami, liniowe, funkcjonalne wzornictwo, wysoka odporność, łatwe w montażu. Dostępność w 8 kolorach.

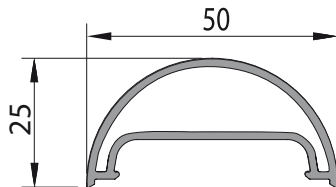

BU 50

Materiał	twarde pvc
Kolor	(zobacz poniżej)
Długość	4.000 mm
Opakowanie	14 szt./ pudełko

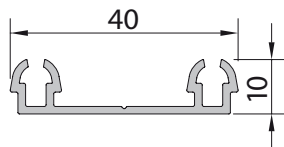

BUPF 50

Materiał	twarde pvc
Kolor	-----
Długość	4.000 mm
Opakowanie	14 szt. / pudełko

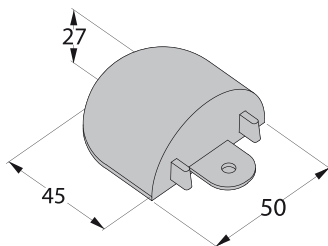

BUT 50

Materiał	twarde pvc
Kolor	(zobacz poniżej)
Opakowanie	100 szt./ pudełko

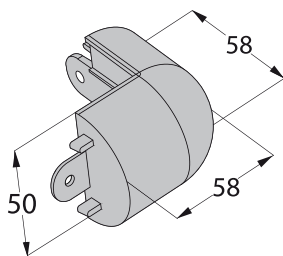

BUA 50

Materiał	twarde pvc
Kolor	(zobacz poniżej)
Opakowanie	50 szt./ pudełko

 czerwony Ral 3002

 żółty Ral 1023

 biały Ral 9010

 niebieski Ral 5005

 szary Ral 7040

 czarny Ral 9005

 biały Ral 9002

 zielony Ral 6029

Odboje 80

Bumper 80

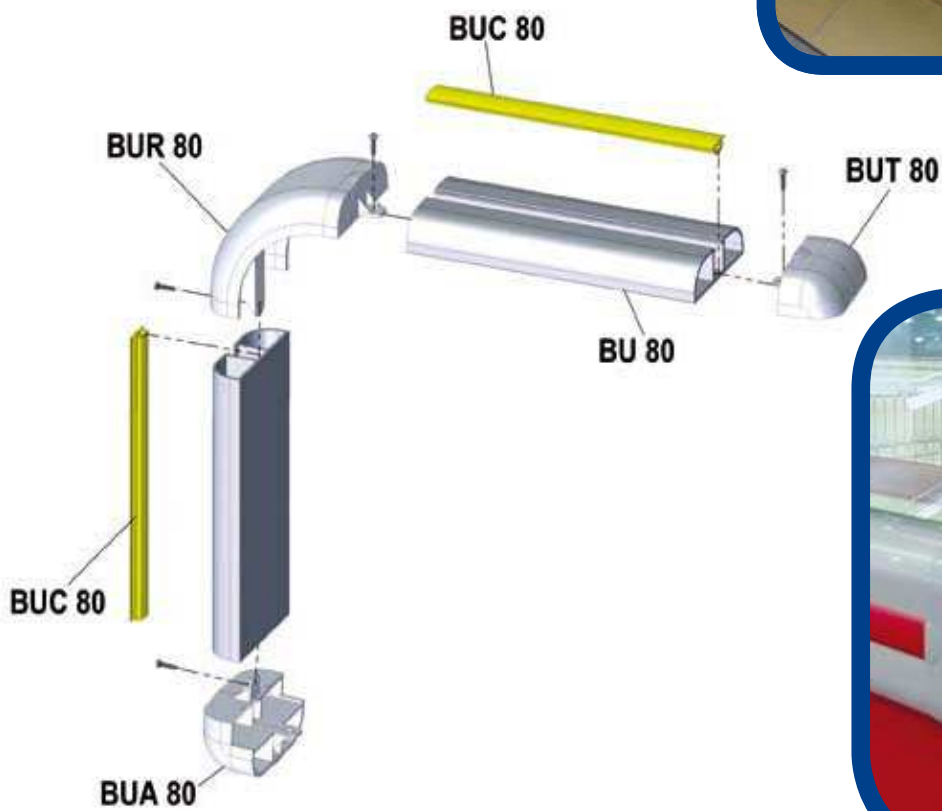

12. Odboje 80

Bezpośredni montaż na powierzchniach - brak dodatkowego profilu prowadzącego przyspiesza instalację.
Wkręty montażowe ukryte są pod ozdobną uszczelką.
Dostępne w 8 wariantach kolorystycznych.

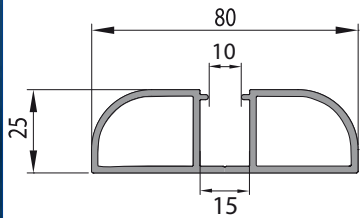

BU 80

Materiał	twarde pvc
Kolor	Ral 7040 / 9010
Długość	4.000 mm
Opakowanie	6 szt./ pudełko

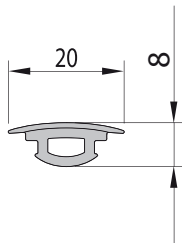

BUC 80

Materiał	wielokomponentowe pvc
Kolor	(zobacz poniżej)
Długość	60 mt. / zwój
Opakowanie	zwój w kartonie

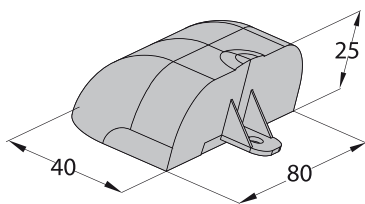

BUT 80

Materiał	twarde pvc
Kolor	Ral 7040 / 9010
Opakowanie	50 szt./ pudełko

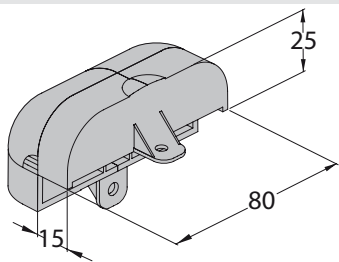

BUA 80

Materiał	twarde pvc
Kolor	Ral 7040 / 9010
Opakowanie	50 szt./ pudełko

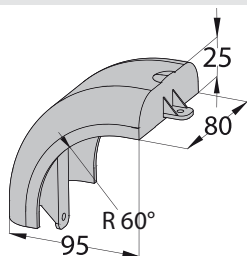

BUR 80

Materiał	twarde pvc
Kolor	Ral 7040
Opakowanie	25 szt./ pudełko

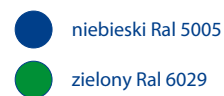
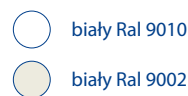
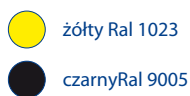
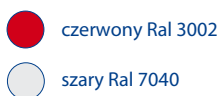

Odboje
elastyczne 80

Bend 80



Opcjonalnie mocowanie na taśmę dwustronnie klejącą

13. Odboje elastyczne 80

Dowolna możliwość kształtowania na zabezpieczanych przedmiotach, doskonałe wzornictwo, brak elementów narożnikowych, szybki montaż. Wypełnienie dostępne w 9 kolorach.

Minimalny promień 100 mm.

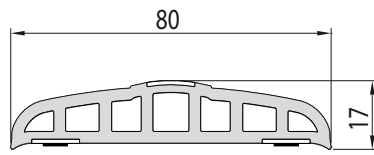
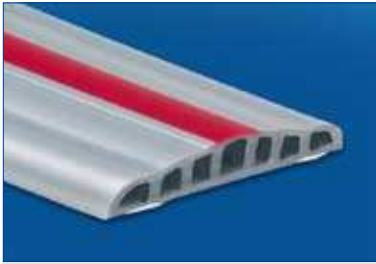

BES 80 Z taśmą dwustronnie klejącą

Materiał	wielokomponentowe pvc
Kolor	srebrny Ral 9006 + kolorowe paski
Opakowanie	1 szt./ pudełko L = 20.000 mm

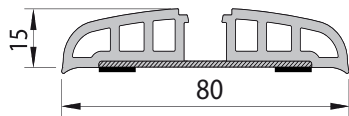

BED 80 Z taśmą dwustronnie klejącą

Materiał	wielokomponentowe pvc
Kolor	srebrny Ral 9006
Opakowanie	1 szt./ pudełko L = 20.000 mm

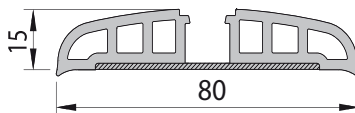

BE 80

Materiał	wielokomponentowe pvc
Kolor	srebrny Ral 9006
Opakowanie	1 szt./ pudełko L = 20.000 mm

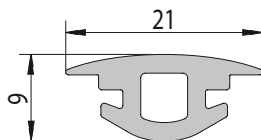

BEC 80

Materiał	miękkie pvc
Kolor	(zobacz poniżej)
Długość	60 mt. / zwój
Packing	zwój w kartonie

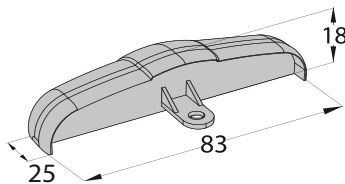

BET 80

Materiał	twarde pvc
Kolor	srebrny Ral 9006
Opakowanie	100 szt./ pudełko

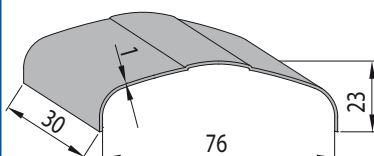

BEJ Z taśmą dwustronnie klejącą

Materiał	PST
Kolor	srebrny Ral 9006
Opakowanie	50 szt./ pudełko

 czerwony Ral 3002

 żółty Ral 1023

 biały Ral 9010

 niebieski Ral 5005

 szary Ral 7040

 czarny Ral 9005

 biały Ral 9002

 zielony Ral 6029

 srebrny Ral 9006



Odboje
system modularny

Bumper Modular



14. Odboje - system modułarny

Nowy system zabezpieczeń z możliwością powiększania powierzchni chronionych.

Łatwy i szybki montaż

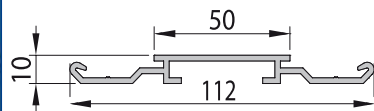

BUM

Materiał	twarde pvc
Kolor	(zobacz poniżej)
Długość	4.000 mm
Opakowanie	8 szt./ pudełko

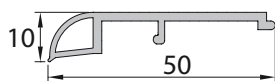

TM

Materiał	wielokomponentowe pvc
Kolor	Ral 9010 / 7040
Długość	4.000 mm
Opakowanie	40 szt./ pudełko

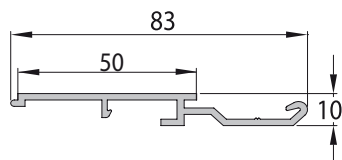

EXM

Materiał	twarde pvc
Kolor	Ral 9010 / 7040
Długość	4.000 mm
Opakowanie	20 szt./ pudełko

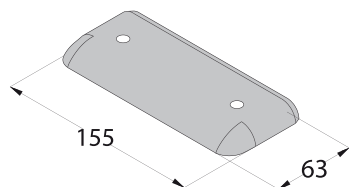

BUMT Do montażu z TM5 strona 54

Materiał	twarde pvc
Kolor	Ral 9010 / 7040
Opakowanie	50 szt./ pudełko

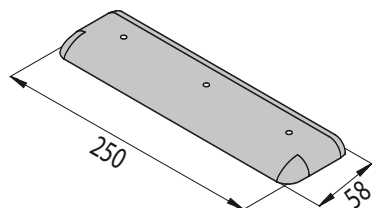

BUMT 250 Do montażu z TS5 strona 54

Materiał	Abs
Kolor	Ral 9010
Opakowanie	25 szt./ pudełko

● czerwony Ral 3002	● żółty Ral 1023	○ biały Ral 9010	● niebieski Ral 5005
○ szary Ral 7040	● czarny Ral 9005	○ biały Ral 9002	● zielony Ral 6029

Odboje - zabezpieczenie ścian

Wall protection System



15. Wall Protection

Szybki i łatwy montaż, brak listwy prowadzącej, doskonale chroni ściany przed uszkodzeniem.

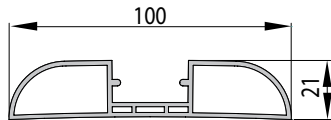

WP 100

Materiał twarde pvc

Kolor Ral 9010 / 9002 / 7040

Długość 4.000 mm

Opakowanie 8 szt./ pudełko

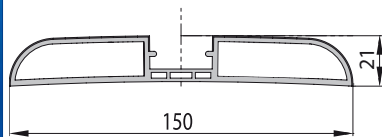

WP 150

Materiał twarde pvc

Kolor Ral 9010 / 9002 / 7040

Długość 4.000 mm

Opakowanie 4 szt./ pudełko

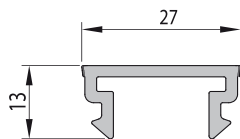

WPC

Materiał wielokomponentowe pvc

Kolor (zobacz poniżej)

Długość 4.000 mm

Opakowanie 16 szt./ pudełko

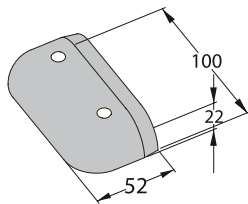

WPT 100

Do montażu z TM5 strona 54

Materiał twarde pvc

Kolor Ral 9010 / 9002 / 7040

Opakowanie 50 szt./ pudełko

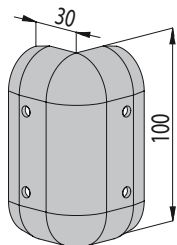

WPA 100

Do montażu z TS5 strona 54

Materiał Poliwęglan

Kolor Ral 9010 / 9002 / 7040

Opakowanie 50 szt./ pudełko

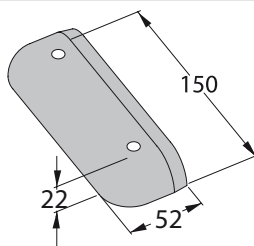

WPT 150

Do montażu z TM5 strona 54

Materiał twarde pvc

Kolor Ral 9010 / 9002 / 7040

Opakowanie 50 szt./ pudełko

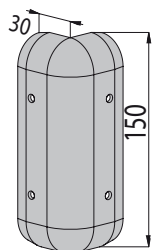

WPA 150 Do montażu z TS5 strona 54

Materiał	Poliwęglan
Kolor	Ral 9010 / 9002 / 7040
Opakowanie	50 szt./ pudełko

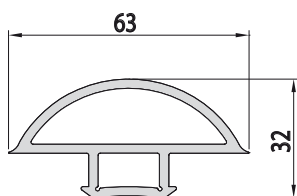

WPCS

Materiał	miękkie pvc
Kolor	(zobacz poniżej)
Długość	4.000 mm

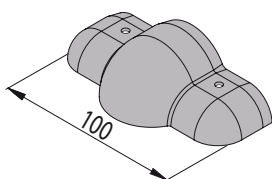

WPTS 100 Do montażu z TS5 strona 54

Materiał	Poliwęglan
Kolor	Ral 9010 / 9002 / 7040
Opakowanie	50 szt./ pudełko

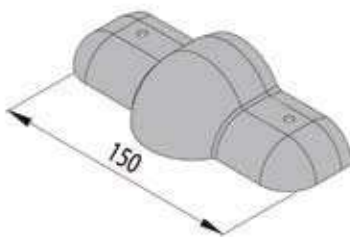

WPTS 150 Do montażu z TS5 strona 54

Materiał	Poliwęglan
Kolor	Ral 9010 / 9002 / 7040
Opakowanie	50 szt./ pudełko

 czerwony Ral 3002

 żółty Ral 1023

 biały Ral 9010

 niebieski Ral 5005

 szary Ral 7040

 czarny Ral 9005

 biały Ral 9002

 zielony Ral 6029

Odboje 150

Bumper 150

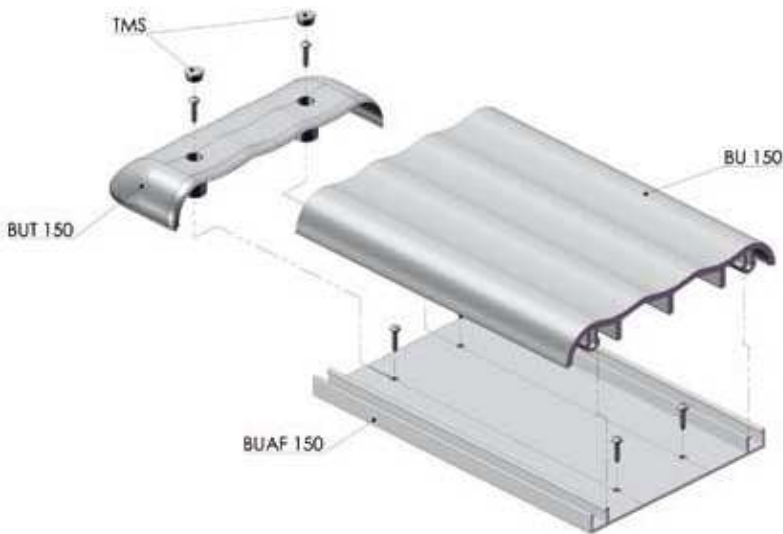

16. Odboje 150

Miękki lecz mocny i trwały.
Innowacyjny i prosty design.

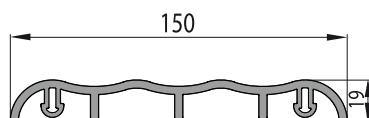

BU 150

Materiał	miękkie pvc
Kolor	Ral 9006
Opakowanie	1 szt./ pudełko L = 25.000 mm

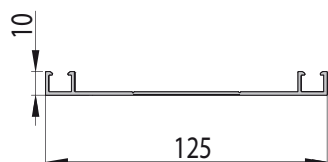

BUAF 150

Materiał	aluminium
Kolor	aluminium
Długość	4.000 mm
Opakowanie	6 szt./ paczka

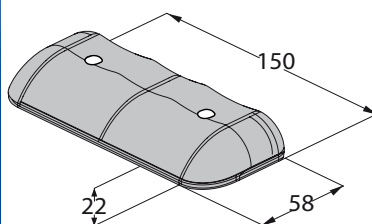

BUT 150

Do montażu z TM5 strona 54

Materiał	twarde pvc
Kolor	Ral 9006
Opakowanie	25 szt./ torba

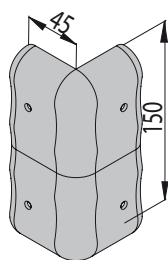

BUA 150

Do montażu z TS15 strona 54

Materiał	Poliwęglan
Kolor	Ral 9006
Opakowanie	50 szt. / pudełko



17. Uszczelki chłodnicze

Uszczelki chłodnicze dostępne w różnych kolorach



FRI 01 A

Materiał	miękkie pvc
Kolor	biały
Długość	2.500 mm
Opakowanie	40 szt. / pudełko



FRI 01 B

Materiał	miękkie pvc
Kolor	biały
Długość	2.500 mm
Opakowanie	40 szt. / pudełko

Fixing accessories

Akcesoria do produktów MPM

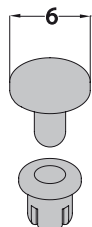

TS3

Materiał	nylon
Kolor	biały
Opakowanie	250 szt./ torba

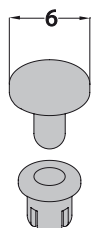

TS5

Materiał	nylon
Kolor	biały
Opakowanie	250 szt./ torba

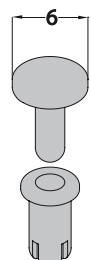

TS15

Materiał	nylon
Kolor	biały
Opakowanie	250 szt./ torba

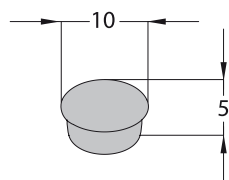

TM5

Materiał	polietylen
Kolor	przezroczyste
Opakowanie	500 szt./ torba

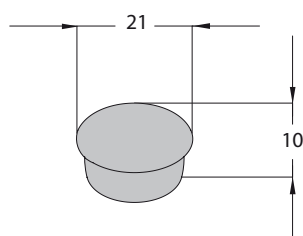

TR10

Materiał	pvc
Kolor	Ral 9010
Opakowanie	100 szt./ torba



TK15

Materiał	nylon
Kolor	biały
Opakowanie	250 szt./ torba