

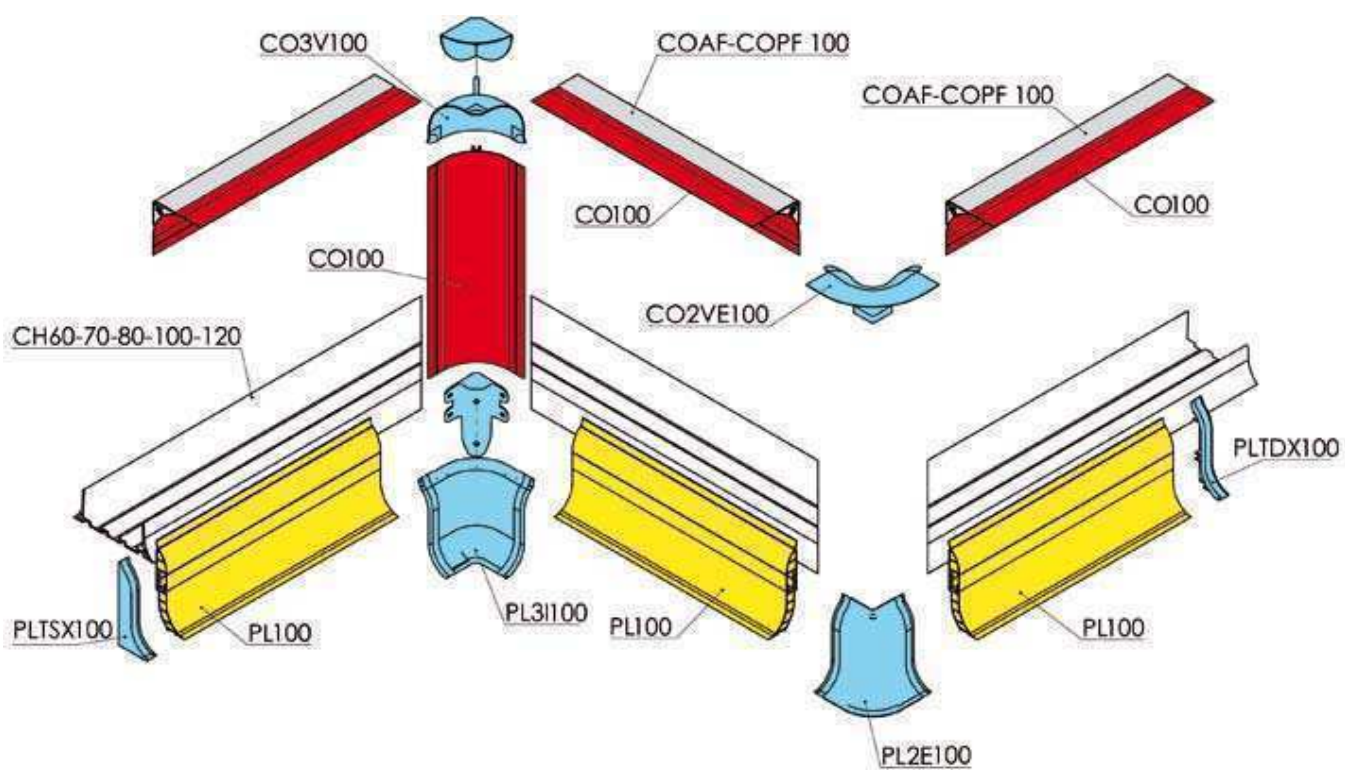

**M.P.M.**  
PLASTIC MATERIALS EXTRUSION

## Profile PVC do chłodzi oraz lad chłodniczych





# 1. System standardowy

Standardowy system wykończeń wyoblonych zgodny z wymogami zasad sanitarno - higienicznych, z miękkim wykończeniem dopasowującym się do podłoża i pozwalającym zachować większą czystość pomieszczeń.

Może być używany w połączeniu z listwami płaskimi PL100.

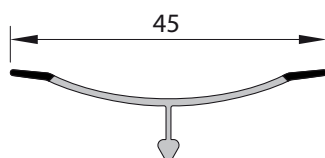

## CS 45

Materiał	wielokomponentowe pvc
Kolor	Ral 9010 / 9002
Długość	4.000 mm
Opakowanie	50 szt./ pudełko

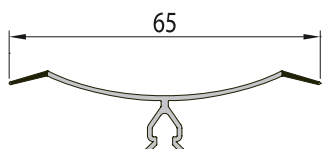

## CO 65

Materiał	wielokomponentowe pvc
Kolor	Ral 9010 / 9002
Długość	4.000 mm
Opakowanie	25 szt./ pudełko

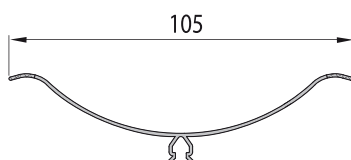

## CO 100

Materiał	wielokomponentowe pvc
Kolor	Ral 9010 / 9002
Długość	4.000 mm
Opakowanie	25 szt./ pudełko

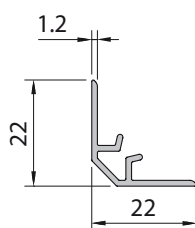

## CSP 45

Materiał	twarde pvc
Kolor	-----
Długość	4.000 mm
Opakowanie	50 szt./ pudełko

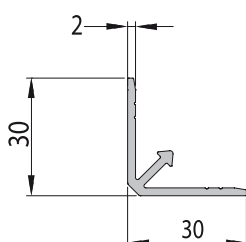

## COPF 100-65

z otworami pod wkręty

Materiał	twarde pvc
Kolor	-----
Długość	4.000 mm
Opakowanie	25 szt./ pudełko

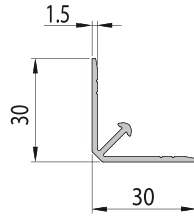

### COAF 100-65

Materiał	aluminium
Kolor	aluminium
Długość	4.000 mm
Opakowanie	25 szt./ paczka

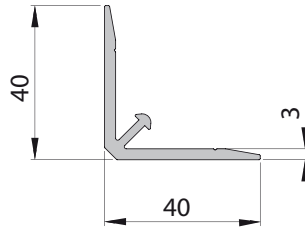

### COPF 40 Z otworami pod wkręty

Materiał	hard pvc
Kolor	various
Długość	4.000 mm
Opakowanie	25 szt./ pudełko

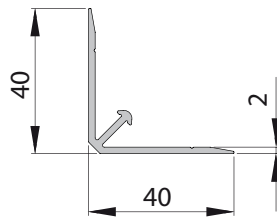

### COAF 40 Z otworami pod wkręty

Materiał	aluminium
Kolor	aluminium
Długość	4.000 mm
Opakowanie	25 szt./ paczka

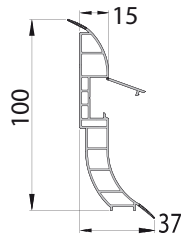

### PL 100

Materiał	wielokomponentowe pvc
Kolor	Ral 9010 / 9002
Długość	4.000 mm
Opakowanie	12 szt./ pudełko

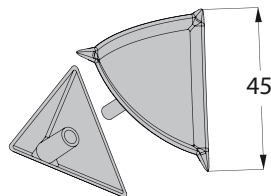
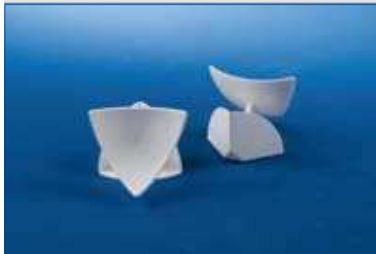

### CO3V 45

Materiał	twarde pvc
Kolor	Ral 9010 / 9002
Opakowanie	100 szt. / pudełko

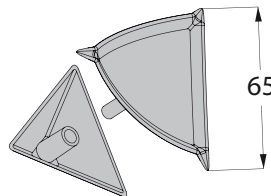

### CO3V 65

Materiał	twarde pvc
Kolor	Ral 9010 / 9002
Opakowanie	100 szt. / pudełko

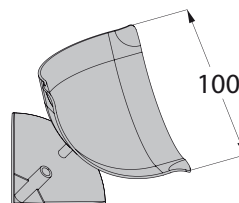

### CO3V 100

Materiał	polipropylen
Kolor	Ral 9010 / 9002
Opakowanie	100 pcs./ pudełko

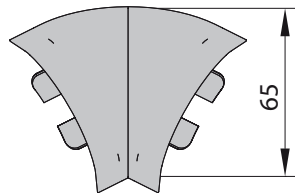

### CO2VE 65

Materiał	twarde pvc
Kolor	Ral 9010 / 9002
Opakowanie	100 szt./ pudełko

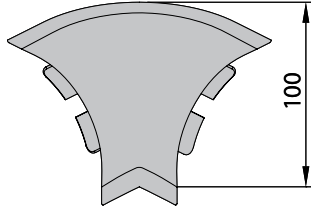

### CO2VE 100

Materiał	twarde pvc
Kolor	Ral 9010 / 9002
Opakowanie	100 szt./ pudełko

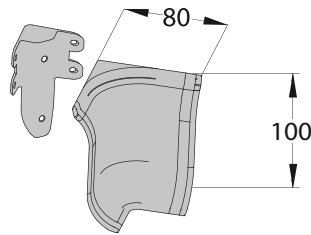

### PL2I 100

Materiał	twarde pvc
Kolor	Ral 9010 / 9002
Opakowanie	50 szt./ pudełko

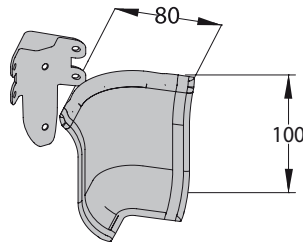

### PL3I 100

Materiał	twarde pvc
Kolor	Ral 9010 / 9002
Opakowanie	50 szt./ pudełko

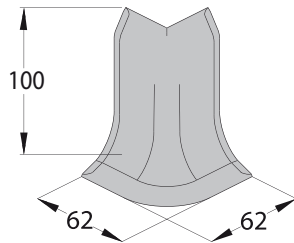

### PL2E 100

Materiał	twarde pvc
Kolor	Ral 9010 / 9002
Opakowanie	50 szt./ pudełko

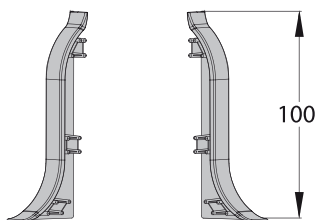

### PLTDX 100 / PLTSX 100

Materiał	twarde pvc
Kolor	Ral 9010 / 9002
Opakowanie	100 szt./ pudełko



biały Ral 9002



biały Ral 9010